

Master Thesis



**Czech
Technical
University
in Prague**

F3

**Faculty of Electrical Engineering
Department of Measurement**

Learning and automation GPIO platform

Ondřej Hruška

**Supervisor: doc. Ing. Radislav Šmíd, Ph.D.
Field of study: Cybernetics and Robotics
Subfield: Sensors and Instrumentation
2018**



MASTER'S THESIS ASSIGNMENT

I. Personal and study details

Student's name: **Hruška Ondřej** Personal ID number: **420010**
Faculty / Institute: **Faculty of Electrical Engineering**
Department / Institute: **Department of Measurement**
Study program: **Cybernetics and Robotics**
Branch of study: **Sensors and Instrumentation**

II. Master's thesis details

Master's thesis title in English:

Learning and Automation GPIO Platform

Master's thesis title in Czech:

Výuková a automatizační GPIO platforma

Guidelines:

Design and implement a modular system consisting of a motherboard and additional modules for connecting sensors, actuators and general inputs via I2C, SPI, UART, 1-Wire or other interfaces to the central system via USB, UART, and wireless interfaces. Allow access to built-in processor peripherals such as ADC, DAC, and timers (PWM, frequency measurement). Design a comfortable way to set the configuration without firmware changes. For the designed system, create a service library in C, Python, and MATLAB.

Bibliography / sources:

- [1] STMicroelectronics datasheets, <http://www.st.com>
- [2] Ganssle, J.: The Art of Designing Embedded Systems, Elsevier Science, 2008.
- [3] Chi, Qingping & Yan, Hairong & Zhang, Chuan & Pang, Zhibo & Da Xu, Li. (2014).: A Reconfigurable Smart Sensor Interface for Industrial WSN in IoT Environment. Industrial Informatics, IEEE Transactions on. 10. 1417-1425. 10.1109/TII.2014.2306798.

Name and workplace of master's thesis supervisor:

doc. Ing. Radislav Šmíd, Ph.D., Department of Measurement, FEL

Name and workplace of second master's thesis supervisor or consultant:

Date of master's thesis assignment: **10.01.2018** Deadline for master's thesis submission: _____

Assignment valid until:
by the end of summer semester 2018/2019

doc. Ing. Radislav Šmíd, Ph.D.
Supervisor's signature

Head of department's signature

prof. Ing. Pavel Ripka, CSc.
Dean's signature

III. Assignment receipt

The student acknowledges that the master's thesis is an individual work. The student must produce his thesis without the assistance of others, with the exception of provided consultations. Within the master's thesis, the author must state the names of consultants and include a list of references.

Date of assignment receipt

Student's signature

Declaration

Prohlašuji, že jsem předloženou práci vypracoval samostatně a že jsem uvedl veškeré použité informační zdroje v souladu s Metodickým pokynem o dodržování etických principů při přípravě vysokoškolských závěrečných prací.

V Praze, 27. května 2018

.....

Acknowledgements

blabla

Abstract

This thesis documents the development of a general purpose software and hardware platform for interfacing low level hardware from high level programming languages and applications run on a PC, using USB and also wirelessly.

The requirements of common engineering tasks and problems occurring in the university environment were evaluated to design an extensible, reconfigurable hardware module that would make a practical, versatile, and low cost tool that in some cases also eliminates the need for professional measurement and testing equipment.

Several hardware prototypes and control libraries in programming languages C and Python have been developed. The Python library additionally integrates with MATLAB scripts. The devices provide access to a range of hardware buses and low level features and can be reconfigured using configuration files stored inside its permanent memory.

Keywords:

Supervisor: doc. Ing. Radislav Šmíd, Ph.D.

Abstrakt

Tato práce popisuje vývoj univerzální softwarové a hardwarové platformy pro přístup k hardwarovým sběrnicím a elektrickým obvodům z prostředí vysokoúrovňových programovacích jazyků a aplikací běžících na PC, a to za využití USB a také bezdrátově.

Byly vyhodnoceny požadavky typických problémů, vyskytujících se v praxi při práci s vestavěnými systémy a ve výuce, pro návrh snadno rozšiřitelného a přenastavitelného hardwarového modulu který bude praktickým, pohodlným a dostupným nástrojem který navíc v některých případech může nahradit profesionální laboratorní přístroje.

Bylo navrženo několik prototypů hardwarových modulů, spolu s obslužnými knihovnamí v jazycích C a Python; k modulu lze také přistupovat z prostředí MATLAB. Přístroj umožňuje přístup k většině běžných hardwarových sběrnic a umožňuje také např. měřit frekvenci a vzorkovat či generovat analogové signály.

Klíčová slova:

Překlad názvu: Výuková a automatizační GPIO platforma

Contents

Part I Introduction

1 Motivation	3
1.1 The Project's Expected Outcome	4
2 Requirement Analysis	5
2.1 Desired Features	5
2.1.1 Interfacing Intelligent Modules	5
2.1.2 Analog Signal Acquisition	6
2.1.3 Analog Signal Output	6
2.1.4 Logic Level Input and Output	6
2.1.5 Pulse Generation and Measurement	6
2.2 Host Computer Connection	7
2.2.1 Communication Interface	7
2.2.2 Configuration Files	7
2.3 An Overview of Planned Features	7
2.4 Microcontroller Selection	8
2.5 Form Factor Considerations	8
3 Existing Solutions	11
3.1 Raspberry Pi	11
3.2 Bus Pirate	12
3.3 Professional DAQ Modules	12

Part II Theoretical Background

4 Universal Serial Bus	17
4.1 Basic Principles and Terminology	17
4.1.1 Pipes and Endpoints	17
4.1.2 Transfer Types	18
4.1.3 Interfaces and Classes	18
4.1.4 Descriptors	19
4.2 USB Physical Layer	21

4.3 USB Classes	22
4.3.1 Mass Storage Class	22
4.3.2 CDC/ACM Class	22
4.3.3 Interface Association: Composite Class	23
5 FreeRTOS	25
5.1 Basic FreeRTOS Concepts and Functions	25
5.1.1 Tasks	25
5.1.2 Synchronization Objects	26
5.2 Stack Overflow Protection	27
6 The FAT16 File System and Its Emulation	29
6.1 The General Structure of the FAT File System	29
6.1.1 Boot Sector	29
6.1.2 File Allocation Table	30
6.1.3 Root Directory	30
6.2 FAT16 Emulation	31
6.2.1 DAPLink Emulator	32
6.2.2 Handling a Read Access	32
6.2.3 Handling a Write Access	33
6.2.4 File Name Change	33
6.2.5 File Creation	34
6.2.6 File Content Change	34
7 Supported Hardware Buses	35
7.1 UART and USART	35
7.1.1 Examples of Devices Using UART	36
7.2 SPI	36
7.2.1 Examples of Devices Using SPI	37
7.3 I ² C	38
7.3.1 Examples of Devices Using I ² C	39
7.4 1-Wire	39
7.4.1 Examples of Devices Using 1-Wire	40

7.5 NeoPixel	40
8 Non-communication Hardware Functions	43
8.1 Frequency Measurement	43
8.2 Analog Signal Acquisition	45
8.3 Waveform Generation	46
8.3.1 Waveform Generation with DMA and a Timer	46
8.3.2 Direct Digital Synthesis	47
8.4 Touch Sensing	48
Part III	
Implementation	
9 Application Structure	53
9.1 User's View of GEX	53
9.1.1 Updating GEX Settings	54
9.1.2 Connecting Using the Wireless Module	54
9.1.3 Using the Control Interface	54
9.2 Internal Structure Block Diagram	55
9.3 FreeRTOS Synchronization Objects Usage	56
9.3.1 Message and Job Queue	56
9.4 Functional Blocks	56
9.5 Source Code Layout	57
9.6 Functions of the Core Framework	57
9.6.1 Resource Allocation	58
9.6.2 Settings Storage	58
9.6.3 Communication Ports	59
9.6.4 Message Passing	60
9.6.5 Interrupt Routing	60
10 Communication Protocol	63
10.1 Frame Structure	63
10.2 Message Listeners	64
10.3 Designated Frame Types	64

10.4 Bulk Read and Write Transactions	65
10.4.1 Bulk Read	65
10.4.2 Bulk Write	66
10.4.3 Persisting the Changed Configuration to Flash	67
10.5 Reading a List of Units	67
10.6 Unit Requests and Reports	67
10.6.1 Unit Requests	67
10.6.2 Unit Reports	68
11 Wireless Interface	69
11.1 Modulations Overview	69
11.1.1 On-Off Keying (OOK)	70
11.1.2 Frequency Shift Keying (FSK)	70
11.1.3 Gaussian Frequency Shift Keying (GFSK)	70
11.1.4 Minimum-Shift Keying (MSK)	70
11.1.5 Gaussian Minimum-Shift Keying (GMSK)	70
11.1.6 LoRa Modulation	70
11.2 Comparing SX1276 and nRF24L01+	70
11.3 Integration of the nRF24L01+ into GEX	71
11.3.1 The Wireless Gateway Protocol	72
11.3.2 Gateway Initialization Procedure	73
12 Units Overview, Commands and Events Description	75
12.1 Naming Conventions and Common Principles	75
12.1.1 Unit Naming	75
12.1.2 Packed Pin Access	75
12.2 Digital Output	76
12.2.1 Digital Output Configuration	76
12.2.2 Digital Output Commands	76
12.3 Digital Input	77
12.3.1 Digital Input Configuration	77
12.3.2 Digital Input Events	78
12.3.3 Digital Input Commands	78

12.4 SIPO (Shift Register) Unit	78
12.4.1 SIPO Configuration	79
12.4.2 SIPO Commands	79
12.5 NeoPixel Unit	79
12.5.1 NeoPixel Configuration	80
12.5.2 NeoPixel Commands	80
12.6 SPI Unit	81
12.6.1 SPI Configuration	81
12.6.2 SPI Commands	82
12.7 I ² C Unit	82
12.7.1 I ² C Configuration	82
12.7.2 I ² C Commands	82
12.8 USART Unit	83
12.8.1 USART Configuration	83
12.8.2 USART Events	84
12.8.3 USART Commands	84
12.9 1-Wire Unit	85
12.9.1 1-Wire Configuration	85
12.9.2 1-Wire Commands	85
12.10 Frequency Capture Unit	86
12.10.1 Value Conversion Formulas	86
12.10.2 Frequency Capture Configuration	87
12.10.3 Frequency Capture Commands	88
12.11 ADC Unit	89
12.11.1 ADC Configuration	90
12.11.2 ADC Events	90
12.11.3 ADC Commands	91
12.12 DAC Unit	93
12.12.1 DAC Configuration	93
12.12.2 DAC Commands	93
12.13 PWM Unit	94

12.13.1 PWM Configuration	95
12.13.2 PWM Commands	95
12.14 Touch Sense Unit	95
12.14.1 Touch Sense Configuration	95
12.14.2 Touch Sense Events	96
12.14.3 Touch Sense Commands	96

**Part IV
Results**

13 Conclusion	101
----------------------	------------

Appendices

A Bibliography	105
-----------------------	------------

Figures

1.1 A collection of intelligent sensors and devices	3
2.1 A Discovery board with STM32F072	9
2.2 Form factor sketches	9
3.1 Raspberry Pi minicomputers	11
3.2 Bus Pirate v.4 (photo taken from [1])	12
3.3 Professional tools that GEX can replace	13
4.1 USB hierarchical structure	17
4.2 The logical structure of USB	18
4.3 USB descriptors of a GEX prototype obtained using “lsusb”	20
4.4 USB pull-ups	21
6.1 An example of the GEX virtual file system	32
7.1 UART frame format	35
7.2 SPI timing diagram	37
7.3 SPI master with multiple slaves	37
7.4 I ² C message diagram	38
7.5 1-Wire connection topology with four slave devices	39
7.6 A close-up photo of a WS2812B pixel, showing the LED driver IC	40
8.1 Direct frequency measurement method	44
8.2 Reciprocal frequency measurement method	44
8.3 Frequency measurement methods comparison	45
8.4 A diagram of the SAR type ADC	46
8.5 A simple implementation of the waveform generator	47
8.6 A block diagram of a DDS-based waveform generator	48
8.7 The touch slider on a STM32F072 Discovery board	49
8.8 A simplified schematic of the touch sensing circuit	49
8.9 TSC operation oscilloscope screenshots	50
9.1 Physical user interface of a GEX module	53

9.2 Block diagram showing the internal logic in the GEX firmware	55
9.3 The general structure of the source code repository	57
9.4 An example allocation in the resource registry	58
9.5 Structure of the settings subsystem	59
10.1 A diagram of the bulk read and write transaction.	66
11.1 Test setup with a GEX prototype controlling two nRF24L01+ modules	69
11.2 A block diagram of the wireless connection	72
12.1 Pin packing	76
12.2 SPI transaction using the QUERY command	81

Tables

- 6.1 Areas of a FAT-formatted disk 30
- 6.2 Structure of a FAT16 directory entry 31

- 7.1 NeoPixel pulse timing 41

- 11.1 Comparison of the SX1276 and nRF24L01+ wireless transceivers 71

Acronyms

AC alternating current	LED light emitting diode
ACM Abstract Control Model	LFN Long File Name
ADC Analog/Digital Converter	LIN Local Interconnect Network
API application programming interface	
BFSK binary frequency-shift keying	MBR master boot record
BOT Bulk Only Transport	M-Bus Meter Bus
	MCU microcontroller unit
CAN Controller Area Network	MISO Master In, Slave Out
CDC Communication Devices Class	MOSI Master Out, Slave In
CDC/ACM Communication Devices Class / Abstract Control Model	MSC Mass Storage Class
CRC cyclic redundancy check	MSK minimum-shift keying
CSB Chip Select Bar	
CTS Clear To Send	NCO numerically controlled oscillator
	NDIR nondispersive infrared
DAC Digital/Analog Converter	NFC near-field communication
DALI Digital Addressable Lighting Interface	NRZI Non Return to Zero Inverted
DC direct current	NSS Negated Slave Select
DDS Direct Digital Synthesis	NVIC Nested Vectored Interrupt Controller
DE Driver Enable	
DMA Direct Memory Access	OOK on-off keying
DTR Data Terminal Ready	OS operating system
FAT File Allocation Table	PC personal computer
FS file system	PCB printed circuit board
FSK frequency-shift keying	PMBus Power Management Bus
	PWM pulse width modulation
GFSK Gaussian frequency-shift keying	
GMSK Gaussian minimum-shift keying	RAM random-access memory
GND ground	ROM read-only memory
GPIO general purpose input/output	RTC real-time clock
GPS Global Positioning System	RTS Ready To Send
GSM Global System for Mobile communications	
GUI graphical user interface	SAR successive approximation register
	SCCB Serial Camera Control Bus
HART Highway Addressable Remote Transducer	SCK Serial Clock
	SCL Serial Clock Line
I²C Inter-Integrated Circuit	SCSI Small Computer System Interface
I²S Inter-IC Sound	SDA Serial Data Line
IAD Interface Association Descriptor	SMBus System Management Bus
IC integrated circuit	SPI Serial Peripheral Interconnect
IDE integrated desktop environment	SS Slave Select
	SSH Secure Shell
LCD liquid crystal display	STEM Science, Technology, Engineering and Mathematics
	TCO temperature-compensated oscillator
	TSC Touch Sensing Controller

TTL transistor-transistor logic

TVS transient-voltage suppressor

TWI Two-Wire Interface

UART Universal Asynchronous Receiver/Transmitter

USART Universal Synchronous/Asynchronous Receiver/Transmitter

USB Universal Serial Bus

VCO voltage-controlled oscillator



Part I

Introduction

Chapter 1

Motivation

Prototyping, design evaluation, and the measurement of physical properties in experiments make a daily occurrence in the engineering praxis. Those tasks often involve the generation and sampling of electrical signals coming to and from sensors, actuators, and other circuitry.

In the recent years, a wide range of intelligent sensors became available thanks to the drive for miniaturization in the consumer electronics industry. Those devices often provide a sufficient accuracy and precision while keeping the circuit complexity and cost low. In contrast to analog sensors, here the signal conditioning and processing circuits are built into the sensor itself and we access it using a digital connection.

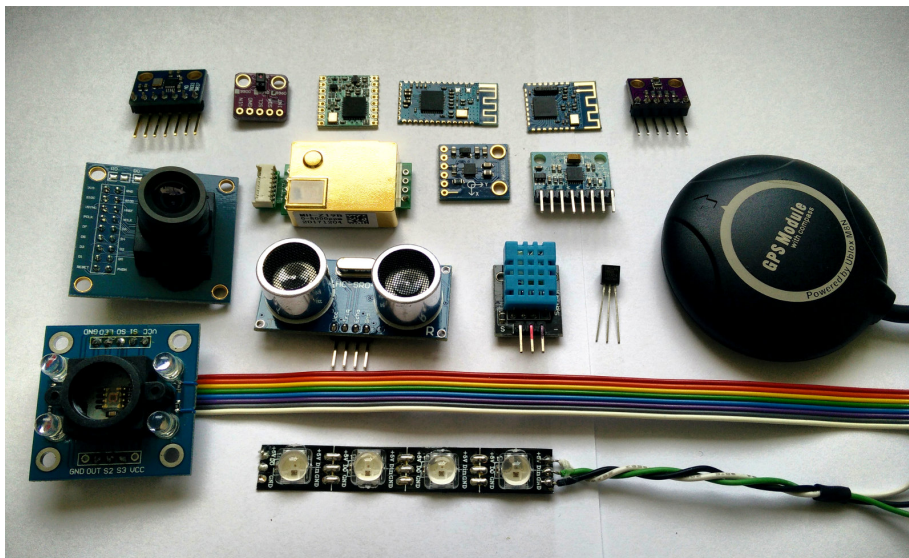

Figure 1.1: A collection of intelligent sensors and devices, most on breadboard adapters: (from top left) a waveform generator, a gesture detector, a LoRa and two Bluetooth modules, an air quality and pressure sensor, a CO₂ sensor, a digital compass, an accelerometer, a GPS module, a camera, an ultrasonic range finder, a humidity sensor, a 1-Wire thermometer, a color detector and an RGB LED strip.

To conduct experiments with those integrated modules, or even just familiarize ourselves with a device before using it in a project, we need a way to easily interact with them. It's also convenient to have a direct access to hardware, be it analog signal sampling, generation, or even just logic level inputs and outputs. However, the drive for miniaturization and

the advent of **Universal Serial Bus (USB)** lead to the disappearance of low level computer ports, such as the printer port (LPT), that would provide an easy way of doing so.

Today, when one wants to perform measurements using a digital sensor, the usual route is to implement an embedded firmware for a microcontroller that connects to the **personal computer (PC)** through **USB**, or perhaps just shows the results on a display. This approach has its advantages, but is time-consuming and requires knowledge entirely unrelated to the measurements we wish to perform. It would be advantageous to have a way to interface hardware without having to burden ourselves with the technicalities of the connection, even at the cost of lower performance compared to a specialized device or a professional tool.

The design and implementation of such a universal instrument is the object of this work. For technical reasons, such as naming the source code repositories, we need a name for the project; it'll be hereafter called *GEX*, a name originating from "GPIO Expander".

■ 1.1 The Project's Expected Outcome

It's been a desire of the author to create an universal instrument connecting low level hardware to a computer for many years, and with this project it is finally being realized. Several related projects approaching this problem from different angles can be found on the internet; those will be presented in chapter 3. This project should not end with yet another tinkering tool that will be produced in a few prototypes and then forgotten. By building an extensible, open-source platform, *GEX* can become the foundation for future projects which others can expand, re-use and adapt to their specific needs.

Building on the experience with earlier embedded projects, a **STM32** microcontroller shall be used. Those are **ARM Cortex M** devices with a wide range of hardware peripherals that appear be a good fit for the project. Low-cost evaluation boards are widely available that could be used as a hardware platform instead of developing a custom **printed circuit board (PCB)**. In addition, those chips are relatively cheap and popular in the embedded hardware community; there's a good possibility of the project building a community around it and growing beyond what will be presented in this paper.

Chapter 2

Requirement Analysis

We'll now investigate some situations where GEX could be used, to establish its requirements and desired features.

2.1 Desired Features

2.1.1 Interfacing Intelligent Modules

When adding a new digital sensor or a module to a hardware project, we want to test it first, learn how to properly communicate with it and confirm its performance. Based on this evaluation we decide whether the module matches our expectations and learn how to properly connect it, which is needed for a successful PCB layout.

In experimental setups, this may be the only thing we need. Data can readily be collected after just connecting the module to a PC, same as commanding motor controllers or other intelligent devices.

A couple well known hardware buses have established themselves as the standard ways to interface digital sensors and modules: **Serial Peripheral Interconnect (SPI)**, **Inter-Integrated Circuit (I²C)** and **Universal Synchronous/Asynchronous Receiver/Transmitter (USART)** (**UART** in asynchronous mode) are the most used ones, often accompanied by a few extra **general purpose input/output (GPIO)** lines for features such as Reset, Chip Enable, Interrupt. There are exceptions where silicon vendors have developed proprietary communication protocols that are still used, either for historical reasons or because of their specific advantages. An example is the 1-Wire protocol used by digital thermometers.

Moving to industrial and automotive environments, we can encounter various fieldbuses, Ethernet, **Controller Area Network (CAN)**, current loop, **Highway Addressable Remote Transducer (HART)**, **Local Interconnect Network (LIN)**, **Digital Addressable Lighting Interface (DALI)**, RS485 (e.g. for Modbus), **Meter Bus (M-Bus)**, PLC-BUS and others. Those typically use transceiver **integrated circuits (ICs)** and other circuitry, such as **transient-voltage suppressors (TVSs)**, discrete filters, galvanic isolation. They could be supported using add-on boards and additional firmware modules handling the protocol. For simplicity and to meet time constraints, the development of those boards and modules will be left for future expansions of the project.

■ 2.1.2 Analog Signal Acquisition

Sometimes it's necessary to use a traditional analog sensor, capture a transient waveform or to just measure a voltage. GEX was meant to focus on digital interfaces, however giving it this capability makes it much more versatile. Nearly all microcontrollers include an **Analog/Digital Converter (ADC)** which we can use to measure input voltages and, paired with a timer, to records signals varying in time.

Certain tasks, such as capturing transient effects on a thermocouple when inserted into a flame (an example from developing fire-proof materials) demand level triggering similar to that of oscilloscopes. The converter continuously measures the input voltage and a timed capture starts only after a set threshold is exceeded. This can be accompanied by a pre-trigger feature where the timed capture is continuously running and the last sample is always compared with the threshold, recording a portion of the historic records together with the following samples.

■ 2.1.3 Analog Signal Output

An analog signal can not only be measured, but it's often necessary to also generate it. This could serve as an excitation signal for an experiment, for instance to measure the characteristic curves of a diode or a transistor. Conveniently, we can at the same time use GEX's analog input to record the output.

Generating an analog signal is possible using a **pulse width modulation (PWM)** or by a dedicated digital-analog converter included in many microcontrollers. Higher frequencies or resolution can be achieved with a dedicated external **IC**.

■ 2.1.4 Logic Level Input and Output

We've covered some more advanced features, but skipped the simplest feature: a direct access to **GPIO** pins. Considering the latencies of **USB** and the **PC's** operating system, this can't be reliably used for "bit banging", however we can still accomplish a lot with just changing logic levels - e.g. to control character **liquid crystal displays (LCDs)**, or emulate some interfaces that include a clock line, like **SPI**. As mentioned in 2.1.1, many digital sensors and modules use plain **GPIOs** in addition to the communication bus for out-of-band signaling or features like chip selection or reset.

■ 2.1.5 Pulse Generation and Measurement

Some sensors have a variable frequency or a **PWM** output. To capture those signals and convert them to a more useful digital value, we can use the external input functions of a timer/counter in the microcontroller. Those timers have many possible configurations and can also be used for pulse counting or a pulse train generation.

2.2 Host Computer Connection

2.2.1 Communication Interface

USB shall be the primary way of connecting the module to a host **PC**. Thanks to **USB**'s flexibility, it can present itself as any kind of device or even multiple devices at once.

The most straightforward method of interfacing the board is by passing binary messages in a fashion similar to **UART**. We'll need a duplex connection to enable command confirmations, query-type commands and asynchronous event reporting. This is possible either using a "Virtual COM port" driver, or through a raw access to the corresponding **USB** endpoints. Using a raw access avoids potential problems with the operating system's driver interfering or not recognizing the device correctly; on the other hand, having GEX appear as a serial port makes it easier to integrate into existing platforms that have a good serial port support (such as National Instruments LabWindows CVI or MATLAB).

A connection using a hardware **UART** is also planned, as a fallback for boards without an **USB** connector or for platforms with no **USB** connectivity. A wireless connection to the host **PC** should also be possible and work transparently in a similar way to the **USB** or **UART** connection.

2.2.2 Configuration Files

The module must be easily reconfigurable. Given the settings are almost always going to be tied on the connected external hardware, it would be practical to have an option to store them permanently in the microcontroller's non-volatile memory.

We can load those settings into GEX using the serial interface, which also makes it possible to reconfigure it remotely when the wireless connection is used. With **USB**, we can additionally make the board appear as a mass storage device and expose the configuration as text files. This approach, inspired by ARM mbed's mechanism for flashing firmware images to development kits, avoids the need to create a configuration **graphical user interface (GUI)**, instead using the built-in applications of the **PC operating system (OS)**, like file explorer and notepad. We can expose additional information, such as a **README** file with instructions or a pin-out reference, as separate files on the virtual disk.

2.3 An Overview of Planned Features

Let's now summarize the features we wish to support in the GEX firmware, based on the preceding discussion:

- **Hardware interfacing functions**
 - I/O pin direct access (read, write), pin change interrupt
 - Analog input: voltage measurement, sampled capture
 - Analog output: static level, waveform generation

- Frequency, duty cycle, pulse length measurement
- Single pulse and PWM generation
- SPI, I²C, UART/USART
- Dallas 1-Wire
- NeoPixel (addressable light emitting diode (LED) strips)
- **Communication with the host computer**
 - USB connection as virtual serial port or direct endpoint access
 - Connection using plain UART
 - Wireless attachment
- **Configuration**
 - Fully reconfigurable, temporarily or permanently
 - Settings stored in INI files
 - File access through the communication application programming interface (API) or using a virtual mass storage

2.4 Microcontroller Selection

As discussed in section 1.1, this project will be based on microcontrollers from the STM32 family. The STM32F072 model was selected for the initial hardware and firmware design due to its low cost, advanced peripherals and the availability of development boards. The firmware can be ported to other microcontroller units (MCUs) later (e.g. to STM32L072, STM32F103 or STM32F303).

The STM32F072 is a Cortex M0 device with 128 KiB of flash memory, 16 KiB of random-access memory (RAM) and running at 48 MHz. It is equipped with a USB Full Speed peripheral block, a 12-bit ADC and Digital/Analog Converter (DAC), a number of general purpose timers/counters, SPI, I²C, and USART peripherals, among others. It supports crystal-less USB, using the USB SOF packet for synchronization of the internal 48 MHz RC oscillator; naturally, a real crystal resonator will provide better timing accuracy.

To effectively utilize the time available for this work, only the STM32F072 firmware will be developed while making sure the planned expansion is as straightforward as possible.

2.5 Form Factor Considerations

While the GEX firmware can be used with existing evaluation boards from ST Microelectronics (see figure 2.1 for an example of one such board), we wish to design and realize a few custom hardware prototypes that will be smaller and more convenient to use.

Three possible form factors are drawn in figure 2.2. The use of a common connector layout and pin assignments, here Arduino and Raspberry Pi, makes it possible to reuse

add-on boards from those platforms. When we copy the physical form factor of another product, in this example the Raspberry Pi Zero, we can further take advantage of existing enclosures designed for it.

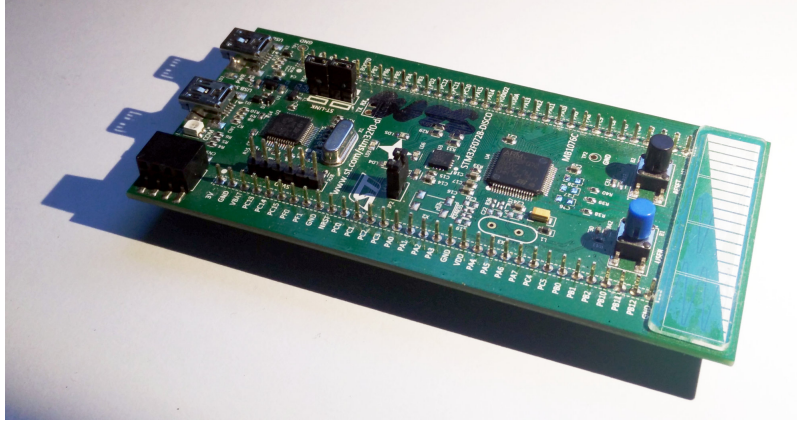

Figure 2.1: A Discovery development board with the STM32F072 microcontroller

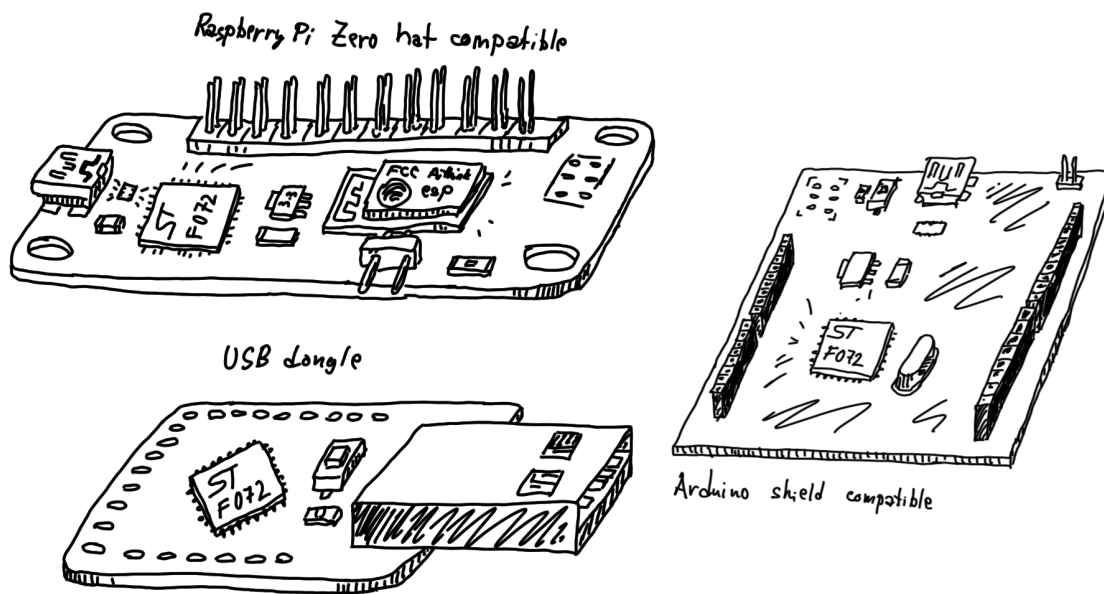

Figure 2.2: A sketch of three possible form factors for the GEX hardware prototype. Note the ESP8266 module which was considered as an option for wireless access but was eventually not used due to its high current usage, unsuitable for battery operation.

Chapter 3

Existing Solutions

The idea of making it easier to interact with low level hardware from a **PC** is not new. Several solutions to this problem have been developed, each with its own advantages and drawbacks. Some examples will be presented in this chapter.

3.1 Raspberry Pi

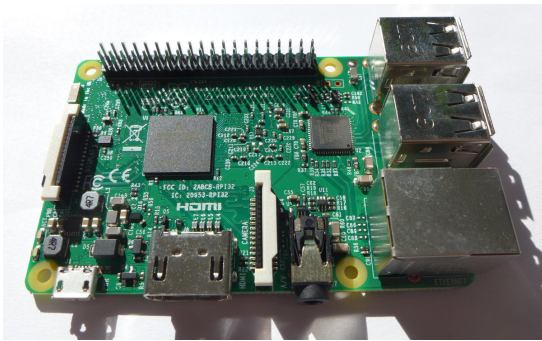

(a) : Raspberry Pi 3 Model B

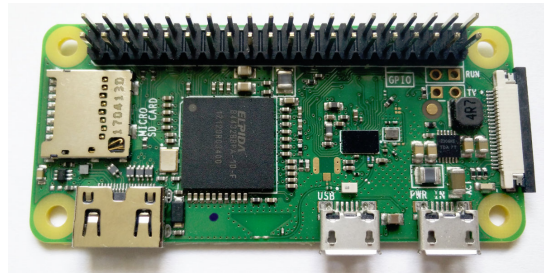

(b) : Raspberry Pi Zero W

Figure 3.1: Raspberry Pi minicomputers

The Raspberry Pi's **GPIO** header, a row of pins which can be directly controlled by user applications running on the minicomputer, was one of the inspirations behind GEX. It can be controlled using C and Python (among others) and offers **GPIO**, **SPI**, **I²C**, **UART** and **PWM**, with other protocols and functions easy to emulate thanks to the high speed of the system processor.

The Raspberry Pi is used in schools as a low-cost PC alternative that encourage students' interest in **Science, Technology, Engineering and Mathematics (STEM)**. The board is often built into more permanent projects that make use of its powerful processor, such as wildlife camera traps, fish feeders etc.

The Raspberry Pi could be used for the same quick evaluations or experiments we want to perform with GEX, however they would either have to be performed directly on the mini-computer, with an attached monitor and a keyboard, or use some form of remote access (e.g. **Secure Shell (SSH)**, screen sharing).

3.2 Bus Pirate

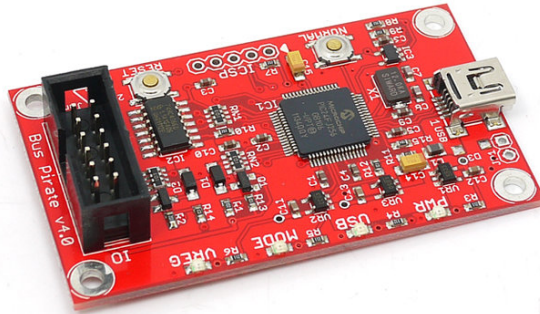

Figure 3.2: Bus Pirate v.4 (photo taken from [1])

Bus Pirate, a project by Ian Lesnet, is a USB-attached device providing access to hardware interfaces like **SPI**, **I²C**, **USART** and 1-Wire, as well as frequency measurement and direct pin access. The board aims to make it easy for users to familiarize themselves with new chips and modules; it also provides a range of programming interfaces for flashing microcontroller firmwares and memories. It communicates with the **PC** using a FTDI USB-serial bridge.

Bus Pirate is open source and is, in its scope, similar to GEX. It can be scripted and controlled from the PC, connects to USB and provides a wide selection of hardware interfaces.

The board is based on a PIC16 microcontroller running at 32 MHz. Its **ADC** only has a resolution of 10 bits (1024 levels). There is no **DAC** available on the chip, which makes applications that require a varied output voltage more difficult to implement. Another limitation of the board is its low number of **GPIO** pins, which may be insufficient for certain applications. The Bus Pirate is available for purchase at around 30 USD, a price comparable to some Raspberry Pi models.

3.3 Professional DAQ Modules

Various professional tools that would fulfill our needs exist on the market, but their high price makes them inaccessible for users with a limited budget, such as hobbyists or students who would like to keep such a device for personal use. An example is the National Instruments I²C/SPI Interface Device which also includes several **GPIO** lines, their USB DAQ module, or some of the Total Phase I²C/SPI gadgets (figure 3.3).

The performance GEX can provide may not always match that of those professional tools, but in many cases it'll be a sufficient substitute at a fraction of the cost.



(a) : NI I²C/SPI Interface Device

(b) : NI USB DAQ module



(c) : Total Phase SPI/I²C Host "Aardvark"

Figure 3.3: An example of professional tools that GEX could replace in less demanding scenarios (pictures taken from marketing materials: [2, 3, 4])



Part II

Theoretical Background

Chapter 4

Universal Serial Bus

This chapter presents an overview of the **Universal Serial Bus (USB)** Full Speed interface, with focus on the features used in the GEX firmware. **USB** is a versatile and powerful interface which replaces several older technologies; for this reason its specification is very complex and going into all details is hardly possible. We will cover the basic principles and terminology of **USB** and focus on the parts relevant for the GEX project. More information about the bus can be found in the official specification [5], related documents published by the USB Implementers Forum, and other on-line resources [6, 7].

4.1 Basic Principles and Terminology

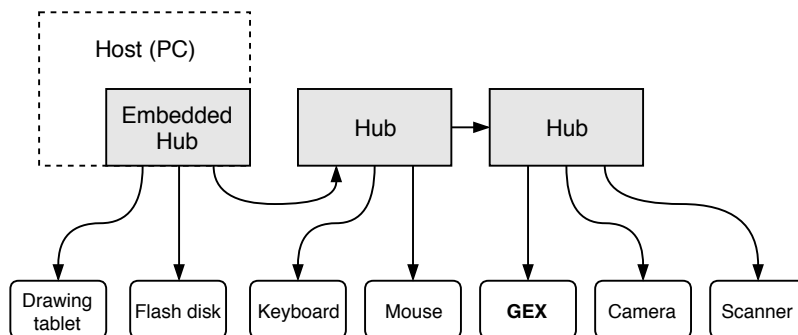

Figure 4.1: The hierarchical structure of the USB bus

USB is a hierarchical bus with a single master (*host*) and multiple slave devices. A **USB** device that provides functionality to the host is called a *function* [8].

4.1.1 Pipes and Endpoints

Communication between the host and a function is organized into virtual channels called *pipes* connecting to the device's *endpoints*, identified by endpoint numbers.

Endpoints can be either unidirectional or bidirectional; the direction from the host to a function is called **OUT**, the other direction (function to the host) is called **IN**. A bidirectional endpoint is technically composed of a **IN** and **OUT** endpoint with the same number. All transactions (both **IN** and **OUT**) are initiated by the host; functions have to wait for their turn. Endpoint 0 is bidirectional, always enabled, and serves as a *control endpoint*. The

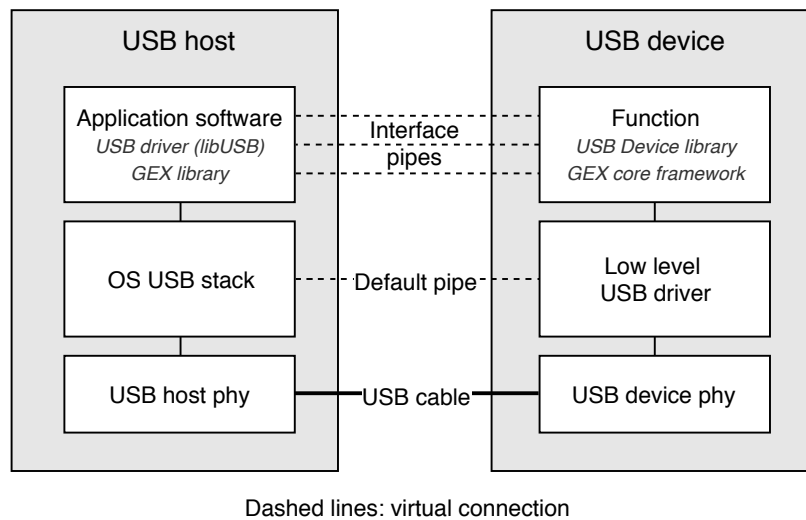

Figure 4.2: The logical structure of USB

host uses the control endpoint to read information about the device and configure it as needed.

■ 4.1.2 Transfer Types

There are four types of data transfers defined in **USB**: control, bulk, isochronous, and interrupt. Each endpoint is configured for a fixed transfer type:

- *Control* - initial configuration after device plug-in; also used for other application-specific control messages that can affect other pipes.
- *Bulk* - used for burst transfers of large messages, commonly e.g. for mass storage devices
- *Isochronous* - streaming with guaranteed low latency; designed for audio or video streams where some data loss is preferred over stuttering
- *Interrupt* - low latency short messages, used for human interface devices like mice and keyboards

■ 4.1.3 Interfaces and Classes

The function's endpoints are grouped into *interfaces*. An interface describes a logical connection of endpoints, such as the reception and transmission endpoints that belong together. An interface is assigned a *class* defining how it should be used.

Standard classes are defined by the USB specification [9] to provide a uniform way of interfacing devices of the same type, such as human-interface devices (mice, keyboards, gamepads) or mass storage devices. The use of standard classes makes it possible to re-use the same driver software for devices from different manufacturers.

The class used for the GEX's "virtual COM port" function was originally meant for telephone modems, a common way of connecting to the Internet at the time the first versions of USB were developed. A device using this class will show as `/dev/ttyACMO` on Linux and as a COM port on Windows, provided the system supports it natively or the right driver is installed.

■ 4.1.4 Descriptors

USB devices are introspectable, that is, the host can learn about a newly connected device automatically by probing it, without any user interaction. This is accomplished using a *descriptor table*, a binary structure stored in the function and read by the host through the control endpoint (default pipe) after the device is attached.

Each descriptor starts with a declaration of its length (in bytes), followed by its type, allowing the host to skip unknown descriptors without having to discard the rest of the table. The descriptors are logically nested and form a tree-like structure, but they are stored sequentially in the descriptor table and the lengths do not include sub-descriptors.

The topmost descriptor holds information about the entire function, including the vendor and product IDs which uniquely identifies the device model. It is followed by a Configuration descriptor, grouping a set of interfaces. More than one configuration may be present and available for the host to choose from; however, this is rarely used or needed. Each configuration descriptor is followed by one or more interface descriptors, each with its class-specific sub-descriptors and/or endpoint descriptors.

The descriptor table used by GEX is captured in figure 4.3 for illustration. The vendor and product IDs were obtained from the pid.codes repository [10] providing free product codes to open source projects. The official way of obtaining the unique code involves high recurring fees (\$4000 per annum) to the USB Implementers Forum, Inc. and is therefore not affordable for non-commercial use; alternatively, a product code may be obtained from some **MCU** vendors if their product is used in the device.

4. Universal Serial Bus

```

Device Descriptor:
  bLength                18
  bDescriptorType        1
  bcdUSB                  2.00
  bDeviceClass            239 Miscellaneous Device
  bDeviceSubClass         2
  bDeviceProtocol         1 Interface Association
  bMaxPacketSize0        64
  idVendor                0x1209 InterBiometrics
  idProduct              0x4c60
  bcdDevice               0.01
  iManufacturer          1 MightyPork
  iProduct                2 GEX
  iSerial                 3 0029002F-42365711-32353530
  bNumConfigurations     1
Configuration Descriptor:
  bLength                9
  bDescriptorType        2
  wTotalLength           98
  bNumInterfaces         3
  bConfigurationValue    1
  iConfiguration         0
  bmAttributes           0x80
    (Bus Powered)
  MaxPower               500mA
Interface Descriptor:
  bLength                9
  bDescriptorType        4
  bInterfaceNumber       0
  bAlternateSetting      0
  bNumEndpoints          2
  bInterfaceClass        8 Mass Storage
  bInterfaceSubClass     6 SCSI
  bInterfaceProtocol     80 Bulk-Only
  iInterface             4 Settings VFS
Endpoint Descriptor:
  bLength                7
  bDescriptorType        5
  bEndpointAddress      0x81 EP 1 IN
  bmAttributes           2
    Transfer Type        Bulk
    Synch Type           None
    Usage Type           Data
  wMaxPacketSize        0x0040 1x 64 bytes
  bInterval              0
Endpoint Descriptor:
  bLength                7
  bDescriptorType        5
  bEndpointAddress      0x01 EP 1 OUT
  bmAttributes           2
    Transfer Type        Bulk
    Synch Type           None
    Usage Type           Data
  wMaxPacketSize        0x0040 1x 64 bytes
  bInterval              0
Interface Association:
  bLength                8
  bDescriptorType        11
  bFirstInterface        1
  bInterfaceCount        2
  bFunctionClass         2 Communications
  bFunctionSubClass      2 Abstract (modem)
  bFunctionProtocol      1 AT-commands (v.25ter)
  iFunction               5 Virtual Comport ACM

Interface Descriptor:
  bLength                9
  bDescriptorType        4
  bInterfaceNumber       1
  bAlternateSetting      0
  bNumEndpoints          1
  bInterfaceClass        2 Communications
  bInterfaceSubClass     2 Abstract (modem)
  bInterfaceProtocol     1 AT-commands (v.25ter)
  iInterface             5 Virtual Comport ACM
CDC Header:
  bcdCDC                 1.10
CDC Call Management:
  bmCapabilities         0x00
  bDataInterface         2
CDC ACM:
  bmCapabilities         0x06
    sends break
    line coding and serial state
CDC Union:
  bMasterInterface       1
  bSlaveInterface        2
Endpoint Descriptor:
  bLength                7
  bDescriptorType        5
  bEndpointAddress      0x83 EP 3 IN
  bmAttributes           3
    Transfer Type        Interrupt
    Synch Type           None
    Usage Type           Data
  wMaxPacketSize        0x0008 1x 8 bytes
  bInterval              255
Interface Descriptor:
  bLength                9
  bDescriptorType        4
  bInterfaceNumber       2
  bAlternateSetting      0
  bNumEndpoints          2
  bInterfaceClass        10 CDC Data
  bInterfaceSubClass     0
  bInterfaceProtocol     0
  iInterface             6 Virtual Comport CDC
Endpoint Descriptor:
  bLength                7
  bDescriptorType        5
  bEndpointAddress      0x02 EP 2 OUT
  bmAttributes           2
    Transfer Type        Bulk
    Synch Type           None
    Usage Type           Data
  wMaxPacketSize        0x0040 1x 64 bytes
  bInterval              0
Endpoint Descriptor:
  bLength                7
  bDescriptorType        5
  bEndpointAddress      0x82 EP 2 IN
  bmAttributes           2
    Transfer Type        Bulk
    Synch Type           None
    Usage Type           Data
  wMaxPacketSize        0x0040 1x 64 bytes
  bInterval              0

```

Figure 4.3: USB descriptors of a GEX prototype obtained using “lsusb”

4.2 USB Physical Layer

USB uses differential signaling with **Non Return to Zero Inverted (NRZI)** encoding and bit stuffing (the insertion of dummy bits to prevent long intervals in the same **direct current (DC)** level). The encoding, together with frame formatting, checksum verification, retransmission, and other low level aspects of the USB connection are entirely handled by the USB physical interface block in the microcontroller's silicon. Normally we do not need to worry about those details; nonetheless, a curious reader may find more information in chapters 7 and 8 of [5]. What needs our attention are the electrical characteristics of the physical connection, which need to be understood correctly for a successful schematic and PCB design.

The USB cable contains 4 conductors: V_{BUS} (+5 V), D+, D-, and **ground (GND)**. The data lines, D+ and D-, are also commonly labeled DP and DM. This differential pair should be routed in parallel on the PCB and kept at the same length.

USB versions that share the same connector are backwards compatible. The desired bus speed is requested by the device using a 1.5 k Ω pull-up resistor to 3.3 V on one of the data lines: D+ pulled high for Full Speed (shown in figure 4.4), D- pulled high for Low Speed. The polarity of the differential signals is also inverted depending on the used speed, as the idle level changes. Some microcontrollers integrate the correct pull-up resistor inside the USB peripheral block (including out STM32F072), removing the need for an external resistor.

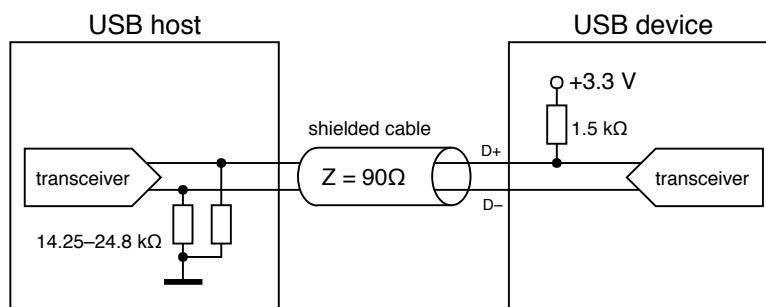

Figure 4.4: Pull-up and pull-down resistors near the host and a Full Speed function, as prescribed by the USB specification rev. 2.0

When a function needs to be re-enumerated by the host, which causes a reload of the descriptor table and the re-attachment of software drivers, it can momentarily remove the pull-up resistor, which the host will interpret as if the device was disconnected. With an internal pull-up, this can be done by flipping a bit in a control register. An external resistor may be connected through a transistor controlled by a GPIO pin. As discussed in [11], a GPIO pin might be used to drive the pull-up directly, though this has not been verified by the author.

The V_{BUS} line supplies power to *bus-powered* devices. *Self-powered* devices can leave this pin unconnected and instead use an external power supply. The maximal current drawn from the V_{BUS} line is configured using a descriptor and should not be exceeded, but experiments suggest this is often not enforced.

More details about the electrical and physical connection may be found in [6], sections *Connectors* through *Power*.

4.3 USB Classes

This section explains the classes used in the GEX firmware. A list of all standard classes with a more detailed explanation can be found in [9].

4.3.1 Mass Storage Class

The **Mass Storage Class (MSC)** is supported by all modern operating systems (MS Windows, MacOS, GNU/Linux, FreeBSD etc.) to support thumb drives, external disks, memory card readers and other storage devices.

The **MSC** specification [12] defines multiple *transport protocols* that can be selected using the descriptors. For it's simplicity, the **Bulk Only Transport (BOT)** [13] will be used. **BOT** uses two bulk endpoints for reading and writing blocks of data and for the exchange of control commands and status messages.

For the mass storage device to be recognized by the host operating system, it must also implement a *command set*. Most mass storage devices use the *Small Computer System Interface (SCSI) Transparent command set*¹.

Unfortunately, the **SCSI** Transparent command set appears to have been deliberately left unspecified for license or copyright reasons (see discussion in [14] and the surrounding thread) and the protocol now used under this name is an industry standard without a clear definition. Some pointers may be found in [15] and by examining the source code of the USB Device driver library provided by ST Microelectronics.

This command set lets the host read information about the attached storage, such as its capacity, and check for media presence and readiness to write or detach. This is used e.g. for the “Safely Remove” function, which ensures that all internal buffers have been written to Flash.

In order to emulate a mass storage device without having a physical storage medium, we need to generate and parse the file system on-the-fly as the host **OS** tries to access it. This will be discussed in chapter 6.

4.3.2 CDC/ACM Class

Historically meant for modem communication, **Communication Devices Class / Abstract Control Model (CDC/ACM)** is now the de facto standard way of making **USB** devices appear as serial ports on the host **OS**. Its specification can be found in [16]. **CDC/ACM** is a combination of two related classes, **CDC** handling the data communication and **ACM**,

¹To confirm this assertion, the descriptors of five thumb drives and an external hard disk were analyzed using `lsusb`. All but one device used the **SCSI** command set, one (the oldest thumb drive) used *SFF-8070i*. A list of possible command sets can be found in [12]

which defines control commands. Three endpoints are used: bulk IN, bulk OUT, and interrupt OUT.

The interrupt endpoint is used for control commands, such as toggling the auxiliary lines of RS-232 or setting the baud rate. Since GEX does not translate the data communication to any physical UART, those commands are not applicable and can be silently ignored.

An interesting property of the **CDC** class is that the bulk endpoints transport raw data without any wrapping frames. By changing the interface's class in the descriptor table to 255 (*Vendor Specific Class*), we can retain the messaging functionality of the designated endpoints, while accessing the endpoints device directly using e.g. libUSB, without any interference from the **OS**. This approach is also used to hide the **MSC** interface when its not needed.

4.3.3 Interface Association: Composite Class

Since its creation, the **USB** specification expected that each function will have only one interface enabled at a time. After it became apparent that there is a need for having multiple unrelated interfaces work in parallel, the **Interface Association Descriptor (IAD)** [17] was introduced as a workaround.

The **IAD** is an entry in the descriptor table that defines which interfaces belong together and should be handled by the same software driver. To use the **IAD**, the function's class must be set to 239 (0xEF), subclass 2 and protocol 1 in the top level descriptor, so that the **OS** knows to look for this descriptor before binding drivers to any interfaces.

In GEX, the **IAD** is used to tie together the **CDC** and **ACM** interfaces while leaving out the **MSC** interface which should be handled by a different driver. To make this work, a new *composite class* had to be created as a wrapper for the library-provided **MSC** and **CDC/ACM** implementation.

Chapter 5

FreeRTOS

FreeRTOS is a free, open-source real time operating system kernel targeted at embedded systems and ported to many different microcontroller architectures [18]. FreeRTOS provides the task scheduler, forming the central part of the RTOS, and implements queues, semaphores, and mutexes for message passing and synchronization between concurrent tasks (summarily called synchronization objects¹). FreeRTOS is compact and designed to be easy to understand; it's written in C, with the exception of some architecture-specific routines which use assembly. A complete overview of the system is available in the FreeRTOS reference manual [19] and its guide book [20].

FreeRTOS is used in GEX for its synchronization objects that make it easy to safely pass messages between interrupts and working threads, without deadlocks or race conditions. The built-in stack overflow protection helps with a more efficient memory allocation, and the heap allocator provided by FreeRTOS enables a thread-safe dynamic allocation with a shared heap.

5.1 Basic FreeRTOS Concepts and Functions

5.1.1 Tasks

Threads in FreeRTOS are called *tasks*. Each task is assigned a memory area to use as its stack space, and a holding structure with its name, saved *context*, and other metadata used by the kernel. A task context includes the program counter, stack pointer and other register values. Task switching is done by saving and restoring this context by manipulating the values on the stack before leaving and interrupt. The FreeRTOS website provides an example with the AVR port [21] demonstrating how its internal functionality is implemented, including the context switch.

At start-up the firmware initializes the kernel, registers tasks to run and starts the scheduler. From this point onward the scheduler is in control and runs the tasks using a round robin scheme, always giving a task one tick of run time (usually 1 ms) before interrupting it. Which task should run is primarily determined by their priority numbers, but there are other factors.

¹In this chapter sometimes simply called “objects”.

- **Counting semaphores** are used to represent available resources. A pool of software or hardware resources is accompanied by a counting semaphore, so that tasks can wait for a resource to become available in the pool and then subtract the semaphore value. After finishing with a resource, the semaphore is incremented again and another task can use it.
- **Mutexes** (locks), unlike semaphores, must be taken and released in the same thread (task). They're used to guard exclusive access to a resource, such as writing to a serial port, or accessing a shared memory. When a mutex is taken, a different task which needs to use it enters the Blocked state and is resumed once the mutex becomes available (at which point the task is resumed and simultaneously takes it).
- **Queues** are used for passing messages between tasks, or from interrupts to tasks. Both sending and receiving of queue messages can block the task until the operation becomes possible. A queue handling task is often simply a loop which tries to read from the queue with an infinite timeout and processes the received data once the reading succeeds.

It must be noted that synchronization objects like mutexes and semaphores can help combat concurrent access only when used consistently and correctly. A locked mutex can't guard against a rogue task accessing the protected resource without checking.

5.2 Stack Overflow Protection

Each task in FreeRTOS is assigned a block of **RAM** to use as its stack when it runs. This is where the stack pointer is restored to in the context switch. It can happen that an insufficient stack is exceeded and the stack pointer moves outside the designated area. Without countermeasures this would mean that we are overwriting bytes in some unrelated memory structure, perhaps another task's control block or a stack.

A stack overflow protection can be enabled by a flag in the FreeRTOS configuration file (more details in [22]). This function works in two ways: the more obvious is a simple check that the stack pointer remains in the designated area; however, as the check may be performed only in the scheduler interrupt, it can happen that the stack pointer exceeds the bounds only temporarily and returns back before the stack can be checked for overflow. The stack is thus filled with a known filler value before starting the task, and the last few bytes are then tested to match this value. Not only can we detect a stack overflow more reliably, this feature also makes it possible to estimate the peak stack usage by counting the remaining filler values in the stack area. Naturally, we can't distinguish between the original filler values and the same value stored on the stack; still, this method proves remarkably successful in the detection of misconfigured stack size.

Chapter 6

The FAT16 File System and Its Emulation

A **file system (FS)** is used by GEX to provide a comfortable access to the configuration files. By emulating a Mass Storage **USB** device, the module appears as a thumb drive on the host **PC**, and the user can edit its configuration using their preferred text editor. The FAT16 file system was selected for its simplicity and a good cross-platform support [23].

Three variants of the **File Allocation Table (FAT)** file system exist: FAT12, FAT16, and FAT32. FAT12 was used on floppy disks and it is similar to FAT16, except for additional size constraints and a **FAT** entry packing scheme. FAT16 and FAT32 are FAT12's later developments from the time when hard disks became more common and the old addressing scheme couldn't support their larger capacity.

This chapter will explain the structure of FAT16 and the challenges faced when trying to emulate it without a physical data storage.

6.1 The General Structure of the FAT File System

An overview will be presented here without going into too many details that would overwhelm the reader and can be looked up elsewhere. Several resources [24, 25, 26, 27, 28] were consulted during the development of the GEX firmware which provide a more complete description of the FAT16 file system, with [28], the Microsoft white paper, giving the most detailed overview.

The storage medium is organized into *sectors* (or *blocks*), usually 512 bytes long. Those are the smallest addressing unit in the disk structure. The disk starts with a *boot sector*, also called a **master boot record (MBR)**. That is followed by optional reserved sectors, one or two copies of the file allocation table, and the root directory. All disk areas are aligned to a sector boundary:

6.1.1 Boot Sector

This is a 1-sector structure which holds the **OS** bootstrap code for bootable disks. The first 3 bytes are a jump instruction to the actual bootstrap code located later in the sector. What matters to us when implementing the file system is that the boot sector also contains data fields describing how the disk is organized, what file system is used, who formatted it, etc. The size of the **FAT** and the root directory is defined here. The exact structure of the

Disk area	Size / Notes
Boot sector	1 sector
Reserved sectors	optional
FAT 1	1 or more sectors, depends on disk size
FAT 2	optional, a back-up copy of FAT 1
Root directory	1 or more sectors
Data area	Organized in <i>clusters</i>

Table 6.1: Areas of a FAT-formatted disk

boot sector can be found in either of [24, 25, 26, 27, 28] or in the attached GEX source code.

6.1.2 File Allocation Table

The data area of the disk is organized in clusters, logical allocation units composed of groups of sectors. The use of a larger allocation unit allows the system to use shorter addresses and thus support a larger disk capacity.

The **FAT** acts as a look-up table combined with linked lists. In FAT16, it is organized in 16-bit fields, each corresponding to one cluster. The first two entries in the allocation table are reserved and hold special values set by the disk formatter and the host **OS**: a “media descriptor” 0xFFFF8 and a “clean/dirty flag” 0xFFFF/0x3FFF.

Files can span multiple clusters; each **FAT** entry either holds the address of the following file cluster, or a special value:

- 0x0000 - free cluster
- 0xFFFF - last cluster of the file (still including file data)
- 0xFFF7 - bad cluster

The bad cluster mark, 0xFFF7, is used for clusters which are known to corrupt data due to a flaw in the storage medium, such as a bad memory cell.

6.1.3 Root Directory

The root directory has the same structure as any other directories, which reside in clusters the same way like ordinary files. The difference is that the root directory is allocated when the disk is formatted and it has a fixed and known position and size. Sub-directories are stored on the disk in a way similar to regular files, therefore they can span multiple sectors and their file count can be much larger than that of the root directory.

A directory is organized in 32-byte entries representing individual files. Table 6.2 shows the structure of one such entry. The name and extension fields form together the well-known 8.3 filename format (referring to the byte size of the first two entries). Longer file names

Offset	Size (bytes)	Description
0	8	File name (padded with spaces)
8	3	File extension
11	1	File attributes
12	10	Reserved
22	2	Creation time
24	2	Creation date
26	2	Address of the first cluster
28	4	File size (bytes)

Table 6.2: Structure of a FAT16 directory entry

are encoded using a **Long File Name (LFN)** scheme [29] as special hidden entries stored in the directory table alongside the regular 8.3 entries, ensuring backward compatibility.

The first byte of the file name has a special meaning:

- 0x00 - indicates that there are no more files when searching the directory
- 0xE5 - marks a free slot; this is used when a file is deleted
- 0x05 - indicates that the first byte should actually be 0xE5, a code used in some character sets at the time, and the slot is *not* free¹.
- Any other value, except 0x20 (space) and characters forbidden in a DOS file name, starts a valid file entry. Generally, only space, A-Z, 0-9, - and _ should be used in file names for maximum compatibility.

The attributes field contains flags such as *directory*, *volume label*, *read-only* and *hidden*. Volume label is a special entry in the root directory, which defines the disk's label shown on the host PC. A file with the directory bit set is actually a pointer to a subdirectory, meaning that when we open the linked cluster, we'll find a new directory table.

Figure 6.1 shows a possible organization of the GEX file system with two INI files, one spanning two clusters, the other being entirely inside one. The clusters need not be used completely; an exact file size is stored in the directory entries.

6.2 FAT16 Emulation

The FAT16 file system is relatively straightforward to implement. However, it is not practical or even possible to keep the entire file system in memory on a small microcontroller like

¹The special meaning of 0xE5 appears to be a correction of a less than ideal design choice earlier in the development of the file system

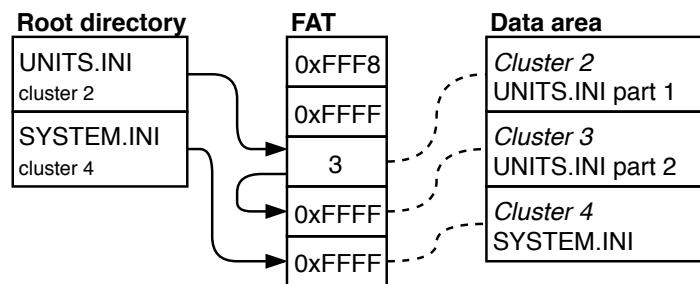

Figure 6.1: An example of the GEX virtual file system

our STM32F072. This means that we have to generate and parse disk sectors and clusters on-demand, when the host reads or writes them. The STM32 [USB Device](#) library helpfully implements the [MSC](#) and provides [API](#) endpoints to which we connect our file system emulator. Specifically, those are requests to read and write a sector, and to read disk status and parameters, such as its size.

6.2.1 DAPLink Emulator

A FAT16 emulator was developed as part of the open-source Arm Mbed DAPLink project [30]. It is used there for a drag-and-drop flashing of firmware images to the target microcontroller, taking advantage of the inherent cross-platform support (it uses the same software driver as any thumb drive, as discussed in 4.3.1). Arm Mbed also uses a browser-based [integrated desktop environment \(IDE\)](#) and cloud build servers, thus the end user does not need to install or set up any software to program a compatible development kit.

The GEX firmware adapts several parts of the DAPLink code, optimizing its [RAM](#) usage and porting it to work with FreeRTOS. Those modified files are located in the folder `User/vfs` of the GEX source code repository; the original Apache 2.0 open source software license headers, as well as file names, have been retained.

6.2.2 Handling a Read Access

As shown in table 6.1, the disk consists of several areas. The boot sector is immutable and can be stored in and read from the Flash memory. The handling of the other disk areas ([FAT](#), data area) depends on the type of access: read or write.

The user can only read files that already exist on the disk, in our case, `UNITS.INI` and `SYSTEM.INI`. Those files are generated from the binary settings storage, and conversely, parsed, line-by-line, without ever existing in their full form. This fact makes our task more challenging, as the files can't be easily measured and there's no obvious way to read a sector from the middle of a longer file. We solve this by implementing two additional functions in the INI file writer: a *read window* and a *dummy read mode*.

A read window is a byte range which we wish to generate. The INI writer discards bytes before the start of the read window, writes those inside the window to our data buffer, and stops when its end is reached. This lets us extract a sector from anywhere in a file.

The second function, dummy read, is tied to the window function: we set the start index so high that it's never reached (e.g. 0xFFFFFFFF), and have the writer count discarded characters. When the dummy file generation ends, this character counter holds its size.

Now, just one problem remains: how to tell which sectors contain which part of our files? This is straightforward when we realize that the files change only when the user modifies the settings. After each such change, an algorithm is run which allocates clusters to the files and preserves this information in a holding structure. A subsequent read access simply requires a look into this structure and the corresponding chunk of a file may be served using the read window function. The **FAT** can be dynamically generated from this information as well.

■ 6.2.3 Handling a Write Access

A write access to the disk is more challenging to emulate than a read access, as the host OS tends to be somewhat unpredictable. In GEX's case we are interested only in the action of overwriting an already existing file, but it is interesting to also analyze other actions the host may perform.

It must be noted that due to the nonexistence of a physical storage medium, it's not possible to read back a file the host has previously written, unless we store or re-generate its content when such a read access occurs. The **OS** may show the written file on the disk, but when the user tried to read it, the action either fails, or shows a cached copy. The emulator would work around this problem by temporarily reporting that the storage medium has been removed, forcing the host to re-load its contents.

■ File Deletion

A file is deleted by:

1. Marking all sectors used by it as free in the **FAT**
2. Replacing the first character of its name in the directory table by 0xE5 to indicate the slot is free

From the perspective of emulation, we can ignore the **FAT** access and only detect writes to the directory sectors. This is slightly more complicated when one considers that all disk access is performed in sectors: the emulator must compare the written data with the original bytes to detect what change has been performed. Alternatively, we could parse the entire written sector as a directory table and compare it with our knowledge of its original contents.

■ 6.2.4 File Name Change

A file is renamed by modifying its directory entry. In the simple case of a short, 8.3 file name, this is an in-place modification of the file entry. Long file names, using the **LFN** extension, are a complication, as the number of non-file entries holding the long file name might change, and subsequently the following entries in the table may shift or be re-arranged.

■ 6.2.5 File Creation

A new file is created in three steps:

1. Finding free clusters and chaining them by writing the following cluster addresses (or 0xFFFF for the last cluster) into the **FAT**
2. Finding and overwriting a free entry in the directory table
3. Writing the file content

It can be expected the host **OS** first finds the free sectors and a free file entry before performing any write operations, to prevent a potential disk corruption.

To properly handle such a file by the emulator, we could, in theory, find its name from the directory table, which has been updated, and then collect the data written to the corresponding clusters. In practice, confirmed by experiments with a real Linux host, those three steps may happen in any order, and often the content is written before the directory table is updated.

The uncertain order of the written disk areas poses a problem when the file name has any significance, as we can't store the received file data while waiting for the name to be written. The DAPLink mbed flashing firmware solves this by analyzing the content of the first written sector of the file, which may contain the binary **Nested Vectored Interrupt Controller (NVIC)** table, or a character pattern typical for Intel hex files.

■ 6.2.6 File Content Change

A change to a file's content is performed in a similar way to the creation of a new file, except instead of creating a new entry in the directory table, an existing one is updated with the new file size. The name of the file may be unknown until the content is written, but we could detect the file name by comparing the start sector with those of all files known to the virtual file system.

In the case of GEX, the detection of a file name is not important; we expect only INI files to be written, and the particular file may be detected by its first section marker, such as [UNITS] or [SYSTEM]. Should a non-INI file be written by accident, the INI parser will likely detect a syntax error and discard it.

It should be noted that a file could be updated only partially, skipping the clusters which remain unchanged, and there is also no guarantee regarding the order in which the file's sectors are written. This is hard to detect and handle correctly, but it can be detected by the emulator and such a write operation will be discarded. Fortunately, this host behavior has not been conclusively observed in practice, but the writing of a file rarely fails for unknown reasons; this could be a possible cause.

Chapter 7

Supported Hardware Buses

Hardware buses implemented in GEX are presented in this chapter. The description of each bus is accompanied by several examples of devices that can be interfaced with it. The reader is advised to consult the official specifications and particular devices' datasheets for additional details.

7.1 UART and USART

The **Universal Synchronous/Asynchronous Receiver/Transmitter (USART)** has a long history and is still in widespread use today. It is the protocol used in RS-232, which was once a common way of connecting modems, printers, mice and other devices to personal computers. RS-232 can be considered the ancestor of **USB** in its widespread availability and use. **UART** framing is also used in the industrial bus RS-485 and the automotive interconnect bus **LIN**.

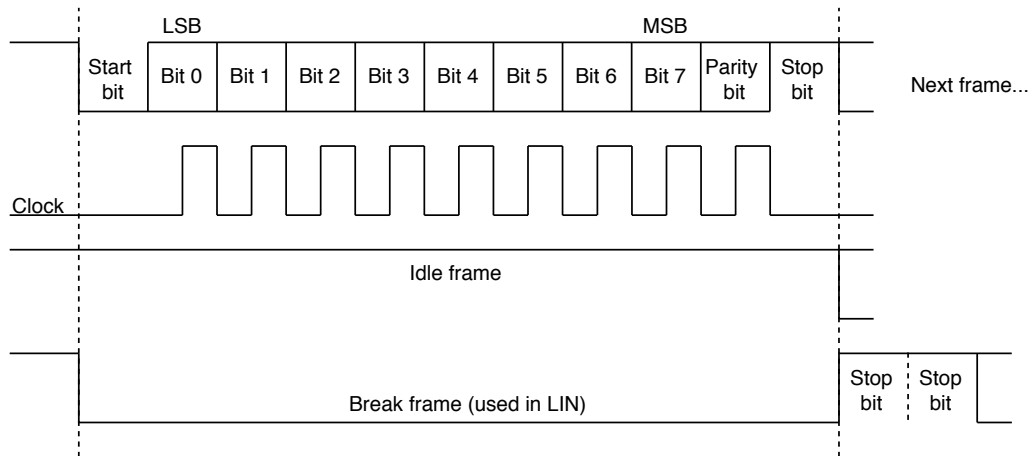

Figure 7.1: USART frame format in the 8-bit configuration with parity

UART and **USART** are two variants of the same interface. **USART** includes a separate clock signal, while the **UART** timing relies on a well-known clock speed and the bit clock is synchronized by start bits. **USART** was historically used in modems to achieve higher bandwidth, but is now mostly obsolete.

USART, as implemented by microcontrollers such as the STM32 family, is a two-wire full duplex interface that uses 3.3 V or 5 V logic levels. The data lines are in the high logical

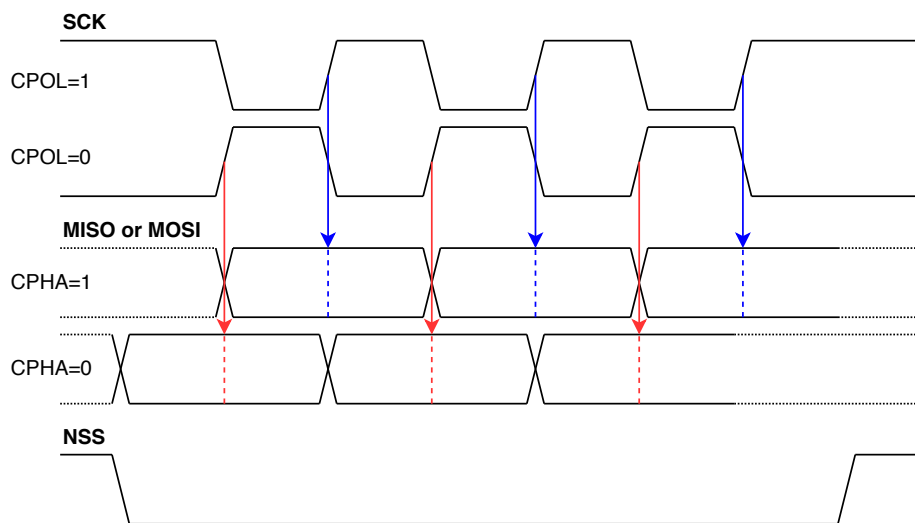

Figure 7.2: SPI timing diagram explaining the CPOL and CPHA settings (shown on 3 data bits; a real message will use at least 8 bits)

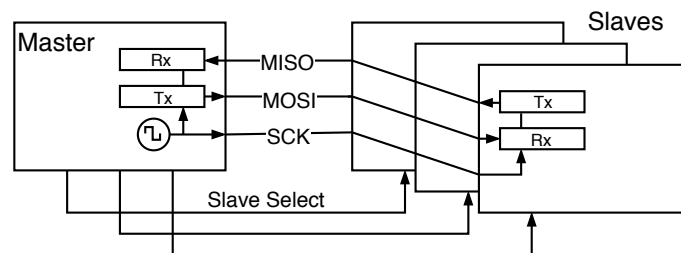

Figure 7.3: A SPI bus with 1 master and 3 slaves, each enabled by its own Slave Select signal

7.2.1 Examples of Devices Using SPI

- **SX1276** - LoRa transceiver
- **nRF24L01+** - 2.4 GHz ISM band radio module
- **L3GD20** - 3-axis gyroscope
- **BMP280** - pressure sensor
- **BME680** - air quality sensor
- **ENC28J60** - Ethernet controller
- **L6470** - intelligent stepper motor driver
- **AD9833** - waveform generator (**MOSI** only)
- **ADE7912** - triple Σ - Δ **ADC** for power metering applications
- **SD cards** [32]
- SPI-interfaced EEPROM and Flash memories

7.3 I²C

Inter-Integrated Circuit (I²C) is a two-wire, open-drain bus that supports multi-master operation. It uses two connections (plus GND): **Serial Data Line (SDA)** and **Serial Clock Line (SCL)**, both open-drain with a pull-up resistor.

The protocol was developed by Philips Semiconductor (now NXP Semiconductors) and its implementors were required to pay licensing fees, until 2006, leading to the development of compatible implementations with different names, such as Atmel’s **Two-Wire Interface (TWI)** or Dallas Semiconductor’s “Serial 2-wire Interface” (e.g. used in the DS1307 **real-time clock (RTC)** chip). I²C is a basis of the **System Management Bus (SMBus)** and **Power Management Bus (PMBus)**, which add additional constraints and rules for a more robust operation.

The frame format is shown and explained in figure 7.4; more details may be found in the specification [33] or application notes and datasheets offered by chip vendors, such as the white paper from Texas Instruments [34]. A frame starts with a start condition and stops with a stop condition, defined by an SDA edge while the SCL is high. The address and data bytes are acknowledged by the slave by sending a 0 on the open-drain SDA line in the following clock cycle. A slave can terminate the transaction by sending 1 in place of the acknowledge bit. Slow slave devices may stop the master from sending more data by holding the SCL line low at the end of a byte, a feature called *Clock Stretching*. As the bus is open-drain, the line can’t go high until all participants release it.

Two addressing modes are defined: 7-bit and 10-bit. Due to the small address space, exacerbated by many devices implementing only the 7-bit addressing, collisions between different chips on a shared bus are common; many devices thus offer several pins to let the board designer choose a few bits of the address by connecting them to different logic levels.

The bus supports multi-master operation, which leads to the problem of collisions. Multi-master capable devices must implement a bus arbitration scheme as specified by the I²C standard [33]. This feature is not used often in intelligent sensors and modules; the most common topology is multi-drop single-master, similar to SPI, with the advantage of using only two pins on the microcontroller.

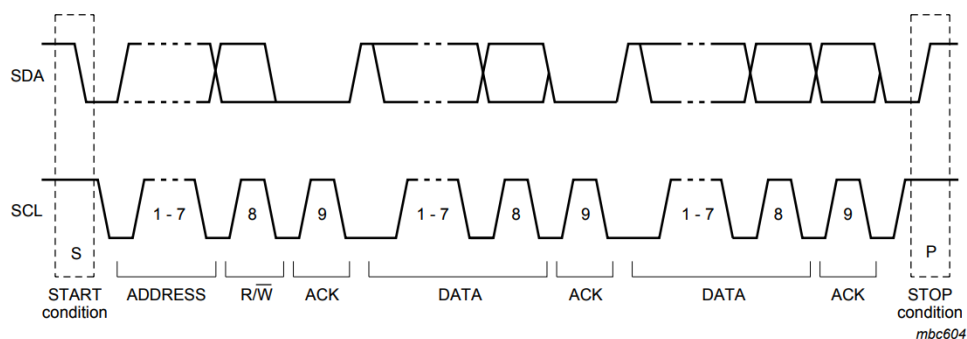

Figure 7.4: An I²C message diagram (taken from the I²C specification [33])

7.3.1 Examples of Devices Using I²C

- **APDS-9960** - ambient light, proximity and gesture sensor
- **L3GD20, BMP280, BME680** - listed as **SPI** devices, those also support **I²C**
- **DS1307** - **RTC**; **I²C** is not mentioned in the entire datasheet, presumably to avoid paying license fees, but it is fully compatible
- **IS31FL3730** - a **LED** matrix driver
- The **Serial Camera Control Bus (SCCB)** used to configure camera modules is derived from **I²C**

7.4 1-Wire

The 1-Wire bus, developed by Dallas Semiconductor (acquired by Maxim Integrated), uses a single, bi-directional data line, which can also power the slave devices in a *parasitic mode*, reducing the number of required wires to just two (compare with 3 in **I²C** and 5 in **SPI**, all including **GND**). The parasitic operation is possible thanks to the data line resting at a logic high level most of the time, charging an internal capacitor.

1-Wire uses an open-drain connection for the data line, similar to **I²C**, though the protocol demands it to be connected directly to V_{dd} in some places when the parasitic mode is used; this is accomplished using an external transistor, or by reconfiguring the GPIO pin as output and setting it to 1, provided the microcontroller is able to supply a sufficient current.

The communication consists of short pulses sent by the master and (for bit reading) the line continuing to be held low by the slave for a defined amount of time. The pulse timing determines whether it is a read or write operation and which value is encoded. It can be implemented either in software as delay loops, or by abusing **UART** peripheral, as explained in [35]. Detailed timing diagrams can be found in the DS18x20 [36]. 1-Wire transactions include a checksum byte to ensure an error-free communication.

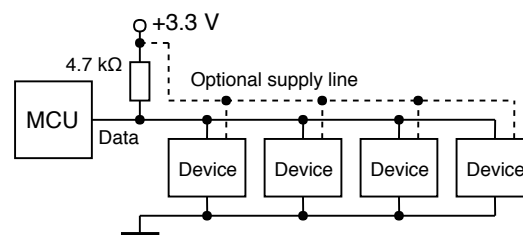

Figure 7.5: 1-Wire connection topology with four slave devices

Devices are addressed by their unique 64-bit ID numbers called ROM codes or ROMs; they can be found by the bus master, with a cooperation from slaves, using a ROM Search algorithm. The search algorithm is explained in [37], including a possible implementation example. If only one device is connected, a wild card command Skip ROM can be used to address the device without a known ROM code.

7.4.1 Examples of Devices Using 1-Wire

- **DS1820**, **DS18S20**, **DS18B20** - digital thermometers
- **iButton** - contact-read access tokens, temperature loggers, etc.

Since 1-Wire is a proprietary protocol, there is a much smaller choice of available devices and they also tend to be more expensive. The DS18x20 thermometers are, however, popular enough to warrant the bus's inclusion in GEX.

7.5 NeoPixel

NeoPixel is a marketing name of the **WS2812** and compatible intelligent **LED** drivers that are commonly used in “addressable **LED** strips”. Details about the protocol may be found in the WS2812B datasheet [38]. Those chips include the control logic, PWM drivers and the **LED** diodes all in one 5×5 mm SMD package.

The NeoPixel protocol is unidirectional, using only one data pin. The **LED** drivers are chained together. Ones and zeros are encoded by pulses of a defined length on the data pin; after the color data was loaded into the **LED** string, a longer "reset" pulse (low level) is issued by the bus master and the set colors are displayed. The timing constraints are listed in table 7.1.

The NeoPixel timing is sensitive to pulse length accuracy; a deviation from the specified timing may cause the data to be misinterpreted by the drivers. Some ways to implement the timing use hardware timers or the **Inter-IC Sound (I²S)** peripheral. An easier method that does not require any additional hardware resources beyond the **GPIO** pin is to implement the timing using delay loops in the firmware; care must be taken to disable interrupts in the sensitive parts of the timing; it may be advantageous to implement it in assembly for a tighter control.

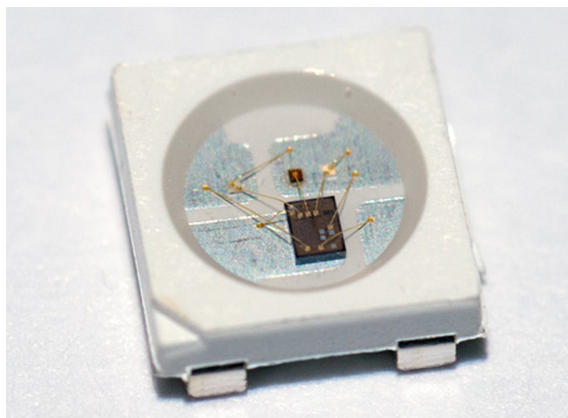

Figure 7.6: A close-up photo of a WS2812B pixel, showing the LED driver IC

Bit value	Constraint	Duration
0	High level	$0.4 \mu\text{s} \pm 150\text{ns}$
0	Low level	$0.85 \mu\text{s} \pm 150\text{ns}$
1	High level	$0.45 \mu\text{s} \pm 150\text{ns}$
1	Low level	$0.8 \mu\text{s} \pm 150\text{ns}$
–	Reset pulse (low)	$> 50 \mu\text{s}$

Table 7.1: NeoPixel pulse timing

Chapter 8

Non-communication Hardware Functions

In addition to communication buses, described in chapter 7, GEX implements several measurement and output functions that take advantage of the microcontroller's peripheral blocks, such as timers/counters and DAC. The more complicated ones are described here; simpler functions, such as the raw GPIO access, will be described later together with their control API.

8.1 Frequency Measurement

Applications like motor speed measurement and the reading of a voltage-controlled oscillator (VCO) or VCO-based sensor's output demand a tool capable of measuring frequency. This can be done using a laboratory instrument such as the Agilent 53131A. A low cost solution is to use a timer/counter peripheral of a microcontroller.

Two basic methods to measure frequency exist [39], each with its advantages and drawbacks:

- The *direct method* (fig. 8.1) is based on the definition of frequency as a number of cycles n in a fixed-length time window τ (usually 1 s); the frequency is then calculated as $f = n/\tau$.

One timer generates the time window and its output gates the input of another, configured as a pulse counter. At the end of the measurement window an interrupt is generated and we can read the pulse count from the counter's register.

The direct method has a resolution of 1 Hz with a sampling window of 1 s (only a whole number of pulses can be counted). The resolution can be increased by using a longer time window, provided the measured signal is stable enough to make averaging possible without distorting the result. Further increase of precision is possible through analog or digital interpolation [40], a method used in some professional equipment.

- The *indirect* or *reciprocal method* (fig. 8.2) measures one period T as the time interval between two pulses and this is then converted to frequency as $f = 1/T$.

This method needs only one timer/counter. Cycles of the system clock are counted for the duration of one period on the input pin (between two rising edges). If we additionally detect the falling edge in between, the counter's value gives us the duty cycle when related to the overall period length.

The reciprocal method's resolution depends on the counter's clock speed; if driven at 48 MHz, the tick period is 20.83 ns, which defines the granularity of our time

measurement. It is common to measure several pulses and average the obtained values to further increase the precision.

We can easily achieve a sub-hertz resolution with this method, but its performance degrades at high frequencies where the time measurement precision becomes insufficient. The input frequency range can be extended using a hardware prescaler¹, which is also applicable to the direct method, should the measurement of frequencies outside the counter's supported range be required. A duty cycle measurement available in this method can be used to read the output of sensors that use a pulse-width modulation.

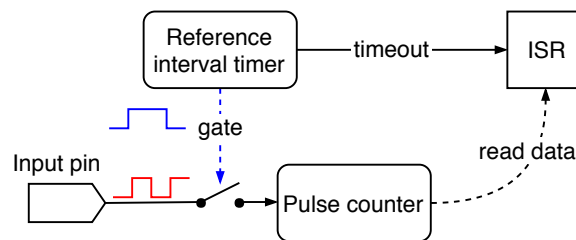

Figure 8.1: Direct frequency measurement method

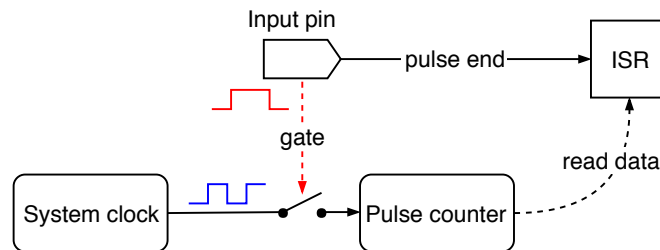

Figure 8.2: Reciprocal frequency measurement method

Which method to use depends on the frequency we want to measure; the worst-case measurement errors of both methods, assuming an ideal 48 MHz system clock, are plotted in figure 8.3. It can be seen that the reciprocal method leads in performance up to 7 kHz where the direct method overtakes it. If a higher error is acceptable, the reciprocal method could be used also for higher frequencies to avoid a reconfiguration and to take advantage of its higher speed.

A good approach to a universal measurement, when we don't know the expected frequency beforehand, could be to first obtain an estimate using the direct method, and if the frequency is below the worst-case error crossing point (here 7 kHz), to take a more precise measurement using the reciprocal method.

The system clock's frequency, which we use to measure pulse lengths and to gate the pulse counter, will be affected by tolerances of the used components, the layout of the PCB, temperature effects etc., causing measurement errors. A higher accuracy could be achieved using a **temperature-compensated oscillator (TCO)**, or, in the direct method, with the synchronization pulse provided by a **GPS** receiver to time the measurement interval.

¹*Prescaler* is a divider implemented as part of the timer/counter peripheral block that can be optionally enabled and configured to a desired division factor.

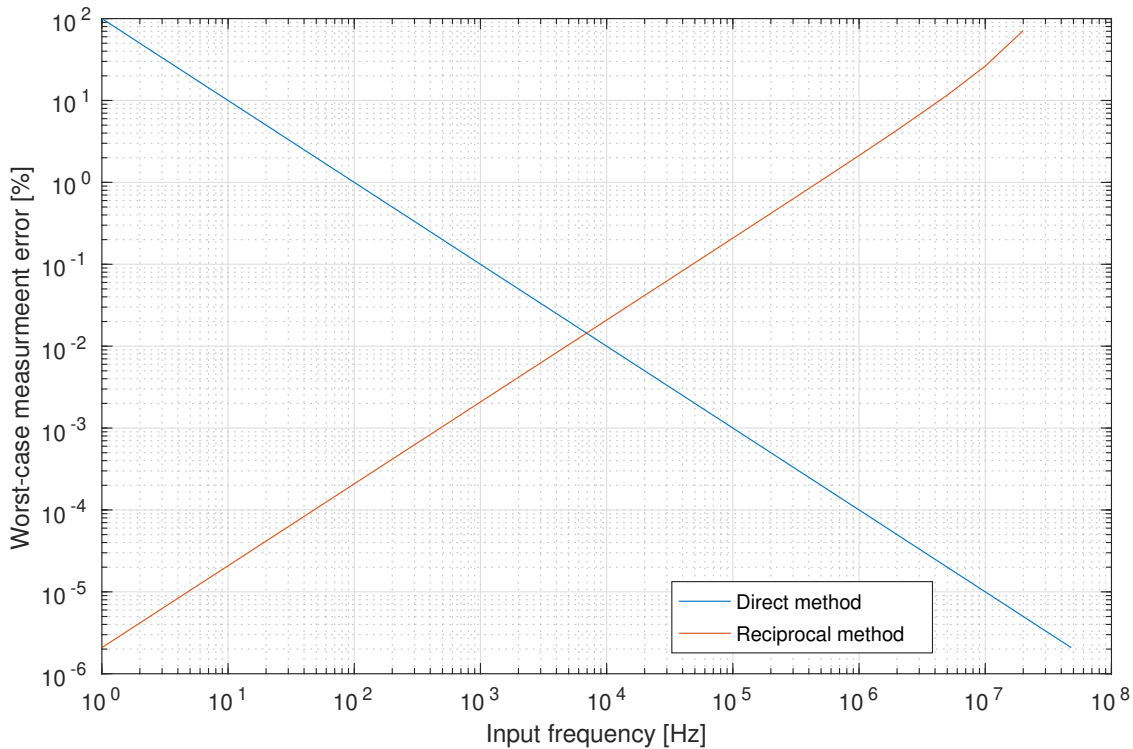

Figure 8.3: Worst-case error using the two frequency measurement methods with an ideal 48 MHz timer clock. The crossing lies at 7 kHz with an error of 0.015 %, or 1.05 Hz.

8.2 Analog Signal Acquisition

A very common need in experiments involving the measurement of physical properties is the acquisition of analog signals, respective voltages. Those can be roughly divided into **DC** and **alternating current (AC)** or time-changing signals. Analog signals are converted to digital values using **ADCs**. Several principles of analog signal measurement exist with different cost, speed, resolution, and many other factors which determine their suitability for a particular application.

DC signals can be measured by taking several samples and calculating their average value; in the presence of a 50 Hz or 60 Hz mains interference, its advisable to spread those samples over the 20 ms (resp. 16.7 ms) time of one period so that the interfering waveform cancels out. Time-changing signals can be captured by taking isochronous samples at a frequency conforming to the Nyquist theorem, that is, at least twice that of the measured signal. In practice, a frequency several times higher is preferred for a more accurate capture.

The **ADC** type commonly available in microcontrollers, including our STM32F072, uses a *successive approximation* method. It is called the *SAR type ADC*, after its main component, the **successive approximation register (SAR)**. A diagram of this **ADC** is shown in figure 8.4.

The **SAR** type converter uses a **DAC**, controlled by the value in the **SAR**, which approximates the input voltage, bit by bit, following the algorithm described in [41] and outlined below:

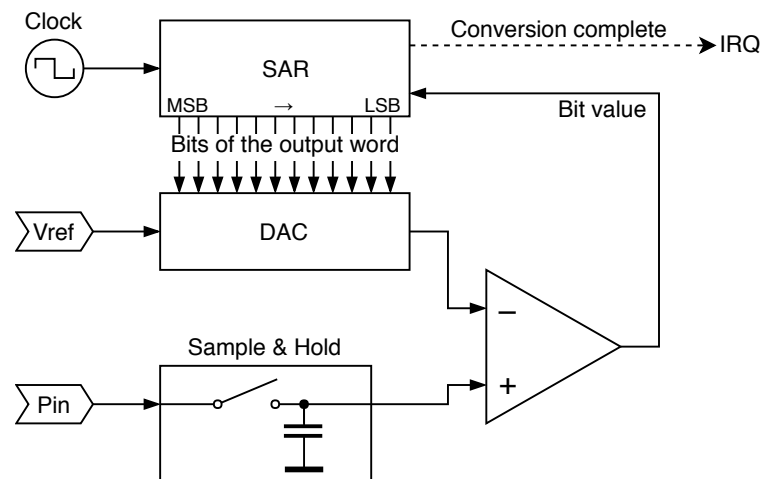

Figure 8.4: A diagram of the SAR type ADC

1. The **SAR** is cleared to all zeros.
2. The **DAC** generates an approximation voltage.
3. Its output is compared with the sampled input, and the comparator's output is stored as the active bit in the approximation register.
4. The approximation continues with step 2 and the following (less significant) bit.
5. When all bits of the data word were found, an interrupt request is generated and the application program can read it from the **SAR**.

A change of the input value would make this principle unreliable, which is why the input is buffered by a sample & hold circuit. The holding capacitor is charged to the input voltage and maintains this level during the conversion. The duration for which the capacitor is connected to the input is called a *sampling time*.

8.3 Waveform Generation

A waveform generator is a useful tool in many experiments and measurements. A sine stimulus is the basis of a lock-in amplifier; it can be used to measure impedance; with a frequency sweep, we can obtain the frequency response of an analog filter, etc. We can, of course, generate other waveforms, such as a triangle, ramp, or rectangle wave.

The **DAC** peripheral can produce a **DC** level on the output pin based on a control word. When we periodically change its digital input, it produces an analog waveform.

8.3.1 Waveform Generation with DMA and a Timer

A straightforward, intuitive implementation of the waveform generator is illustrated in figure 8.5. This approach has its advantages: it's simple and works autonomously, with no

interrupt handling or interventions from the program. It could be implemented without the use of **Direct Memory Access (DMA)** as well, using a loop periodically updating the **DAC** values; of course, such approach is less flexible and we would run into problems with interrupt handling affecting the timing accuracy.

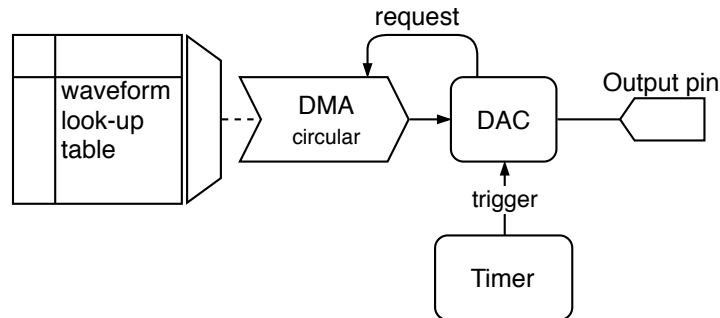

Figure 8.5: A simple implementation of the waveform generator, using DMA and a look-up table

The highest achievable output frequency largely depends on the size of our look-up table. For instance, assuming a timer frequency of 48 MHz and a 8192-word table, holding one period of the waveform, the maximum frequency would be short of 6 kHz, whereas if we shorten the table to just 1024 words, we can get almost 47 kHz on the analog output. The downside of a shorter table is a lower resolution, which will appear as **DC** plateaus or steps when observed with an oscilloscope, producing harmonic components similar to those of a square wave.

A major disadvantage of this simple generation method is given by the limitations of the used timer, which defines the output frequency. Its output trigger fires when the internal counter reaches a pre-defined value, after which the counting register is reset. The counting speed is derived from the system clock frequency f_c using a prescaler P and the set maximum value N . Only output frequencies that can be exactly expressed as $f = f_c / (P \cdot N \cdot \text{TableSize})$ can be accurately produced. Still, this simple and efficient method may be used where fine tuning is not required to take advantage of its fully asynchronous operation.

8.3.2 Direct Digital Synthesis

There are situations where the simple waveform generation method is not sufficient, particularly when a fine tuning or on-line frequency and phase changes are required. Those are the strengths of **Direct Digital Synthesis (DDS)**, an advanced digital waveform generation method well explained in [42].

A diagram of a possible **DDS** implementation in the STM32 firmware is shown in figure 8.6. It is based on a **numerically controlled oscillator (NCO)**. The **NCO** consists of a *phase accumulator* register and a *tuning word* which is periodically added to it at a constant rate in a timer interrupt handler. The value of the tuning word determines the output waveform frequency. The look-up table must have a power-of-two length so that it can be addressed by the n most significant bits of the phase accumulator. An additional control word could

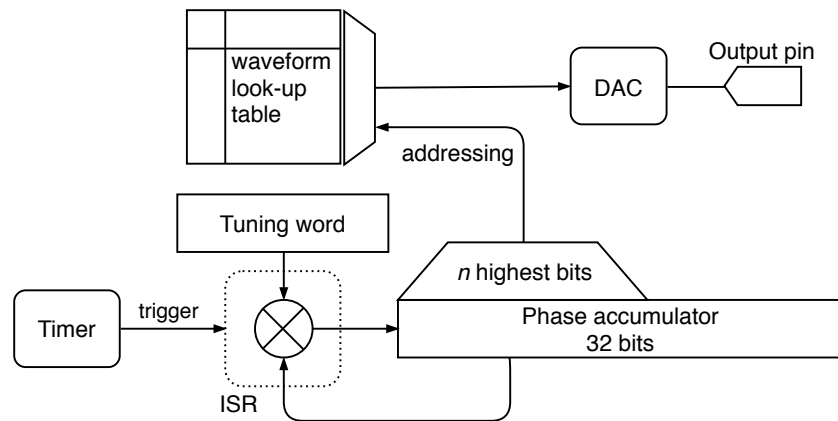

Figure 8.6: A block diagram of a DDS-based waveform generator

be added to this address to implement a phase offset for applications like a phase-shift modulation.

The output frequency is calculated as $f_{\text{out}} = \frac{M \cdot f_c}{2^n}$, where M is the tuning word, n is the bit length of the phase accumulator, and f_c is the frequency of the phase-updating interrupt. The number of bits used to address the look-up table does not affect the output frequency; the table can be as large as the storage space allows. A tuning word value exceeding the lower part of the phase accumulator (including bits which directly enter the look-up address) will cause some values from the table to be skipped. A smaller tuning word, conversely, makes some values appear on the output more than once. This can be observed as steps or flat areas on the output. When the tuning word does not evenly divide 2^n , that is, the modulo is non-zero, we can also observe jitter.

■ DDS Implemented in Hardware

DDS may be implemented in hardware, including the look-up table, often together with the DAC itself, which is then called a *Complete DDS*. That is the case of e.g. AD9833 from Analog Devices. As the software implementation depends on a periodic interrupt, it's often advantageous to use a component like this when we need higher output frequencies where the use of an interrupt is not possible. GEX can control an external waveform generator like the AD9833 using an SPI port.

■ 8.4 Touch Sensing

The used microcontroller, STM32F072, includes a **Touch Sensing Controller (TSC)** peripheral block. It can be accessed from GEX as a demonstration of capacitive touch sensing, and could possibly be used for simple touch sensors as well, such as measuring the level of water in a tank.

The TSC requires a specific topology with a sampling capacitor connected close to the microcontroller pin, which may not be possible on a universal GEX module; for this reason,

the touch sensing feature is best demonstrated on the STM32F072 Discovery development kit, which includes a 4-segment touch slider shown in figure 8.7.

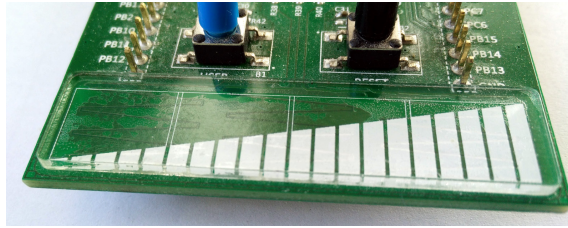

Figure 8.7: The touch slider on a STM32F072 Discovery board

The principle of capacitive touch sensing using the TSC is well explained in the microcontroller’s reference manual [43], the TSC product training materials [44, 45] and application notes from ST Microelectronics [46, 47, 48, 49]. A key part of the TSC is a set of analog switches which can be combined to form several different signal paths between external pins, Vdd, GND, and an analog comparator. Two input pins are needed for every touch sensing channel: the sensing pad connects to one, the other is connected through a sampling capacitor (47 nF on the Discovery board) to GND.

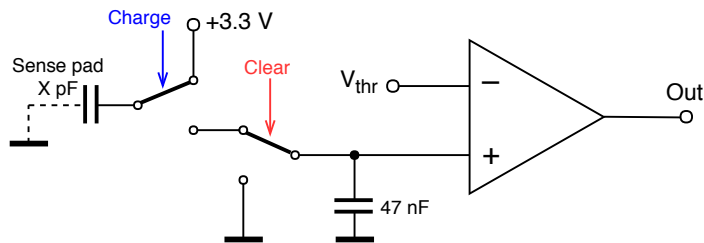

Figure 8.8: A simplified schematic of the touch sensing circuit

Capacitive sensing is a sequential process described in the following steps:

1. The sampling capacitor is discharged by connecting its free end to GND.
2. The sensing pad is connected to +3.3 V and, acting as a capacitor, charged to this voltage. It stores a small amount of charge, depending on its capacitance—this is the variable property we are trying to measure.
3. The free terminals of the two capacitors (the sensing pad and the sampling capacitor) are connected together and their voltages reach an equilibrium as a portion of the stored charge leaves the sensing pad and flows into the bigger capacitor.
4. The steps (2) and (3) are repeated until the sampling capacitor’s voltage exceeds a fixed threshold (set to a half of the supply voltage). The number of cycles needed to charge the sampling capacitor corresponds to the capacitance of the sensing pad.

A real voltage waveform measured on the sensing pad using an oscilloscope is shown in figure 8.9.

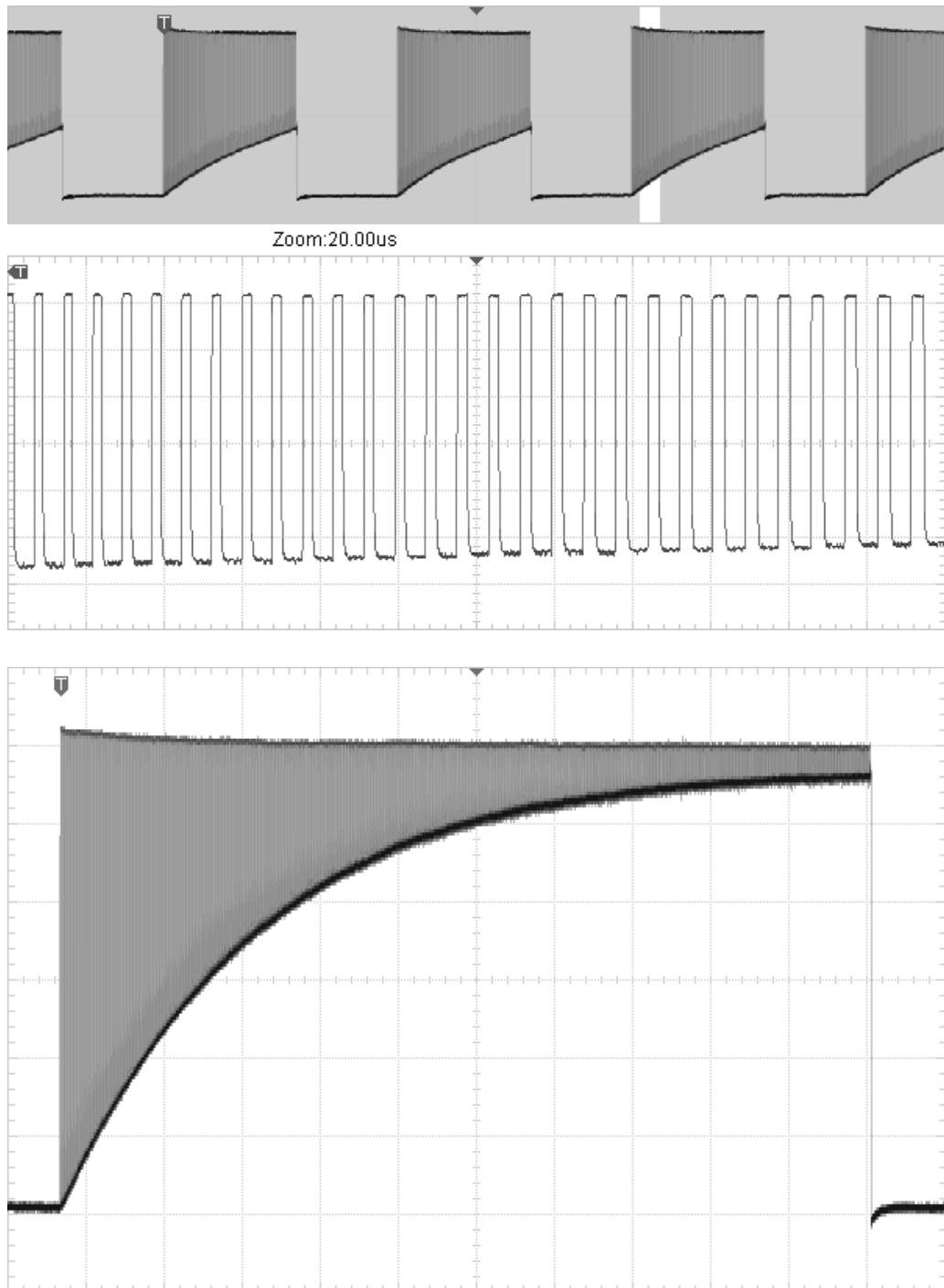

Figure 8.9: A voltage waveform measured on the touch sensing pad. The bottom side of the envelope equals the sampling capacitor's voltage—this is the phase where both capacitors are connected. The detailed view (middle) shows the individual charging cycles. The bottom screenshot captures the entire waveform, left to continue until a timeout, after the analog comparator was disabled.



Part III

Implementation

Chapter 9

Application Structure

GEX is designed to be modular and easy to extend. It's composed of a set of functional blocks (also called *units*), sometimes available in more than one instance, which can be configured by the user to fit their application needs. The firmware is built around a *core framework* which provides services to the functional blocks, such as a settings storage, resource allocation, message delivery and periodic updates.

In this chapter we will focus on the general function of the GEX module and will look at the services provided by the core framework. Individual functional blocks and the communication protocol will be described in chapters 10 and 12.

9.1 User's View of GEX

Before going into implementation details, we'll have a look at GEX from the outside, how the end user will see it. This should give the reader some context to better orient themselves in the following sections and chapters investigating the internal structure of the firmware and the communication protocol.

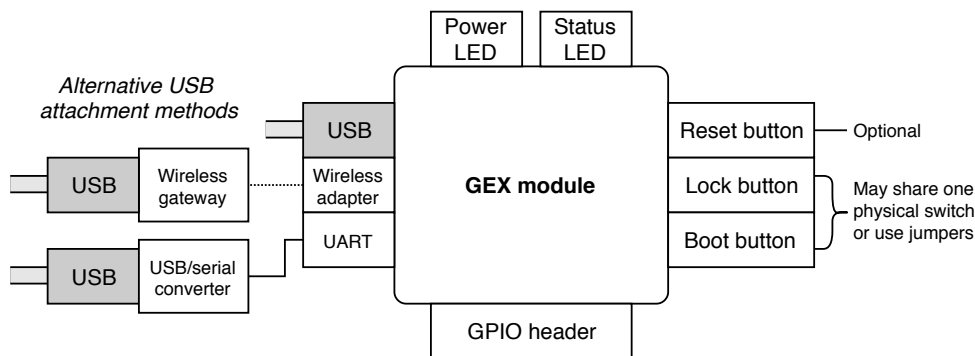

Figure 9.1: Physical user interface of a GEX module

The GEX firmware can be flashed to a STM32 Nucleo or Discovery board or a custom PCB. It's equipped with a USB connector to connect to the host PC. GEX loads its configuration from the Flash memory, configures its peripherals, sets up the function blocks and enables the selected communication interface(s).

The physical user interface of the module is shown in figure 9.1. When a USB cable connects the board to a PC, the PC OS enumerates it and either recognizes the communication

interface as **CDC/ACM** (Virtual serial port), or leaves it without a software driver attached, to be accessed directly as raw **USB** endpoints, based on GEX settings. The connection using a physical UART and a USB/UART adapter works in a very similar way, as does the wireless connection (described in more detail below).

■ 9.1.1 Updating GEX Settings

Two ways exist in which the module's settings can be modified: via the virtual Mass Storage disk, and through the control interface. We'll look at the file system method here; the API for a programmatic loading and updating of configuration will be explained in section 10.4.

The board is equipped with a button or a jumper labeled Lock. When the button is pressed or the jumper removed (or inserted, the polarity is configured in the firmware), the Mass Storage **USB** interface is enabled. For the user, this means that a new disk will appear on their computer which they can open in a file manager. The disk provides a read/write access to configuration files.

The user edits a file as needed and saves it back to the disk. GEX processes the new content, tries to apply the changes and generates an updated version that includes any error messages or newly generated sections (when a new unit was registered). For the **PC OS** to recognize this change, the Mass Storage device momentarily reports that the media is unavailable to force the **OS** to reload it. This is a similar mechanism to what happens when a memory card is removed from a reader. Now the user can reload the file in their editor, inspect the updated content and correct any possible mistakes. The settings, when applied successfully, should be immediately available to test using the communication interface. When everything is to the user's satisfaction, the updated settings are committed to the device's Flash memory by pressing the LOCK button again, or replacing the jumper.

■ 9.1.2 Connecting Using the Wireless Module

In the case when a wireless module is installed on the **PCB** and GEX is configured to use it, the radio link becomes a fallback connection when the **USB** peripheral does not get enumerated within a short time after start-up.

To use it, the user needs to connect a wireless gateway module to their host **PC** and use the radio link instead of a **USB** cable. This connection works in a way similar to the hardware UART interface: it can be used to read and modify the configuration files and to access the functional blocks; the difference lies in a slightly different protocol required to communicate with the gateway itself, e.g. to pair it with the GEX module.

■ 9.1.3 Using the Control Interface

Now that GEX is connected and configured, the user can start using it. This involves writing a program in C or Python that uses the GEX client library, using the Python library from MATLAB, or controlling GEX using a **GUI** front-end built on those libraries. The configuration can be stored in the module, but it's also possible to temporarily replace

it using the control **API**. This way, the settings are loaded automatically when the user's program starts and may differ for different programs.

9.2 Internal Structure Block Diagram

The data flows and other internal logic of the firmware are depicted in figure 9.2, with more explanation following in this chapter. The interchangeable role of the three communication interfaces can be clearly seen in the diagram, as well as the central role of the message queue which decouples interrupts from the processing thread.

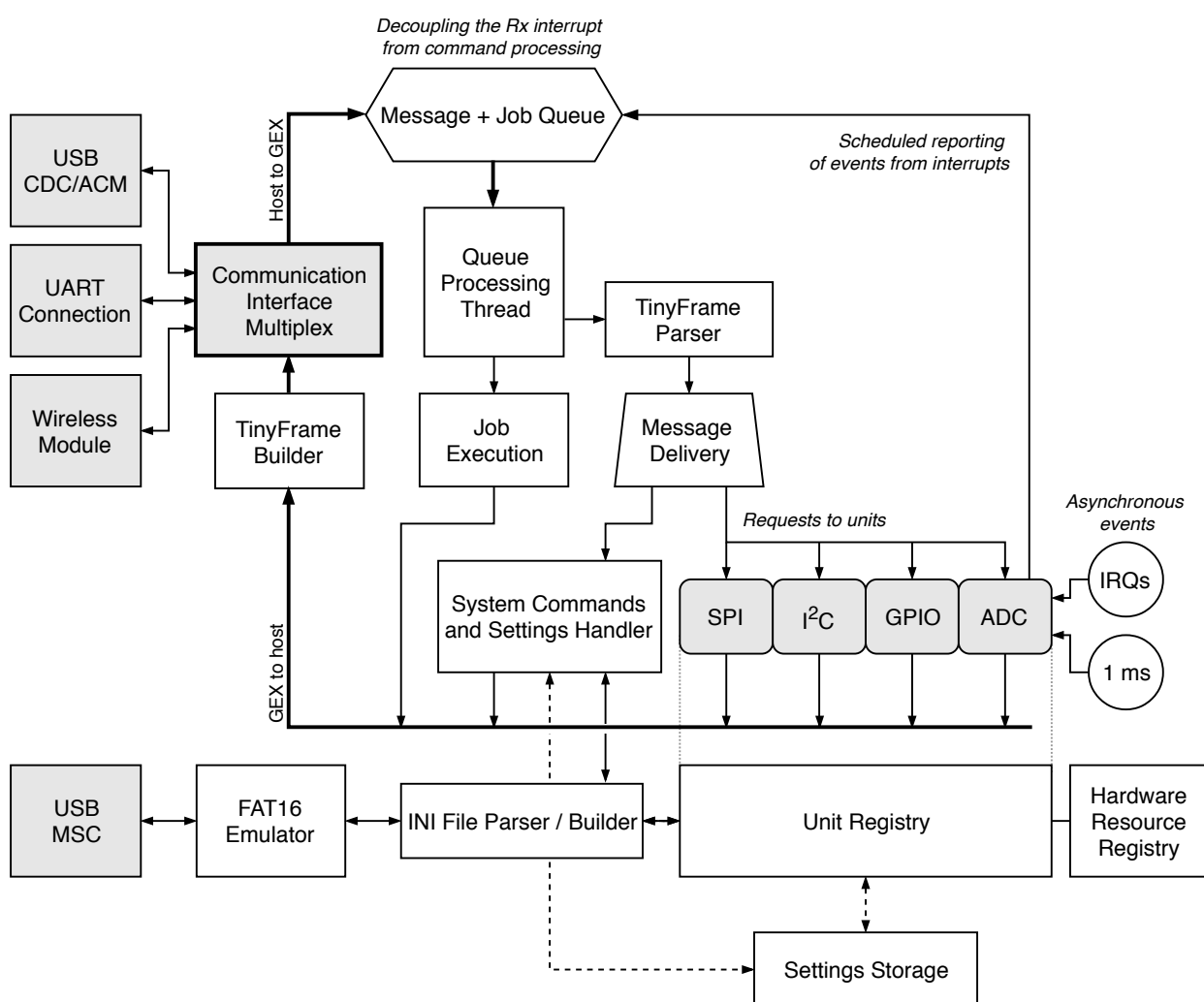

Figure 9.2: Block diagram showing the internal logic in the GEX firmware

9.3 FreeRTOS Synchronization Objects Usage

The firmware is built on FreeRTOS (5) and a number of its synchronization objects and patterns are used to make its operation more robust.

9.3.1 Message and Job Queue

The message and job queue, seen in figure 9.2, is used to decouple asynchronous interrupts from message transmission. All three communication interfaces use interrupts for the asynchronous handling of incoming messages. The same interrupt handler receives an event after a transmission was completed. The queue ensures that messages can be received during the transmission of a large response that demands the use of multiple transmissions.

The “transmission complete” interrupt signals this fact to the message processing task using a binary semaphore. The semaphore is released in the interrupt and take before a new block of data is transmitted. If more data needs to be transmitted, the queue task waits on the semaphore and enters a Blocked state until the semaphore becomes available again.

Two mutexes are used in the firmware: one that guards access to TinyFrame until the previous message was fully transmitted, and one to guard a shared memory buffer used, among other, by unit drivers during the serialization and parsing of a configuration file. The hardware resource registry (explained in 9.6.1) does not need mutexes for individual resources, as a concurrent access to those fields can never happen thanks to the way the system is organized.

9.4 Functional Blocks

GEX’s user-facing functions are implemented in *unit drivers*. Those are mutually independent modules in the firmware that the user can enable and configure using a configuration file. There can be multiple instances of each unit type. However, we are limited by hardware constraints: e.g., there may be only one ADC peripheral, two SPI ports and so on. The assignment of those hardware resources to units is handled by the *resource registry* (9.6.1).

Each unit is defined by a section in the configuration file `UNITS.INI`. It is given a name and a *callsign*, which is a number that serves as an address for message delivery. A unit is internally represented by a data object with the following structure:

- Name
- Callsign (one byte)
- Configuration parameters loaded from the unit settings
- State variables updated at run-time by user commands or internal functions
- A reference to the unit driver

The unit driver handles commands sent from the host **PC**, initializes and de-initializes the unit based on its settings, and implements other aspects of the unit's function, such as periodic updates and interrupt handling. Unit drivers may expose public **API** functions to make it possible to control the unit from a different driver, allowing the creation of "macro units".

9.5 Source Code Layout

Looking at the source code repository (fig. 9.3), at the root we'll find the device specific driver libraries and support files provided by ST Microelectronics, the FreeRTOS middleware, and a folder called **User** containing the GEX application code. This division is useful when porting the firmware to a different microcontroller, as the GEX folder is mostly platform-independent and can be simply copied (of course, adjustments are needed to accompany different hardware peripheral versions etc.). The GEX core framework consists of everything in the **User** folder, excluding the **units** directory in which the individual units are implemented. Each unit driver must be registered in the file `platform.c` to be available for the user to select. The file `plat_compat.c` includes platform-specific headers and defines e.g. which pin to use for a status **LED** or the **LOCK** button.

The **USB** Device library, which had to be modified to support a composite class, is stored inside the **User** folder too, as it is compatible with all STM32 microcontrollers that support **USB**.

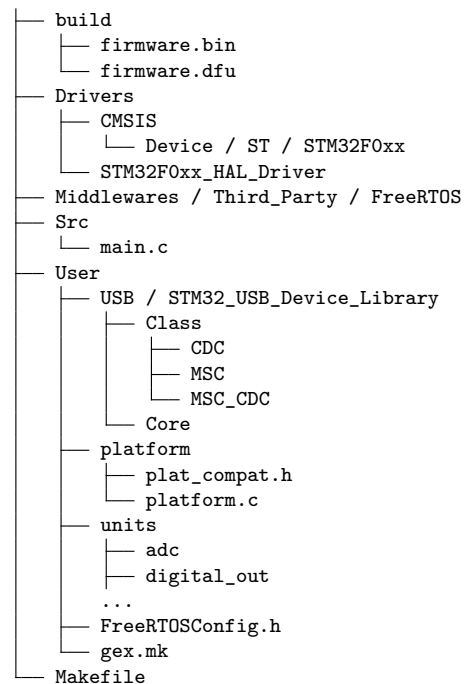

Figure 9.3: The general structure of the source code repository

9.6 Functions of the Core Framework

The core framework forms the skeleton of the firmware and usually doesn't need any changes when new user-facing features are added. It provides the following services:

- Hardware resource allocation (9.6.1)
- Settings storage and loading (9.6.2)
- Functional block (*units*) initialization (9.4)
- The communication port with different back-ends: **USB**, **UART**, wireless (9.6.3)
- Message sending and delivery (9.6.4)

- Interrupt management and routing to functional blocks (9.6.5)
- Virtual mass storage for configuration file editing

When the firmware needs to be ported to a different STM32 microcontroller, the core framework is relatively straightforward to adapt and the whole process can be accomplished in a few hours. The time consuming part is modifying the functional blocks to work correctly with the new device's hardware.

9.6.1 Resource Allocation

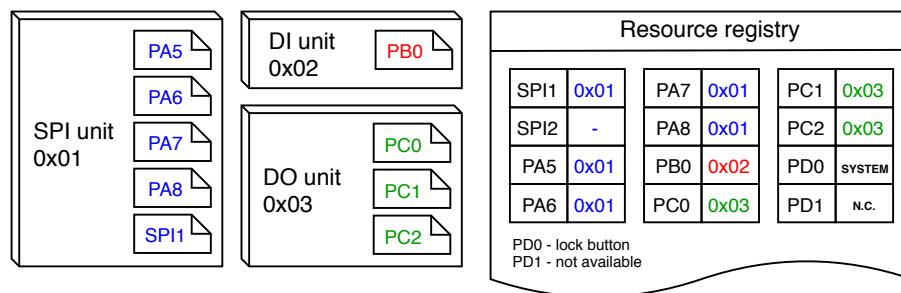

Figure 9.4: An example allocation in the resource registry

The microcontroller provides a number of hardware resources that require exclusive access: GPIO pins, peripheral blocks (**SPI**, **I²C**, **UART**...), **DMA** channels. If two units tried to control the same pin, the results would be unpredictable; similarly, with a multiple access to a serial port, the output would be a mix of the data streams and completely useless.

To prevent a multiple access, the firmware includes a *resource registry* (fig. 9.4). Each individual resource is represented by a field in a resource table together with its owner's callsign. Initially all resources are free, except for those not available on the particular platform (i.e. a GPIO pin PD1 may be disabled if not present on the microcontroller's package).

The resources used by the core framework are taken by a virtual unit **SYSTEM** on start-up to prevent conflicts with the user's units. This is the case of the status **LED**, the **LOCK** button, **USB** pins, the communication **UART**, the pins and an **SPI** peripheral connecting the wireless module, pins used for the crystal oscillator, and the timer/counter which provides the system timebase.

9.6.2 Settings Storage

The system and unit settings are written, in a binary form, into designated pages of the microcontroller's Flash memory. The unit settings serialization and parsing is implemented by the respective unit drivers.

As the settings persist after a firmware update, it's important to maintain backwards compatibility. This is achieved by prefixing the unit's settings by a version number. When

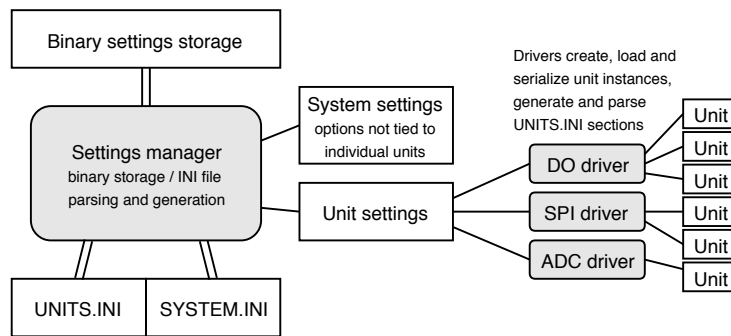

Figure 9.5: Structure of the settings subsystem

the settings are loaded by a new version of the firmware, it first checks the version and decides whether to use the old or new format. When the settings are next changed, the new format will be used.

The INI files, which can be edited through the communication **API** or using a text editor with the virtual mass storage, are parsed and generated on demand and are never stored in the Flash or **RAM**, other than in short temporary buffers. The INI parser processes the byte stream on-the-fly as it is received, and a similar method is used to build a INI file from the configured units and system settings.

■ 9.6.3 Communication Ports

The firmware supports three different communication ports: hardware **UART**, **USB** (virtual serial port), and a wireless connection. Each interface is configured and accessed in a different way, but for the rest of the firmware (and for the **PC**-side application) they all appear as a full duplex serial port. To use interfaces other than **USB**, the user must configure those in the system settings (a file **SYSTEM.INI** on the configuration disk).

At start-up, the firmware enables the **USB** peripheral, configures the device library and waits for enumeration by the host **PC**. When not enumerated, it concludes the **USB** cable is not connected, and tries some other interface. The **UART** interface can't be tested as reliably, but it's possible to measure the voltage on the Rx pin. When idle, a **UART** Rx line should be high (here 3.3 V). The wireless module, when connected using **SPI**, can be detected by reading a register with a known value and comparing those.

■ USB Connection

GEX uses vid:pid 1209:4c60 and the wireless gateway 1209:4c61. The **USB** interface uses the **CDC/ACM USB** class (4.3.2) and consists of two bulk endpoints with a payload size of up to 64 bytes.

■ Communication UART

The parameters of the communication **UART** (such as the baud rate) are defined in **SYSTEM.INI**. It's mapped to pins PA2 and PA3; this is useful with STM32 Nucleo boards

that don't include a User **USB** connector, but provide a **USB**-serial bridge using the on-board ST-Link programmer, connected to those pins.

This is identical to the **USB** connection from the **PC** application's side, except a physical **UART** is necessarily slower and does not natively support flow control. The use of the Xon and Xoff software flow control is not practical with binary messages that could include those bytes by accident, and the ST-Link **USB**-serial adapter does not implement hardware flow control.

■ Wireless Connection

The wireless connection uses an on-board communication module and a separate device, a wireless gateway, that connects to the **PC**. The wireless gateway is interfaced differently from the GEX board itself, but it also shows as a virtual serial port on the host **PC**. This is required to allow communicating with the gateway itself through the **CDC/ACM** interface in addition to addressing the end devices.

This interface will be explained in more detail in chapter 11.

■ 9.6.4 Message Passing

One of the key functions of the core framework is to deliver messages from the host **PC** to the right units. This functionality resides above the framing protocol, which will be described in chapter 10.

A message that is not a response in a multi-part session (this is handled by the framing library) is identified by its Type field. Two main groups of messages exist: *system messages* and *unit messages*. System messages can access the INI files, query a list of the available units, restart the module etc. Unit messages are addressed to a particular unit by their callsign (see 9.4), and their payload format is defined by the unit driver. The framework reads the message type, then the callsign byte, and tries to find a matching unit in the unit list. If no unit with the callsign is found, an error response is sent back, otherwise the unit driver is given the message to handle it as required.

The framework provides one more messaging service to the units: event reporting. An asynchronous event, such as an external interrupt, an **ADC** trigger or an **UART** data reception needs to be reported to the host. This message is annotated by the unit callsign so the user application knows it's origin.

■ 9.6.5 Interrupt Routing

Interrupts are an important part of almost any embedded application. They provide a way to rapidly react to asynchronous external or internal events, temporarily leaving the main program, jumping to an interrupt handler routine, and then returning back after the event is handled. Interrupts are also the way FreeRTOS implements multitasking without a multi-core processor.

In the Cortex-M0-based STM32F072, used in the initial GEX prototypes, the interrupt handlers table, defining which routine is called for which interrupt, is stored in the program

memory and can't be changed at run-time. This is a complication for the modular structure of GEX where different unit drivers may use the same peripheral, and we would want to dynamically assign the interrupt handlers based on the active configuration. Let's have a look at an interrupt handler, in this case handling four different **DMA** channels, as is common in STM32 microcontrollers:

```
void DMA1_Channel4_5_6_7_IRQHandler(void)
{
    if (LL_DMA_IsActiveFlag_GI4(DMA1)) { /* handle DMA1 channel 4 */ }
    if (LL_DMA_IsActiveFlag_GI5(DMA1)) { /* handle DMA1 channel 5 */ }
    if (LL_DMA_IsActiveFlag_GI6(DMA1)) { /* handle DMA1 channel 6 */ }
    if (LL_DMA_IsActiveFlag_GI7(DMA1)) { /* handle DMA1 channel 7 */ }
}
```

It is evident that multiple units might need to use the same interrupt handler, even at the same time, since each **DMA** channel is configured, and works, independently. GEX implements a redirection scheme to accomplish such interrupt sharing: All interrupt handlers are defined in one place, accompanied by a table of function pointers. When a unit driver wants to register an interrupt handler, it stores a pointer to it in this redirection table. Then, once an interrupt is invoked, the common handler checks the corresponding entry in the table and calls the referenced routine, if any. Conversely, when a unit driver deinitializes a unit, it removes all interrupt handlers it used, freeing the redirection table slots for other use.

Chapter 10

Communication Protocol

GEX can be controlled through a hardware **UART**, the **USB** or over a wireless link. To minimize the firmware complexity, all the three connection methods are handled by the same protocol stack and are functionally interchangeable.

The communication is organized in transactions. A transaction consists of one or more messages going in either direction. Messages can be stand-alone, or chained with a response or a follow-up message using the transaction ID. Both peers, GEX and the client application running on the host PC, are equal in the communication: either side can independently initiate a transaction at any time.

GEX uses a framing library *TinyFrame* [50], developed likewise by the author, but kept as a separate project for easier re-use in different applications. The library implements frame building and parsing, checksum calculation and a system of message listeners.

10.1 Frame Structure

Message frames have the following structure (all little-endian):

“TinyFrame” frame structure, as used in GEX

- **u8** start-of-frame marker (0x01)
- **u16** frame ID
- **u16** payload length
- **u8** frame type
- **u8** header checksum
- **u8[]** payload
- **u8** payload checksum (omitted for empty payloads)

Frame ID, which could be better described as *Transaction ID*, uniquely identifies each transaction. The most significant bit is set to a different value in each peer to avoid ID conflicts, and the rest of the ID field is incremented with each initiated transaction.

10.2 Message Listeners

After sending a message that should receive a response, the peer registers an *ID listener* with the ID of the sent message. A response reuses the original frame ID and when it is received, this listener is called to process it. ID listeners can also be used to receive multi-part messages re-using the original ID.

Frame type describes the payload and does not have any prescribed format; the values are defined by application (here, GEX). A *type listener* may be registered to handle all incoming messages with a given frame type. It works in a similar way to an ID listener and has a lower priority.

Each message can be handled by only one listener, unless it explicitly requests the message to be passed on to a lower priority one. Messages unhandled by any listener are given to a default listener, which can e.g. write an error to a debug log.

10.3 Designated Frame Types

The following table lists all frame types used by GEX. It is divided into four logical sections: General, Bulk Read/Write, Unit Access, and Settings.

Frame type	Function	Note
0x00	Success	<i>Payload depends on context</i>
0x01	Ping	<i>GEX responds with Success and its version string</i>
0x02	Error	<i>Payload contains the error message</i>
0x03	Bulk Read Offer	<i>An offer of data to read using 0x04</i>
0x04	Bulk Read Poll	<i>Requesting to read a block of data</i>
0x05	Bulk Write Offer	<i>An offer to receive a bulk write transaction</i>
0x06	Bulk Data	<i>Used for both reading and writing</i>
0x07	Bulk End	<i>Marks the last “Bulk Data” frame</i>
0x08	Bulk Abort	
0x10	Unit Request	<i>Request to a unit</i>
0x11	Unit Report	<i>Spontaneous event generated by a unit</i>
0x20	List Units	<i>Read a list of all instantiated units</i>
0x21	INI Read	<i>Request a bulk read transaction of an INI file</i>
0x22	INI Write	<i>Request a bulk write transaction of an INI file</i>
0x23	Persist Config	<i>Write updated configuration to Flash</i>

10.4 Bulk Read and Write Transactions

The bulk read and write transactions are generic, multi-message exchanges which are used to transfer the INI configuration files. They could additionally be used by some future unit requiring to transfer a large amount of data (e.g. to read image data from a camera).

The reason for splitting a long file into multiple messages, rather than sending it all in one, lies in the hardware limitations of the platform, specifically its small amount of **RAM** (the STM32F072 has only 16 kB). A message cannot be processed until its payload checksum is received and verified; however, the configuration file can have several kilobytes, owing to the numerous explanatory comments, which would require a prohibitively large data buffer. The chunked transaction could, additionally, be extended to support message re-transmission on timeout without sending the entire file again.

A read or write transaction can be aborted by a frame 0x08 (Bulk Abort) at any time, though aborting a write transaction may leave the configuration in a corrupted state. As hinted in the introduction of this chapter, a transaction is defined by sharing a common frame ID. Thus, all frames in a bulk transaction must have the same ID, otherwise the ID listeners won't be called for the subsequent messages, and the transaction will time out.

Figure 10.1 shows a diagram of the bulk read and write data flow.

10.4.1 Bulk Read

To read an INI file, we first send a frame 0x21 (INI Read), specifying the target file in the payload:

<i>INI Read frame structure</i>
<ul style="list-style-type: none"> • u8 which file to write <ul style="list-style-type: none"> – 0 ... UNITS.INI – 1 ... SYSTEM.INI

What follows is a standard bulk read transaction with the requested file. GEX offers the file for reading with a frame 0x03 (Bulk Read Offer):

<i>Bulk Read frame structure</i>
<ul style="list-style-type: none"> • u32 full size of the file in bytes • u32 largest chunk that can be read at once

Now we can proceed to read the file using 0x04 (Bulk Read Poll), which is always responded to with 0x06 (Bulk Data), or 0x07 (Bulk End) if this was the last frame. Data frames have only the useful data as their payload.

The 0x04 (Bulk Read Poll) payload specifies how many bytes we want to read:

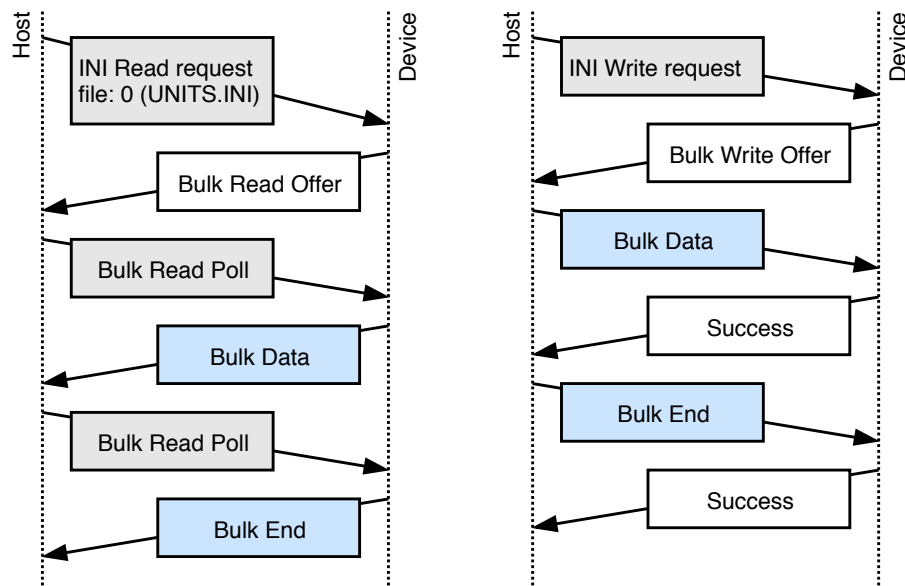

Figure 10.1: A diagram of the bulk read and write transaction.

Bulk Read Poll frame structure

- **u32** how many bytes to read (at most)

■ 10.4.2 Bulk Write

To overwrite an INI file, we first send a frame 0x22 (INI Write) with the file size as its payload. The name of the file is irrelevant, as it's detected automatically by inspecting the content.

INI Write frame structure

- **u32** size of the written file, in bytes

The write request is confirmed by a frame 0x05 (Bulk Write Offer) sent back:

Bulk Write Offer frame structure

- **u32** total bytes to write (here copied from the request frame)
- **u32** how many bytes may be written per message

We can now send the file as a series of frames 0x06 (Bulk Data), or 0x07 (Bulk End) in the last frame, with chunks of the data as their payload. Each frame is confirmed by 0x00 (Success).

<i>Bulk Data or Bulk End frame structure</i>
<ul style="list-style-type: none"> • <code>u8 []</code> a chunk of the written file

10.4.3 Persisting the Changed Configuration to Flash

The written INI file is immediately parsed and the settings are applied. However, those changes are not persistent: they exist only in RAM and will be lost when the module restarts. To save the current state to Flash, issue a frame 0x23 (Persist Config). This has the same effect as pressing the LOCK button (or replacing the LOCK jumper) when the INI files are edited using the virtual mass storage.

It should be noted that after flashing a firmware, the Flash control registers may remain in an unexpected state and the module must first be manually restarted before attempting to persist settings. Otherwise an assertion will fail and the module is restarted by a watchdog, losing the temporary changes.

10.5 Reading a List of Units

The frame 0x20 (List Units) requests a list of all available units in the GEX module. The list includes all units' callsigns, names and types. The response payload has the following format (in pseudocode):

<i>List Units response structure (frame type Success)</i>
<ul style="list-style-type: none"> • <code>u8</code> the number of available units • For each unit: <ul style="list-style-type: none"> – <code>u8</code> unit callsign – <code>char []</code> unit name (zero-terminated string) – <code>char []</code> unit type (zero-terminated string)

10.6 Unit Requests and Reports

Frame types 0x10 (Unit Request) and 0x11 (Unit Report) are dedicated to messages sent to and by unit instances. Each has a fixed header (*inside the payload*) followed by unit-specific data.

10.6.1 Unit Requests

Unit requests deliver a message from the host to a unit instance. Unit drivers implements different commands, each with its own payload structure. The frame 0x10 (Unit Request) has the following structure:

Unit Request frame structure

- **u8** unit callsign
- **u8** command number, handled by the unit driver
- **u8[]** command payload, handled by the unit driver; its size and content depend on the unit driver and the particular command number

The most significant bit of the command byte (0x80) has a special meaning: when set, the message delivering routine responds with 0x00 (Success) after the command completes, unless an error occurred. That is used to get a confirmation that the message was delivered and the module operates correctly (as opposed to e.g. a lock-up resulting in a watchdog reset). Requests which normally generate a response (e.g. reading a value from the unit) should not be sent with this bit set. As a result of this special treatment of the highest bit, there can be only 127 different commands per unit.

■ 10.6.2 Unit Reports

Several unit types can produce asynchronous events, such as reporting a pin change or a triggering condition. The event is timestamped and sent with a frame type 0x11 (Unit Report):

Unit Report (event) frame structure

- **u8** unit callsign
- **u8** report type, defined by the unit driver
- **u64** event time (microseconds since power-on)
- **u8[]** report payload; its size and content depend on the unit driver and the particular report type

Chapter 11

Wireless Interface

Four methods of a wireless connection have been considered: Bluetooth (e.g. with CC2541), WiFi with ESP8266, a 868 MHz long range link with SX1276, and a 2.4 GHz link with nRF24L01+. Bluetooth was dismissed early for its complexity, and ESP8266 for its high consumption in continuous reception mode, although both solutions might be viable for certain applications and with more development time.

The Semtech SX1276 [51] and Nordic Semiconductor nRF24L01+ [52] transceivers have both been tested using the first GEX prototype, proving its usefulness as a hardware development tool, and it has been confirmed they could fulfill the requirements of our application.

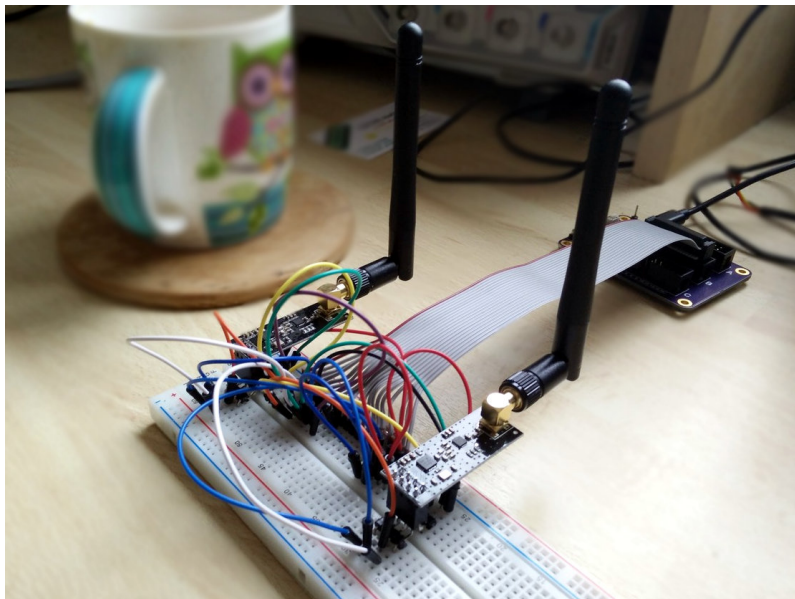

Figure 11.1: Test setup with a GEX prototype controlling two nRF24L01+ modules

11.1 Modulations Overview

A brief overview of the different signal modulation techniques is presented here to aid the reader with understanding of table 11.1 and the rest of the chapter.

■ 11.1.1 On-Off Keying (OOK)

In **on-off keying (OOK)**, the carrier generator is switched on and off to transmit ones and zeros.

■ 11.1.2 Frequency Shift Keying (FSK)

Frequency-shift keying (FSK) uses a change of the carrier frequency to transmit data. The simplest form of **FSK** is **binary frequency-shift keying (BFSK)**, which uses a pair of alternating frequencies to transmit ones and zeros.

■ 11.1.3 Gaussian Frequency Shift Keying (GFSK)

Gaussian frequency-shift keying (GFSK) is an improvement over basic **FSK** which does not switch between the different frequencies instantaneously, but uses a Gaussian filter to make the changes less abrupt, which reduces the side-band interference otherwise generated by the sharp edges. This scheme can be imagined as sending the binary waveform through a Gaussian filter and then modulating a **VCO** with its output, rather than changing the **VCO**'s control voltage discretely. **GFSK** is used in the Bluetooth standard.

■ 11.1.4 Minimum-Shift Keying (MSK)

Minimum-shift keying (MSK) is another **FSK**-based modulation scheme. In **MSK**, the frequencies representing different symbols are chosen such that there are no sharp changes in the phase of the output waveform, the modulation is *phase-coherent*. This is another way to reduce side-band interference.

■ 11.1.5 Gaussian Minimum-Shift Keying (GMSK)

Gaussian minimum-shift keying (GMSK) is a variant of **MSK** which uses a Gaussian filter to shape the digital signal before sending it to the oscillator. The principle is similar to **GFSK**, and it is a yet another way to reduce side-band interference and increase spectral efficiency. **GMSK** is used in the **Global System for Mobile communications (GSM)**.

■ 11.1.6 LoRa Modulation

LoRa is a patented proprietary modulation developed by Semtech. It uses a direct sequence frequency hopping spread spectrum modulation and can achieve very long range transmission (over 10 km is not uncommon). LoRa is available only with transceiver **ICs** produced by Semtech and for this reason it is rather expensive.

■ 11.2 Comparing SX1276 and nRF24L01+

The two transceivers are compared in table 11.1. It's apparent that each has its strengths and weaknesses, discussed below.

Parameter	SX1276	nRF24L01+
Connection	SPI (4 pins) + up to 6 IRQ	SPI (4 pins), CE, IRQ
Frequency band	868 MHz or 433 MHz	2.4 GHz
Data rate	up to 300 kbps	250–2000 kbps
Modulation	(G)FSK, (G)MSK, OOK, LoRa	GFSK
Range (est.)	over 10 km	up to 1 km
Consumption Rx	10.8–12 mA	12.6–13.5 mA
Consumption Tx	20–120 mA	7–11.3 mA
Idle power (max)	1 μ A sleep, 2 mA stand-by	0.9 μ A sleep, 320 μ A stand-by
Max packet size	300 bytes	32 bytes
Reset	NRESET pin	Vdd disconnect
Extra	LoRa FHSS, packet engine	ShockBurst protocol engine
Price	\$7.3	\$1.6

Table 11.1: Comparison of the SX1276 and nRF24L01+ wireless transceivers, using data from their datasheets (price in USD from DigiKey in a 10 pcs. quantity, recorded on May 6th 2018)

SX1276 supports additional modulation modes, including a proprietary LoRa scheme with a frequency-hopping spread spectrum modulation that can be received at a distance up to 20 km in ideal conditions. The long-range capability is reflected in a higher consumption during transmission. However, its consumption in receiver mode is slightly lower than that of the nRF24L01+.

nRF24L01+ provides higher data rates at short distances. Its power consumption is comparable or lower than that of the SX1276. It lacks a dedicated reset pin, but that can be easily worked around using an external transistor to momentarily disconnect its Vdd pin.

Both devices implement some form of a packet engine with error checking; that of the nRF24L01+, called ShockBurst, is more advanced as it implements acknowledgment responses and automatic re-transmission, leading to a potentially more robust communication without an additional overhead on the side of the microcontroller.

11.3 Integration of the nRF24L01+ into GEX

The nRF24L01+ was selected to be integrated into GEX thanks to its inclusion of the ShockBurst engine, higher possible data rates and significantly lower price. The SX1276, nonetheless, remains an interesting option that could be used as an alternative in the future, should the need for a long range communication arise.

A separate device, the *GEX wireless gateway*, was developed to provide the PC connection to a nRF24L01+ module. It is based on the STM32F103 microcontroller in its smallest package (LQFP48), selected for its low cost and good availability.

[more about the hardware](#)

11.3.1 The Wireless Gateway Protocol

The gateway presents itself to the host as a **CDC/ACM** device, much like the GEX modules themselves (here called *nodes*) when connected over **USB**. It implements a simple protocol which encapsulates the binary data sent to or from a connected node. The wrapped GEX protocol, which is described in chapter 10, remains unchanged.

The gateway has a 4-byte network ID, a number derived from the **MCU**'s unique ID by calculating its 32-bit **cyclic redundancy check (CRC)**. The network ID must be entered into all nodes that wish to communicate with the gateway. Additionally, each module is assigned a 1-byte number which serves as its address in the network. The gateway can receive messages from up to 6 nodes.

All messages sent to or from the gateway are a multiple of 64 bytes long, padded with zeros if shorter. The message starts with a control byte determining its type, as summarized in the following table:

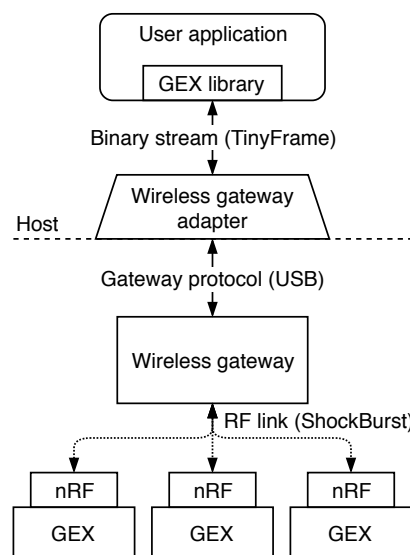

Figure 11.2: A block diagram of the wireless connection

First byte	Function	Structure
'r' (114)	RESTART Restart the gateway, disconnecting all nodes. This is functionally equivalent to re-plugging it to the USB port.	
'i' (105)	GET_NET_ID Read the unique 4-byte network ID. This command has no side effects and may be used as “ping” to verify the USB connection.	<i>Response:</i> <ul style="list-style-type: none"> • 0x01 • u8[4] network ID
'n' (110)	ADD_NODES Configure the gateway to listen for messages from the given nodes. Nodes may be removed using the RESTART command.	<i>Request:</i> <ul style="list-style-type: none"> • u8 count • u8[] node addresses

First byte	Function	Structure
'm' (109)	SEND_MSG Send a binary message to one of the connected nodes. The message may span multiple 64-byte frames; the subsequent frames will contain only the payload bytes, or zero padding at the end of the last one.	<i>Request:</i> <ul style="list-style-type: none"> • u8 node address • u16 length • u8 checksum (inverted XOR of all payload bytes) • u8[] payload
0x02	INCOMING_MSG A message was received from one of the configured nodes. This is an event frame sent by the gateway to the host.	<i>Payload:</i> <ul style="list-style-type: none"> • u8 node address • u8 message length • u8[] payload

11.3.2 Gateway Initialization Procedure

A host program connecting to a node or nodes through the gateway should follow the following procedure to initialize and configure the gateway:

1. Send the 'GET_NET_ID' command to test if the gateway is connected (and obtain its network ID as a side effect)
2. Restart the gateway using the 'RESTART' command to clean any possible previous configuration.
3. Add the node address(es) using 'ADD_NODES'
4. Ping the connected node(s) via TinyFrame (passed through 'SEND_MSG' and 'INCOMING_MSG') to test if the connection works.

Chapter 12

Units Overview, Commands and Events Description

This chapter describes all functional blocks (units) implemented in GEX, version 1.0. The term “unit” will be used here to refer to both unit types (drivers) or their instances where the distinction is not important.

Each unit’s description will be accompanied by a corresponding snippet from the configuration file, and a list of supported commands and events. The commands and events described here form the payload of TinyFrame messages 0x10 (Unit Request) and 0x11 (Unit Report), as described in section 10.6. The number in the first column of the command (or event) tables, marked as “Code”, is the command number (or report type) used in the payload to identify how the message data should be treated.

When the request or response payload is empty, it’s omitted from the table. The same applies to commands with no response, in which case adding 0x80 to the command number triggers a SUCCESS response after the command is finished.

12.1 Naming Conventions and Common Principles

12.1.1 Unit Naming

Unit types are named in uppercase (e.g. SPI, 1WIRE, NPX) in the INI file and in the list of units. Unit instances can be named in any way the user desires; using lowercase makes it easier to distinguish them from unit types. It is advisable to use descriptive names, e.g. not “pin1” but rather “button”.

12.1.2 Packed Pin Access

Several units facilitate an access to a group of GPIO pins, such as the digital input and output units, or the SPI unit’s slave select pins. The STM32 microcontroller’s ports have 16 pins each, most of which can be configured to one of several alternate functions (e.g. SPI, PWM outputs, ADC input). As a consequence, it’s common to be left with a discontinuous group of pins after assigning all the alternate functions needed by an application.

For instance, we could only have the pins 0, 1, 12–15 available on a GPIO port. GEX provides a helpful abstraction to bridge the gaps in the port: The selected pins are packed together and represented, in commands and events, as a block of six pins (0x3F) instead of their original positions in the register (0xF003). This scheme is shown in figure 12.1. The

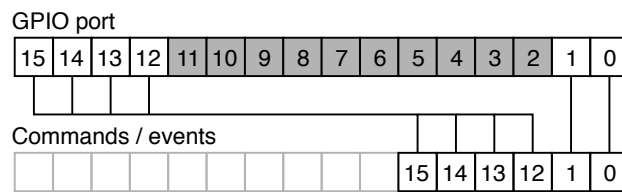

Figure 12.1: Pin packing

translation is done in the unit driver and works transparently, as if the block of pins had no gaps—all the referenced pins are updated simultaneously without glitches. Where pin numbers are used, the order in the packed word should be provided—in our example, that would be 0–5, counting from the least significant bit.

Expand unit descriptions, add diagrams... (text was written before the tables and ini snippets were added)

12.2 Digital Output

The digital output unit provides a write access to one or more pins of a GPIO port. This unit additionally supports pulse generation on any of its pins. This is implemented in software with the timing derived from the system timebase, as the hardware timer outputs, otherwise used for **PWM** or pulse generation, are available only on several dedicated pins. The timing code is optimized to reduce jitter.

Measure jitter and add it here

12.2.1 Digital Output Configuration

```
[D0:out@1]
# Port name
port=A
# Pins (comma separated, supports ranges)
pins=0
# Initially high pins
initial=
# Open-drain pins
open-drain=
```

12.2.2 Digital Output Commands

Code	Function	Structure
0	WRITE Write to all pins	<i>Request:</i> <ul style="list-style-type: none"> u16 new value

Code	Function	Structure
1	SET Set selected pins to 1	<i>Request:</i> <ul style="list-style-type: none"> • u16 pins to set
2	CLEAR Set selected pins to 0	<i>Request:</i> <ul style="list-style-type: none"> • u16 pins to clear
3	TOGGLE Toggle selected pins	<i>Request:</i> <ul style="list-style-type: none"> • u16 pins to toggle
4	PULSE Generate a pulse on the selected pins. The μs scale may be used only for 0–999 μs .	<i>Request:</i> <ul style="list-style-type: none"> • u16 pins to pulse • u8 active level (0, 1) • u8 scale: 0-ms, 1-μs • u16 duration

12.3 Digital Input

The digital input unit is the input counterpart of the digital output unit.

In addition to reading the immediate digital levels of the selected pins, this unit can generate asynchronous events on a pin change. The state of the entire input port, together with a microsecond timestamp (as is the case for all asynchronous events), is reported to the host either on a rising, falling, or any pin change.

The pin change event can be configured independently for each pin. In order to receive a pin change event, we must arm the pin first; it can be armed for a single event, or it may be re-armed automatically with a hold-off time. It's further possible to automatically arm selected pin triggers on start-up.

12.3.1 Digital Input Configuration

```
[DI:in@2]
# Port name
port=A
# Pins (comma separated, supports ranges)
pins=0
# Pins with pull-up
pull-up=
# Pins with pull-down
pull-down=

# Trigger pins activated by rising/falling edge
trig-rise=
trig-fall=
```

```
# Trigger pins auto-armed by default
auto-trigger=
# Triggers hold-off time (ms)
hold-off=100
```

12.3.2 Digital Input Events

Code	Function	Structure
0	PIN_CHANGE A pin change event. The payload includes a snapshot of all configured pins captured immediately after the change was registered.	<i>Payload:</i> <ul style="list-style-type: none"> • u16 changed pins • u16 port snapshot

12.3.3 Digital Input Commands

Code	Function	Structure
0	READ Read the pins	<i>Response:</i> <ul style="list-style-type: none"> • u16 pin states
1	ARM_SINGLE Arm for a single event	<i>Request:</i> <ul style="list-style-type: none"> • u16 pins to arm
2	ARM_AUTO Arm with automatic re-arming after each event	<i>Request:</i> <ul style="list-style-type: none"> • u16 pins to arm
3	DISARM Dis-arm selected pins	<i>Request:</i> <ul style="list-style-type: none"> • u16 pins to dis-arm

12.4 SIPO (Shift Register) Unit

The shift registers driver unit is designed for the loading of data into *serial-in, parallel-out* (SIPO) shift registers, such as 74HC4094 or 74HC595. Those are commonly used to control segmented LED displays, LED matrices etc.

This unit handles both the *Shift* and *Store* signals and is capable of loading multiple shift registers simultaneously, reducing visible glitches in the display. It's also possible to set the data lines to arbitrary level(s) before sending the Store pulse, which can be latched and used for some additional feature of the LED display, such as brightness control.

12.4.1 SIPO Configuration

```
[SIPO:display@9]
# Shift pin & its active edge (1-rising,0-falling)
shift-pin=A1
shift-pol=1
# Store pin & its active edge
store-pin=A0
store-pol=1
# Clear pin & its active level
clear-pin=A2
clear-pol=0
# Data port and pins
data-port=A
data-pins=3
```

12.4.2 SIPO Commands

Code	Function	Structure
0	WRITE Load the shift registers and leave the data outputs in the “trailing data” state before sending the Store pulse.	<i>Request:</i> <ul style="list-style-type: none"> • u16 trailing data • For each output (same size) <ul style="list-style-type: none"> – u8[] data to load
1	DIRECT_DATA Directly write to the data pins (same like the DO unit’s WRITE command)	<i>Request:</i> <ul style="list-style-type: none"> • u16 values to write
2	DIRECT_CLEAR Pulse the Clear pin, erasing the registers’ data	
3	DIRECT_SHIFT Pulse the Shift pin	
4	DIRECT_STORE Pulse the Store pin	

12.5 NeoPixel Unit

The NeoPixel unit implements the protocol needed to control a digital **LED** strip with WS2812, WS2811, or compatible **LED** driver chips. The protocol timing is implemented in software, therefore it is available on any GPIO pin of the module.

The color data can be loaded in five different format: as packed bytes, or as the little-endian or big-endian encoding of colors in the 32-bit format 0x00RRGGBB or 0x00BBGRR.

This data format is convenient when the colors are already represented by an array of 32-bit integers.

12.5.1 NeoPixel Configuration

```
[NPX:neo@3]
# Data pin
pin=A0
# Number of pixels
pixels=32
```

12.5.2 NeoPixel Commands

Code	Function	Structure
0	CLEAR Switch all LEDs off (sets them to black)	
1	LOAD Load a sequence of R,G,B bytes	<i>Request:</i> <ul style="list-style-type: none"> For each LED: <ul style="list-style-type: none"> – u8 red – u8 green – u8 blue
4	LOAD_U32_ZRGB Load 32-bit big-endian 0xRRGGBB (0,R,G,B)	<i>Request:</i> <ul style="list-style-type: none"> • u32 [] color data BE
5	LOAD_U32_ZBGR Load 32-bit big-endian 0xBBGRR (0,B,G,R)	<i>Request:</i> <ul style="list-style-type: none"> • u32 [] color data BE
6	LOAD_U32_RGBZ Load 32-bit little-endian 0xBBGRR (R,G,B,0)	<i>Request:</i> <ul style="list-style-type: none"> • u32 [] color data LE
7	LOAD_U32_BGRZ Load 32-bit little-endian 0xRRGGBB (B,G,R,0)	<i>Request:</i> <ul style="list-style-type: none"> • u32 [] color data LE
10	GET_LEN Get number of LEDs in the strip	<i>Response:</i> <ul style="list-style-type: none"> • u16 number of LEDs

12.6 SPI Unit

The **SPI** unit provides access to one of the microcontroller's **SPI** peripherals. It can be configured to use any of the different speeds, clock polarity and phase settings available in its control registers.

The unit handles up to 16 slave select (**NSS**) signals and supports message multi-cast (addressing more than one slaves at once). Protection resistors should be used if a multi-cast transaction is issued with **MISO** connected.

The **QUERY** command of this unit, illustrated by figure 12.2, is flexible enough to support all types of **SPI** transactions: read-only, write-only, and read-write with different request and response lengths. The slave select pin is held low during the entire transaction.

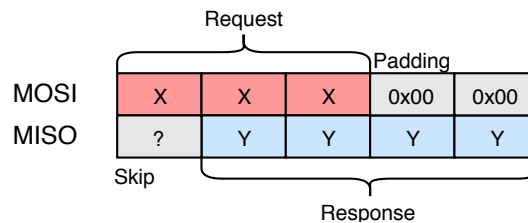

Figure 12.2: SPI transaction using the **QUERY** command

12.6.1 SPI Configuration

```
[SPI:spi05]
# Peripheral number (SPIx)
device=1
# Pin mappings (SCK,MISO,MOSI)
# SPI1: (0) A5,A6,A7      (1) B3,B4,B5
# SPI2: (0) B13,B14,B15
remap=0
# Prescaler: 2,4,8,...,256
prescaler=64
# Clock polarity: 0,1 (clock idle level)
cpol=0
# Clock phase: 0,1 (active edge, 0-first, 1-second)
cpha=0
# Transmit only, disable MISO
tx-only=N
# Bit order (LSB or MSB first)
first-bit=MSB
# SS port name
port=A
# SS pins (comma separated, supports ranges)
pins=0
```

12.6.2 SPI Commands

Code	Function	Structure
0	QUERY Exchange bytes with a slave device	<i>Request:</i> <ul style="list-style-type: none"> • u8 slave number 0–16 • u16 response padding • u16 response length • u8[] bytes to write <i>Response:</i> <ul style="list-style-type: none"> • u8[] received bytes
1	MULTICAST Send a message to multiple slaves at once. The address is a bit map (e.g. 0x8002 = slaves 1 and 15).	<i>Request:</i> <ul style="list-style-type: none"> • u16 addressed slaves • u8[] bytes to write

12.7 I²C Unit

The I²C unit provides access to one of the microcontroller's I²C peripherals. It can be configured to use either of the three speeds (Standard, Fast and Fast+) and supports both 10-bit and 7-bit addressing. 10-bit addresses can be used in commands by setting their highest bit (0x8000), as a flag to the unit.

12.7.1 I²C Configuration

```
[I2C:d@4]
# Peripheral number (I2Cx)
device=1
# Pin mappings (SCL,SDA)
# I2C1: (0) B6,B7 (1) B8,B9
# I2C2: (0) B10,B11 (1) B13,B14
remap=0

# Speed: 1-Standard, 2-Fast, 3-Fast+
speed=1
# Analog noise filter enable (Y,N)
analog-filter=Y
# Digital noise filter bandwidth (0-15)
digital-filter=0
```

12.7.2 I²C Commands

Code	Function	Structure
0	WRITE Raw write transaction	<i>Request:</i> <ul style="list-style-type: none"> • u16 slave address • u8[] bytes to write
1	READ Raw read transaction	<i>Request:</i> <ul style="list-style-type: none"> • u16 slave address • u16 number of read bytes <i>Response:</i> <ul style="list-style-type: none"> • u8[] received bytes
2	WRITE_REG Write to a slave register. Sends the register number and the data in the same I²C transaction. Multiple registers can be written to slaves supporting auto-increment.	<i>Request:</i> <ul style="list-style-type: none"> • u16 slave address • u8 register number • u8[] bytes to write
3	READ_REG Read from a slave register. Writes the register number and issues a read transaction of the given length. Multiple registers can be read from slaves supporting auto-increment.	<i>Request:</i> <ul style="list-style-type: none"> • u16 slave address • u8 register number • u16 number of read bytes <i>Response:</i> <ul style="list-style-type: none"> • u8[] received bytes

12.8 USART Unit

The **USART** unit provides access to one of the microcontroller's **USART** peripherals. All **USART** parameters can be configured to match the application's needs. The peripheral is capable of driving RS485 transceivers with the **Driver Enable (DE)** output for switching between reception and transmission.

The unit implements asynchronous reception and transmission using DMA and a circular buffer. Received data is sent to the host in asynchronous events when either half of the buffer is filled, or after a fixed timeout from the last received byte.

12.8.1 USART Configuration

```
[USART:ser@6]
# Peripheral number (UARTx 1-4)
device=1
# Pin mappings (TX,RX,CK,CTS,RTS/DE)
# USART1: (0) A9,A10,A8,A11,A12 (1) B6,B7,A8,A11,A12
# USART2: (0) A2,A3,A4,A0,A1 (1) A14,A15,A4,A0,A1
# USART3: (0) B10,B11,B12,B13,B14
```

```
# USART4: (0) A0,A1,C12,B7,A15    (1) C10,C11,C12,B7,A15
remap=0

# Baud rate in bps (eg. 9600)
baud-rate=115200
# Parity type (NONE, ODD, EVEN)
parity=NONE
# Number of stop bits (0.5, 1, 1.5, 2)
stop-bits=1
# Bit order (LSB or MSB first)
first-bit=LSB
# Word width (7,8,9) - including parity bit if used
word-width=8
# Enabled lines (RX,TX,RXTX)
direction=RXTX
# Hardware flow control (NONE, RTS, CTS, FULL)
hw-flow-control=NONE

# Generate serial clock (Y,N)
clock-output=N
# Clock polarity: 0,1
cpol=0
# Clock phase: 0,1
cpha=0

# Generate RS485 Driver Enable signal (Y,N) - uses RTS pin
de-output=N
# DE active level: 0,1
de-polarity=1
# DE assert time (0-31)
de-assert-time=8
# DE clear time (0-31)
de-clear-time=8
```

12.8.2 USART Events

Code	Function	Structure
0	DATA_RECEIVED Data was received on the serial port.	<i>Payload:</i> <ul style="list-style-type: none"> • <code>u8[]</code> received bytes

12.8.3 USART Commands

Code	Function	Structure
0	WRITE Add data to the transmit buffer. Sending is asynchronous, but the command may wait for free space in the DMA buffer.	<i>Request:</i> <ul style="list-style-type: none"> • <code>u8[]</code> bytes to write
1	WRITE_SYNC Add data to the transmit buffer and wait for the transmission to complete.	<i>Request:</i> <ul style="list-style-type: none"> • <code>u8[]</code> bytes to write

12.9 1-Wire Unit

The 1-Wire unit implements the Dallas Semiconductor's 1-Wire protocol, most commonly used to interface smart thermometers (DS18x20). The protocol is explained in section 7.4.

This unit implements the ROM Search algorithm that is used to find the ROM codes of all 1-Wire devices connected to the bus. The algorithm can find up to 32 devices in one run; more devices can be found by issuing the `SEARCH_CONTINUE` command.

Devices are addressed using their ROM codes, unique 64-bit (8-byte) identifiers that work as addresses. When only one device is connected, the value 0 may be used instead and the addressing will be skipped. Its ROM code may be recovered using the `READ_ADDR` command or by the search algorithm.

12.9.1 1-Wire Configuration

```
[1WIRE:ow07]
# Data pin
pin=A0
# Parasitic (bus-powered) mode
parasitic=N
```

12.9.2 1-Wire Commands

Code	Function	Structure
0	CHECK_PRESENCE Test if there are any devices attached to the bus.	<i>Response:</i> <ul style="list-style-type: none"> • <code>u8</code> presence detected (0, 1)
1	SEARCH_ADDR Start the search algorithm.	<i>Response:</i> <ul style="list-style-type: none"> • <code>u8</code> should continue (0, 1) • <code>u64[]</code> ROM codes

Code	Function	Structure
2	SEARCH_ALARM Start the search algorithm, finding only devices in an alarm state.	<i>Response:</i> <ul style="list-style-type: none"> • u8 should continue (0, 1) • u64 [] ROM codes
3	SEARCH_CONTINUE Continue a previously started search	<i>Response:</i> <ul style="list-style-type: none"> • u8 should continue (0, 1) • u64 [] ROM codes
4	READ_ADDR Read a device address (single device only)	<i>Response:</i> <ul style="list-style-type: none"> • u64 ROM code
10	WRITE Write bytes to a device.	<i>Request:</i> <ul style="list-style-type: none"> • u64 ROM code • u8 [] bytes to write
11	READ Write a request and read response.	<i>Request:</i> <ul style="list-style-type: none"> • u64 ROM code • u16 read length • u8 verify checksum (0, 1) • u8 [] request bytes <i>Response:</i> <ul style="list-style-type: none"> • u8 [] read bytes
20	POLL_FOR_1 Wait for a READY status, used by DS18x20. Not available in parasitic mode. Responds with SUCCESS after all devices are ready.	

12.10 Frequency Capture Unit

The frequency capture unit implements both the frequency measurement methods explained in section 8.1: direct and reciprocal.

The unit has several operational modes: idle, reciprocal continuous, reciprocal burst, direct continuous, direct burst, free counting, and single pulse. Burst mode is an on-demand measurement with possible averaging. Continuous mode doesn't support averaging, but the latest measurement can be read at any time without a delay.

12.10.1 Value Conversion Formulas

Several of the features implemented in this unit would require floating point arithmetic to provide the measured value in the desired units (Hz, seconds). That is not available in Cortex-M0, only as a software implementation. The calculation is left to the client in order

to save Flash space that would be otherwise used by the the arithmetic functions. This arrangement also avoids rounding errors and a possible loss of precision.

■ Reciprocal (Indirect) Measurement

Period (in seconds) is computed as:

$$T = \frac{\text{period_sum}}{f_{\text{core,MHz}} \cdot 10^6 \cdot \text{n_periods}}$$

The frequency is obtained by simply inverting it:

$$f = T^{-1}$$

The average duty cycle is computed as the ratio of the sum of active-level pulses and the sum of all periods:

$$\text{average_duty} = \frac{\text{ontime_sum}}{\text{period_sum}}$$

■ Direct Measurement

The frequency can be derived from the pulse count and measurement time using its definition (t_{ms} is measurement time in milliseconds):

$$f = \frac{1000 \cdot \text{count} \cdot \text{prescaller}}{t_{\text{ms}}}$$

■ 12.10.2 Frequency Capture Configuration

```
[FCAP:j@10]
# Signal input pin - one of:
# Full support: A0, A5, A15
# Indirect only: A1, B3
pin=A0

# Active level or edge (0-low,falling; 1-high,rising)
active-level=1
# Input filtering (0-15)
input-filter=0
# Pulse counter pre-divider (1,2,4,8)
direct-presc=1
# Pulse counting interval (ms)
direct-time=1000
```

```
# Mode on startup: N-none, I-indirect, D-direct, F-free count
initial-mode=N
```

12.10.3 Frequency Capture Commands

Some commands include optional parameter setting. Using 0 in the field keeps the previous value. Those fields are marked with *.

Code	Function	Structure
0	STOP Stop all measurements, go idle	
1	INDIRECT_CONT_START Start a repeated reciprocal measurement	
2	INDIRECT_BUTST_START Start a burst of reciprocal measurements	<i>Request:</i> <ul style="list-style-type: none"> • u16 number of periods <i>Response:</i> <ul style="list-style-type: none"> • u16 core speed (MHz) • u16 number of periods • u64 sum of all periods (ticks) • u16 sum of on-times (ticks)
3	DIRECT_CONT_START Start a repeated direct measurement	<i>Request:</i> <ul style="list-style-type: none"> • u16 *measurement time • u8 *prescaller (1, 2, 4, 8)
4	DIRECT_BURST_START Start a single direct measurement. Longer capture time may help increase accuracy for stable signals.	<i>Request:</i> <ul style="list-style-type: none"> • u16 *measurement time (ms) • u8 *prescaller (1, 2, 4, 8) <i>Response:</i> <ul style="list-style-type: none"> • u8 prescaller • u16 measurement time (ms) • u32 pulse count
5	FREECOUNT_START Clear and start the pulse counter	<i>Request:</i> <ul style="list-style-type: none"> • u8 *prescaller (1,2,4,8)
6	MEASURE_SINGLE_PULSE Measure a single pulse of the active level. Waits for a rising edge.	<i>Response:</i> <ul style="list-style-type: none"> • u16 core speed (MHz) • u32 pulse length (ticks)
7	FREECOUNT_CLEAR Read and clear the pulse counter.	<i>Response:</i> <ul style="list-style-type: none"> • u32 previous counter value

Code	Function	Structure
10	INDIRECT_CONT_READ Read the latest value from the continuous reciprocal measurement, if running.	<i>Response:</i> <ul style="list-style-type: none"> • u16 core speed (MHz) • u32 period length (ticks) • u32 on-time (ticks)
11	DIRECT_CONT_READ Read the latest value from the continuous direct measurement, if running.	<i>Response:</i> <ul style="list-style-type: none"> • u8 prescaller • u16 measurement time (ms) • u32 pulse count
12	FREECOUNT_READ Read the pulse counter value	<i>Response:</i> <ul style="list-style-type: none"> • u32 pulse count
20	SET_POLARITY Set pulse polarity (active level)	<i>Response:</i> <ul style="list-style-type: none"> • u8 polarity (0,1)
21	SET_PRESCALLER Set prescaller for the direct mode	<i>Response:</i> <ul style="list-style-type: none"> • u8 prescaller (1,2,4,8)
22	SET_INPUT_FILTER Set input filtering (a hardware feature designed to ignore glitches)	<i>Response:</i> <ul style="list-style-type: none"> • u8 filtering factor (0-15, 0=off)
23	SET_DIR_MSEC Set direct measurement time	<i>Response:</i> <ul style="list-style-type: none"> • u16 measurement time (ms)
30	RESTORE_DEFAULTS Restore all run-time adjustable parameters to their configured default values	

12.11 ADC Unit

The analog/digital converter unit is one of the most complicated units implemented in the project. The unit can measure the voltage on an input pin, either as its immediate value, or averaged with exponential forgetting. Isochronous sampling is available as well: It's possible to capture a fixed-length block of data on demand, or as a response to a triggering condition on any of the enabled input pins. The **ADC** must continuously sample the inputs to make the averaging and level based triggering possible; as a consequence, a pre-trigger buffer is available that can be read together with the block of samples following a trigger. The **ADC** unit can also be switched to a continuous streaming mode.

It's possible to activate any number of the 16 analog inputs of the **ADC** peripheral simultaneously. The maximum continuous sampling frequency, which reaches 70 kbps with one channel, lowers with an increasing number of enabled channels as the amount of data to transfer to the host increases.

12.11.1 ADC Configuration

```
[ADC:adc08]
# Enabled channels, comma separated
# 0 1 2 3 4 5 6 7 8 9 10 11 12 13 14 15 16 17
# A0 A1 A2 A3 A4 A5 A6 A7 B0 B1 C0 C1 C2 C3 C4 C5 Tsens Vref
channels=16

# Sampling time (0-7)
sample_time=2
# Sampling frequency (Hz)
frequency=1000

# Sample buffer size
# - shared by all enabled channels
# - defines the maximum pre-trigger size (divide by # of channels)
# - captured data is sent in half-buffer chunks
# - buffer overrun aborts the data capture
buffer_size=256

# Enable continuous sampling with averaging
# Caution: This can cause DAC output glitches
averaging=Y
# Exponential averaging coefficient (permil, range 0-1000 ~ 0.000-1.000)
# - used formula:  $y[t]=(1-k)*y[t-1]+k*u[t]$ 
# - not available when a capture is running
avg_factor=500
```

12.11.2 ADC Events

Code	Function	Structure
50	TRIGGERED The first event generated when a triggering condition occurs. The payload includes pre-trigger and the transaction continues with a sequence of CAPTURE events sharing the same frame ID. The serial number is incremented with each stream chunk and can be used to detect lost data frames.	<i>Payload:</i> <ul style="list-style-type: none"> • u32 pre-trigger length • u8 triggering edge (1-falling, 2-rising, 3-forced) • u8 stream serial number • u16[] pre-trigger data

Code	Function	Structure
51	CAPTURE_DATA A chunk of sampled data in a stream, block, or a triggered capture. More data will follow.	<i>Payload:</i> <ul style="list-style-type: none"> • u8 stream serial number • u16[] sample data
52	CAPTURE_END Indicates the end of a multi-part capture. The payload may be empty if there is no more data to send (e.g. a stream had to be unexpectedly closed).	<i>Payload:</i> <ul style="list-style-type: none"> • u8 stream serial number • u16[] sample data

12.11.3 ADC Commands

Code	Function	Structure
0	READ_RAW Get the last raw sample from enabled channels.	<i>Response:</i> <ul style="list-style-type: none"> • u16[] raw values 0–4095
1	READ_SMOOTHED Get the averaged values from enabled channels. Not available for high sample rates and when disabled.	<i>Response:</i> <ul style="list-style-type: none"> • float32[] smoothed values 0–4095
2	READ_CAL_CONSTANTS Read factory calibration constants from the MCU's ROM	<i>Response:</i> <ul style="list-style-type: none"> • u16 VREFINT_CAL (raw word) • u16 VREFINT_CAL_VADCREF (mV) • u16 TSENSE_CAL1 (raw word) • u16 TSENSE_CAL2 (raw word) • u16 TSENSE_CAL1_TEMP (°C) • u16 TSENSE_CAL2_TEMP (°C) • u16 TSENSE_CAL_VADCREF (mV)
10	GET_ENABLED_CHANNELS Get numbers of all enabled channels (0-based)	<i>Response:</i> <ul style="list-style-type: none"> • u8[] enabled channel numbers
11	GET_SAMPLE_RATE Get the current sample rate (in Hz)	<i>Response:</i> <ul style="list-style-type: none"> • u32 requested sample rate • float32 real sample rate

Code	Function	Structure
20	SETUP_TRIGGER Configure the triggering level and other trigger parameters. This command does <i>not</i> arm the trigger!	<i>Request:</i> <ul style="list-style-type: none"> • u8 source channel number • u16 triggering level • u8 active edge (1-falling, 2-rising, 3-any) • u32 pre-trigger sample count • u32 post-trigger sample count • u16 hold-off time (ms) • u8 auto re-arm (0,1)
21	ARM Arm the trigger for capture.	<i>Request:</i> <ul style="list-style-type: none"> • u8 auto re-arm (0, 1, 255-no change)
22	DISARM Dis-arm the trigger.	
23	ABORT Abort any ongoing capture and dis-arm the trigger.	
24	FORCE_TRIGGER Manually trip the trigger, as if the threshold level was reached.	
25	BLOCK_CAPTURE Capture a fixed-length sequence of samples.	<i>Request:</i> <ul style="list-style-type: none"> • u32 number of samples
26	STREAM_START Start a real-time stream of samples	
27	STREAM_STOP Stop an ongoing stream	
28	SET_SMOOTHING_FACTOR Set the smoothing factor ($\times 10^3$).	<i>Request:</i> <ul style="list-style-type: none"> • u16 smoothing factor 0-1000
29	SET_SAMPLE_RATE Set the sampling frequency.	<i>Request:</i> <ul style="list-style-type: none"> • u32 frequency in Hz
30	ENABLE_CHANNELS Select channels to sample. The channels must be configured in the unit settings.	<i>Request:</i> <ul style="list-style-type: none"> • u32 bit map of channels to enable
31	SET_SAMPLE_TIME Set the sample time of the ADC's sample&hold circuit.	<i>Request:</i> <ul style="list-style-type: none"> • u8 sample time 0–7

12.12 DAC Unit

The digital/analog unit works with the two-channel **DAC** peripheral of the microcontroller. It can be used in two modes: **DC** output, and waveform generation.

The waveform mode implements direct digital synthesis (explained in section 8.3.2) of a sine, rectangle, sawtooth or triangle wave. The generated frequency can be set with a sub-hertz precision up to the lower tens of kHz. The two outputs can use a different waveform shape, be synchronized, and their phase offset, as well as frequency, is dynamically adjustable.

12.12.1 DAC Configuration

```
[DAC:dac@13]
# Enabled channels (1:A4, 2:A5)
ch1_enable=Y
ch2_enable=Y
# Enable output buffer
ch1_buff=Y
ch2_buff=Y
# Superimposed noise type (NONE,WHITE,TRIANGLE) and nbr. of bits (1-12)
ch1_noise=NONE
ch1_noise-level=3
ch2_noise=NONE
ch2_noise-level=3
```

12.12.2 DAC Commands

Channels are specified in all commands as bit map:

- 0x01 - channel 1
- 0x02 - channel 2
- 0x03 - both channels affected at once

Code	Function	Structure
0	WAVE_DC Set a DC level, disable DDS for the channel	<i>Request:</i> <ul style="list-style-type: none"> • u8 channels • u16 level (0–4095)
1	WAVE_SINE Start a sine waveform	<i>Request:</i> <ul style="list-style-type: none"> • u8 channels
2	WAVE_TRIANGLE Start a symmetrical triangle waveform	<i>Request:</i> <ul style="list-style-type: none"> • u8 channels

Code	Function	Structure
3	WAVE_SAWTOOTH_UP Start a rising sawtooth waveform	<i>Request:</i> • u8 channels
4	WAVE_SAWTOOTH_DOWN Start a falling sawtooth waveform	<i>Request:</i> • u8 channels
5	WAVE_RECTANGLE Start a rectangle waveform	<i>Request:</i> • u8 channels • u16 on-time (0–8191) • u16 high level (0–4095) • u16 low level (0–4095)
10	SYNC Synchronize the two channels. The phase accumulator is reset to zero.	
20	SET_FREQUENCY Set the channel frequency	<i>Request:</i> • u8 channels • float32 frequency
21	SET_PHASE Set a channel's phase. It's recommended to set the phase only of one channel, leaving the other at 0°.	<i>Request:</i> • u8 channels • u16 phase (0–8191)
22	SET_DITHER Control the dithering function of the DAC block. A high noise amplitude can cause an overflow to the other end of the output range due to a bug in the DAC peripheral. Use value 255 to leave the parameter unchanged.	<i>Request:</i> • u8 channels • u8 noise type (0-none, 1-white, 2-triangle) • u8 number of noise bits (1–12)

12.13 PWM Unit

The **PWM** unit uses a timer/counter to generate a **PWM** signal. There are four outputs with a common frequency and phase, but independent duty cycles. Each channel can be individually enabled or disabled.

This unit is intended for applications like light dimming, heater regulation, or the control of H-bridges.

diagram, also show what is duty cycle

12.13.1 PWM Configuration

```
[PWMDIM:pwm@12]
# Default pulse frequency (Hz)
frequency=1000
# Pin mapping - 0=disabled
# Channel1 - 1:PA6, 2:PB4, 3:PC6
ch1_pin=1
# Channel2 - 1:PA7, 2:PB5, 3:PC7
ch2_pin=0
# Channel3 - 1:PB0, 2:PC8
ch3_pin=0
# Channel4 - 1:PB1, 2:PC9
ch4_pin=0
```

12.13.2 PWM Commands

Code	Function	Structure
0	SET_FREQUENCY Set the PWM frequency	<i>Request:</i> <ul style="list-style-type: none"> • u32 frequency in Hz
1	SET_DUTY Set the duty cycle of one or more channels	<i>Request:</i> <ul style="list-style-type: none"> • Repeat 1–4 times: <ul style="list-style-type: none"> – u8 channel number 0–3 – u16 duty cycle 0–1000
2	STOP Stop the hardware timer. Outputs enter low level.	
3	START Start the hardware timer.	

12.14 Touch Sense Unit

The touch sensing unit provides an access to the **TSC** peripheral. Its function is explained in section 8.4. The unit configures the **TSC** and reads the output values of each enabled touch pad.

12.14.1 Touch Sense Configuration

```
[TOUCH:touch@11]
# Pulse generator clock prescaller (1,2,4,...,128)
pg-clock-prediv=32
```

```

# Sense pad charging time (1-16)
charge-time=2
# Charge transfer time (1-16)
drain-time=2
# Measurement timeout (1-7)
sense-timeout=7

# Spread spectrum max deviation (0-128,0=off)
ss-deviation=0
# Spreading clock prescaler (1,2)
ss-clock-prediv=1

# Optimize for interlaced pads (individual sampling with others floating)
interlaced-pads=N

# Button mode debounce (ms) and release hysteresis (lsb)
btn-debounce=20
btn-hysteresis=10

# Each used group must have 1 sampling capacitor and 1-3 channels.
# Channels are numbered 1,2,3,4

# Group1 - 1:A0, 2:A1, 3:A2, 4:A3
g1_cap=
g1_ch=
# Group2 - 1:A4, 2:A5, 3:A6, 4:A7
g2_cap=
g2_ch=
# ...

```

12.14.2 Touch Sense Events

Code	Function	Structure
0	BUTTON_CHANGE The binary state of some of the capacitive pads with button mode enabled changed.	<i>Payload:</i> <ul style="list-style-type: none"> • u32 binary state of all channels • u32 changed / trigger-generating channels

12.14.3 Touch Sense Commands

Code	Function	Structure
0	READ Read the raw touch pad values (lower indicates higher capacitance). Values are ordered by group and channel.	<i>Request:</i> <ul style="list-style-type: none"> • u16[] raw values
1	SET_BIN_THR Set the button mode thresholds for all channels. Value 0 disables the button mode for a channel.	<i>Request:</i> <ul style="list-style-type: none"> • u16[] thresholds
2	DISABLE_ALL_REPORTS Set thresholds to 0, disabling the button mode for all pads.	
3	SET_DEBOUNCE_TIME Set the button mode debounce time (used for all pads with button mode enabled).	<i>Request:</i> <ul style="list-style-type: none"> • u16 debounce time (ms)
4	SET_HYSTERESIS Set the button mode hysteresis.	<i>Request:</i> <ul style="list-style-type: none"> • u16 hystheresis



Part IV

Results



Chapter 13

Conclusion

bla



Appendices

Appendix A

Bibliography

- [1] Seeed Technology Co.,Ltd. *Bus Pirate v4 product page*. URL: <https://www.seeedstudio.com/Bus-Pirate-v4-p-740.html> (visited on 05/12/2018).
- [2] National Instruments. *I²C/SPI Interface Device product page*. URL: <https://www.ni.com/en-gb/shop/select/i2c-spi-interface-device> (visited on 05/12/2018).
- [3] National Instruments. *USB-6008 product page*. URL: <http://www.ni.com/en-gb/support/model.usb-6008.html> (visited on 05/12/2018).
- [4] Total Phase, Inc. *USB-6008 product page*. URL: <https://www.totalphase.com/products/aardvark-i2cspi/> (visited on 05/12/2018).
- [5] USB Implementers Forum, Inc. *Universal Serial Bus Specification*. 2000. URL: http://www.usb.org/developers/docs/usb20_docs/ (visited on 05/12/2018).
- [6] Craig Peacock. *USB in a NutShell*. URL: <https://www.beyondlogic.org/usbnutshell> (visited on 05/12/2018).
- [7] MQP Electronics Ltd. *USB Made Simple*. 2008. URL: <http://www.usbmadesimple.co.uk/> (visited on 05/12/2018).
- [8] Microsoft Corporation. *Windows 2000 Professional Resource Kit / USB Functions*. 2008. URL: [https://docs.microsoft.com/en-us/previous-versions/windows/it-pro/windows-2000-server/cc939102\(v%3dtechnet.10\)](https://docs.microsoft.com/en-us/previous-versions/windows/it-pro/windows-2000-server/cc939102(v%3dtechnet.10)) (visited on 05/12/2018).
- [9] USB Implementers Forum, Inc. *USB Class Codes*. 2016. URL: http://www.usb.org/developers/defined_class (visited on 05/12/2018).
- [10] *pid.codes, a registry of USB PID codes for open source hardware projects*. URL: <http://pid.codes/> (visited on 05/12/2018).
- [11] EEVblog Electronics Community Forum. *pid.codes, a registry of USB PID codes for open source hardware projects*. URL: <https://www.eevblog.com/forum/projects/driving-the-1k5-usb-pull-up-resistor-on-d/> (visited on 05/12/2018).
- [12] USB Implementers Forum, Inc. *USB Mass Storage Class, Specification Overview*. 2010. URL: http://www.usb.org/developers/docs/devclass_docs/Mass_Storage_Specification_Overview_v1.4_2-19-2010.pdf (visited on 05/12/2018).
- [13] USB Implementers Forum, Inc. *USB Mass Storage Class, Bulk-Only Transport*. 1999. URL: http://www.usb.org/developers/docs/devclass_docs/usbmssbulk_10.pdf (visited on 05/12/2018).

- [14] *Discussion in a USB storage driver development mailing list (site defunct, archived via Archive.org)*. 2004. URL: <https://web.archive.org/web/20071108121822/https://lists.one-eyed-alien.net/pipermail/usb-storage/2004-September/000795.html> (visited on 05/12/2018).
- [15] Jan Axelson. *Mass Storage FAQ*. 2013. URL: http://janaxelson.com/mass_storage_faq.htm (visited on 05/12/2018).
- [16] USB Implementers Forum, Inc. *Class definitions for Communication Devices 1.2*. 2010. URL: http://www.usb.org/developers/docs/devclass_docs/CDC1.2_WMC1.1_012011.zip (visited on 05/12/2018).
- [17] USB Implementers Forum, Inc. *USB Interface Association Descriptor, Device Class Code and Use Model*. 2003. URL: http://www.usb.org/developers/docs/whitepapers/iadclasscode_r10.pdf (visited on 05/12/2018).
- [18] Real Time Engineers Ltd. *FreeRTOS Ports*. URL: <https://www.freertos.org/a00090.html> (visited on 05/12/2018).
- [19] Real Time Engineers Ltd. *The FreeRTOS™ Reference Manual*. Real Time Engineers Ltd., 2018. URL: https://www.freertos.org/Documentation/FreeRTOS_Reference_Manual_V10.0.0.pdf (visited on 05/12/2018).
- [20] Richard Barry. *Mastering the FreeRTOS™ Real Time Kernel. A Hands-On Tutorial Guide*. Real Time Engineers Ltd., 2016. URL: https://www.freertos.org/Documentation/161204_Mastering_the_FreeRTOS_Real_Time_Kernel-A_Hands-On_Tutorial_Guide.pdf (visited on 05/12/2018).
- [21] Real Time Engineers Ltd. *How FreeRTOS Works: FreeRTOS Implementation*. URL: <https://www.freertos.org/implementation/main.html> (visited on 05/12/2018).
- [22] Real Time Engineers Ltd. *FreeRTOS Stack Usage and Stack Overflow Checking*. URL: <https://www.freertos.org/Stacks-and-stack-overflow-checking.html> (visited on 05/12/2018).
- [23] Wikipedia contributors. *Comparison of File Systems / OS Support*. URL: https://en.wikipedia.org/wiki/Comparison_of_file_systems#OS_support (visited on 05/12/2018).
- [24] Microsoft Corporation. *How FAT Works*. 2009. URL: [https://docs.microsoft.com/en-us/previous-versions/windows/it-pro/windows-server-2003/cc776720\(v=ws.10\)](https://docs.microsoft.com/en-us/previous-versions/windows/it-pro/windows-server-2003/cc776720(v=ws.10)) (visited on 05/12/2018).
- [25] Jack Dobiash. *FAT16 Structure Information*. 1999. URL: <http://home.teleport.com/~brainy/fat16.htm> (visited on 05/12/2018).
- [26] LKT Software. *FAT16 File System*. 1999. URL: http://www.maverick-os.dk/FileSystemFormats/FAT16_FileSystem.html (visited on 05/12/2018).
- [27] Bob Eager. *A tutorial on the FAT file system*. 2017. URL: <http://www.tavi.co.uk/phobos/fat.html> (visited on 05/12/2018).
- [28] Microsoft Corporation. *FAT: General Overview of On-Disk Format*. Tech. rep. 2000. URL: <https://staff.washington.edu/dittrich/misc/fatgen103.pdf> (visited on 05/12/2018).

- [29] “vinDaci”. *Long Filename Specification*. 1998. URL: <http://home.teleport.com/~brainy/lfm.htm> (visited on 05/12/2018).
- [30] Arm Mbed. *Arm Mbed DAPLink source code repository*. 2018. URL: <https://github.com/ARMmbed/DAPLink> (visited on 05/12/2018).
- [31] “nkcelectronics”. *Retrofitting AutoReset feature into an old Arduino serial board*. URL: <https://playground.arduino.cc/Learning/AutoResetRetrofit> (visited on 05/13/2018).
- [32] SD Group. *SD Specifications, Part 1: Physical Layer Simplified Specification*. Tech. rep. 2010. URL: https://www.cs.utexas.edu/~simon/395t_os/resources/Part_1_Physical_Layer_Simplified_Specification_Ver_3.01_Final_100518.pdf (visited on 05/13/2018).
- [33] NXP Semiconductors. *I2C-bus specification and user manual*. 2014. URL: <https://www.nxp.com/docs/en/user-guide/UM10204.pdf> (visited on 05/12/2018).
- [34] Jared Becker Jonathan Valdez. *Understanding the I2C Bus*. Tech. rep. 2015. URL: <http://www.ti.com/lit/an/slva704/slva704.pdf> (visited on 05/12/2018).
- [35] Dallas Semiconductor. *AN214: Using a UART to Implement a 1-Wire Bus Master*. Tech. rep. URL: <https://www.maximintegrated.com/en/app-notes/index.mvp/id/214> (visited on 05/13/2018).
- [36] Dallas Semiconductor. *DS18S20 High Precision 1-Wire Digital Thermometer*. Tech. rep. URL: <https://datasheets.maximintegrated.com/en/ds/DS18S20.pdf> (visited on 05/13/2018).
- [37] Dallas Semiconductor. *AN162: Interfacing the DS18X20/DS1822 1-Wire Temperature Sensor in a Micro-controller Environment*. Tech. rep. URL: <https://www.maximintegrated.com/en/app-notes/index.mvp/id/162> (visited on 05/13/2018).
- [38] Worldsemi. *WS2812B datasheet*. Tech. rep. URL: www.world-semi.com/DownloadFile/108 (visited on 05/13/2018).
- [39] SiTime Corporation. *AN10033: Frequency Measurement Guidelines for Oscillators*. Tech. rep. URL: <https://www.sitime.com/api/gated/AN10033-Frequency-Measurement-Guidelines-for-Oscillators.pdf> (visited on 05/13/2018).
- [40] Paul Boven. “Increasing the resolution of reciprocal frequency counters”. In: *Proceedings of the 50. VHF meeting in Weinheim*. URL: <https://www.febo.com/pipermail/time-nuts/attachments/20071201/e7833af5/attachment.pdf> (visited on 05/13/2018).
- [41] Maxim Integrated. *AN1080: Understanding SAR ADCs: Their Architecture and Comparison with Other ADCs*. Tech. rep. 2001. URL: <https://pdfserv.maximintegrated.com/en/an/AN1080.pdf> (visited on 05/13/2018).
- [42] Eva Murphy and Colm Slattery. “All about direct digital synthesis”. In: *Ask The Application Engineer* 33 (2004). URL: <http://www.analog.com/media/en/analog-dialogue/volume-38/number-3/articles/all-about-direct-digital-synthesis.pdf>.
- [43] ST Microelectronics. *RM0091: STM32F0x1/STM32F0x2/STM32F0x8 reference manual*. 2017. URL: http://www.st.com/resource/en/reference_manual/dm00031936.pdf (visited on 05/12/2018).

- [44] ST Microelectronics. *STM32L4 training: Touch Sensing Controller*. Tech. rep. 2017. URL: http://www.st.com/resource/en/product_training/stm32l4_peripheral_touchsense.pdf (visited on 05/12/2018).
- [45] ST Microelectronics. *Touch Sensing Controller (TSC) presentation*. Tech. rep. 2015. URL: <https://wenku.baidu.com/view/8472044a6137ee06eef9180c.html?re=view> (visited on 05/12/2018).
- [46] ST Microelectronics. *AN4299: Guidelines to improve conducted noise robustness on STM32F0 Series, STM32F3 Series, STM32L0 Series and STM32L4 Series touch sensing applications*. Tech. rep. 2018. URL: http://www.st.com/resource/en/application_note/dm00085385.pdf (visited on 05/12/2018).
- [47] ST Microelectronics. *AN4310: Sampling capacitor selection guide for MCU based touch sensing applications*. Tech. rep. 2015. URL: http://www.st.com/resource/en/application_note/dm00087593.pdf (visited on 05/12/2018).
- [48] ST Microelectronics. *AN4312: Guidelines for designing touch sensing applications with surface sensors*. Tech. rep. 2017. URL: http://www.st.com/resource/en/application_note/dm00087990.pdf (visited on 05/12/2018).
- [49] ST Microelectronics. *AN4316: Tuning a STMTouch-based application*. Tech. rep. 2015. URL: http://www.st.com/resource/en/application_note/dm00088471.pdf (visited on 05/12/2018).
- [50] Hruška, Ondřej. *TinyFrame, a library for building and parsing data frames for serial interfaces*. URL: <https://github.com/MightyPork/TinyFrame> (visited on 05/13/2018).
- [51] Semtech Corporation. *SX1276/77/78/79 datasheet*. 2016. URL: https://www.semtech.com/uploads/documents/DS_SX1276-7-8-9_W_APP_V5.pdf (visited on 05/12/2018).
- [52] Nordic Semiconductor. *nRF24L01+ Single Chip 2.4GHz Transceiver Product Specification v1.0*. 2008. URL: http://www.nordicsemi.com/eng/content/download/2726/34069/file/nRF24L01P_Product_Specification_1_0.pdf (visited on 05/12/2018).