

**Master Thesis**

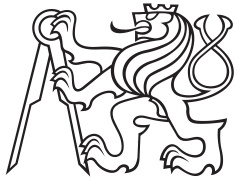

**Czech  
Technical  
University  
in Prague**

**F3**

**Faculty of Electrical Engineering  
Department of Measurement**

## **Learning and automation GPIO platform**

**Ondřej Hruška**

**Supervisor: doc. Ing. Radislav Šmíd, Ph.D.  
Field of study: Cybernetics and Robotics  
Subfield: Sensors and Instrumentation  
2018**





# MASTER'S THESIS ASSIGNMENT

## I. Personal and study details

Student's name: **Hruška Ondřej** Personal ID number: **420010**  
Faculty / Institute: **Faculty of Electrical Engineering**  
Department / Institute: **Department of Measurement**  
Study program: **Cybernetics and Robotics**  
Branch of study: **Sensors and Instrumentation**

## II. Master's thesis details

Master's thesis title in English:

**Learning and Automation GPIO Platform**

Master's thesis title in Czech:

**Výuková a automatizační GPIO platforma**

Guidelines:

Design and implement a modular system consisting of a motherboard and additional modules for connecting sensors, actuators and general inputs via I2C, SPI, UART, 1-Wire or other interfaces to the central system via USB, UART, and wireless interfaces. Allow access to built-in processor peripherals such as ADC, DAC, and timers (PWM, frequency measurement). Design a comfortable way to set the configuration without firmware changes. For the designed system, create a service library in C, Python, and MATLAB.

Bibliography / sources:

- [1] STMicroelectronics datasheets, <http://www.st.com>
- [2] Ganssle, J.: The Art of Designing Embedded Systems, Elsevier Science, 2008.
- [3] Chi, Qingping & Yan, Hairong & Zhang, Chuan & Pang, Zhibo & Da Xu, Li. (2014).: A Reconfigurable Smart Sensor Interface for Industrial WSN in IoT Environment. Industrial Informatics, IEEE Transactions on. 10. 1417-1425. 10.1109/TII.2014.2306798.

Name and workplace of master's thesis supervisor:

**doc. Ing. Radislav Šmíd, Ph.D., Department of Measurement, FEL**

Name and workplace of second master's thesis supervisor or consultant:

Date of master's thesis assignment: **10.01.2018** Deadline for master's thesis submission: \_\_\_\_\_

Assignment valid until:  
**by the end of summer semester 2018/2019**

\_\_\_\_\_  
doc. Ing. Radislav Šmíd, Ph.D.  
Supervisor's signature

\_\_\_\_\_  
Head of department's signature

\_\_\_\_\_  
prof. Ing. Pavel Ripka, CSc.  
Dean's signature

## III. Assignment receipt

The student acknowledges that the master's thesis is an individual work. The student must produce his thesis without the assistance of others, with the exception of provided consultations. Within the master's thesis, the author must state the names of consultants and include a list of references.

\_\_\_\_\_  
Date of assignment receipt

\_\_\_\_\_  
Student's signature



## Declaration

Prohlašuji, že jsem předloženou práci vypracoval samostatně a že jsem uvedl veškeré použité informační zdroje v souladu s Metodickým pokynem o dodržování etických principů při přípravě vysokoškolských závěrečných prací.

V Praze, 27. května 2018

.....

## Acknowledgements

blabla

## Abstract

This thesis documents the development of a general purpose software and hardware platform for interfacing low level hardware from high level programming languages and applications run on a PC, using USB and also wirelessly.

The requirements of common engineering tasks and problems occurring in the university environment were evaluated to design an extensible, reconfigurable hardware module that would make a practical, versatile, and low cost tool that in some cases also eliminates the need for professional measurement and testing equipment.

Several hardware prototypes and control libraries in programming languages C and Python have been developed. The Python library additionally integrates with MATLAB scripts. The devices provide access to a range of hardware buses and low level features and can be reconfigured using configuration files stored inside its permanent memory.

### Keywords:

**Supervisor:** doc. Ing. Radislav Šmíd, Ph.D.

## Abstrakt

Tato práce popisuje vývoj univerzální softwarové a hardwarové platformy pro přístup k hardwarovým sběrnicím a elektrickým obvodům z prostředí vysokoúrovňových programovacích jazyků a aplikací běžících na PC, a to za využití USB a také bezdrátově.

Byly vyhodnoceny požadavky typických problémů, vyskytujících se v praxi při práci s vestavěnými systémy a ve výuce, pro návrh snadno rozšiřitelného a přenastavitelného hardwarového modulu který bude praktickým, pohodlným a dostupným nástrojem který navíc v některých případech může nahradit profesionální laboratorní přístroje.

Bylo navrženo několik prototypů hardwarových modulů, spolu s obslužnými knihovnami v jazycích C a Python; k modulu lze také přistupovat z prostředí MATLAB. Přístroj umožňuje přístup k většině běžných hardwarových sběrnic a umožňuje také např. měřit frekvenci a vzorkovat či generovat analogové signály.

### Klíčová slova:

**Překlad názvu:** Výuková a automatizační GPIO platforma

# Contents

## Part I Introduction

<b>1 Motivation</b>	<b>3</b>
1.1 The Project's Expected Outcome	4
<b>2 Requirement Analysis</b>	<b>7</b>
2.0.1 Interfacing Intelligent Modules	7
2.0.2 Analog Signal Acquisition	7
2.0.3 Analog Signal Output	8
2.0.4 Logic Level Input and Output	8
2.0.5 Pulse Generation and Measurement	8
2.1 Connection to the Host Computer	8
2.1.1 Messaging	8
2.1.2 Configuration Files	9
2.2 Planned Feature List	9
2.3 Microcontroller Selection	10
2.4 Form Factor Considerations	10
<b>3 Existing Solutions</b>	<b>13</b>
3.1 Bus Pirate	13
3.2 Raspberry Pi	14
3.3 Professional DAQ Modules	14
3.4 The Firmata Protocol	15

## Part II Theoretical Background

<b>4 Universal Serial Bus</b>	<b>19</b>
4.1 Basic Principles and Terminology	20
4.2 USB Physical Layer	23
4.3 USB Classes	23
4.3.1 Mass Storage Class	24
4.3.2 CDC/ACM Class	24
4.3.3 Interface Association: Composite Class	25



<b>5 FreeRTOS</b>	<b>27</b>
5.1 Basic FreeRTOS Concepts and Functions	27
5.1.1 Tasks	27
5.1.2 Synchronization Objects	28
<b>6 The FAT16 File System and Its Emulation</b>	<b>29</b>
6.1 The General Structure of the FAT File System	29
6.1.1 Boot Sector	30
6.1.2 File Allocation Table	30
6.1.3 Root Directory	30
6.2 FAT16 Emulation	32
6.2.1 Handling a Read Access	32
6.2.2 Handling a Write Access	33
6.2.3 File Name Change	33
6.2.4 File Creation	33
6.2.5 File Content Change	34
<b>7 Supported Hardware Buses</b>	<b>35</b>
7.1 UART and USART	35
7.1.1 Examples of Devices Using UART	35
7.2 SPI	36
7.2.1 Examples of Devices Using SPI	36
7.3 I2C	37
7.3.1 Examples of Devices Using I2C	38
7.4 1-Wire	38
7.4.1 Examples of Devices Using 1-Wire	39
7.5 NeoPixel	39
<b>8 Additional Hardware Functions</b>	<b>43</b>
8.1 Frequency Measurement	43
8.2 Analog Signal Acquisition	45
8.3 Waveform Generation	45
8.3.1 Waveform Generation with DMA and a Timer	45

8.3.2 Direct Digital Synthesis .....	46
8.4 Touch Sensing .....	47

### Part III Implementation

<b>9 Application Structure</b>	<b>53</b>
9.1 User's View of GEX .....	53
9.2 Functions of the Core Framework .....	54
9.3 Resource Allocation .....	55
9.4 Settings Storage .....	55
9.5 Functional Blocks .....	56
9.6 Source Code Layout .....	57
9.7 Communication Ports .....	57
9.7.1 USB Connection .....	58
9.7.2 Communication UART .....	58
9.7.3 Wireless Connection .....	58
9.8 Message Passing .....	58
9.9 Interrupt Routing .....	59
<b>10 Communication Protocol</b>	<b>61</b>
10.1 Frame Structure .....	61
10.2 Message Listeners .....	62
10.3 Designated Frame Types in GEX .....	62
10.4 Bulk Read and Write Transactions .....	63
10.4.1 Bulk Read .....	63
10.4.2 Bulk Write .....	64
10.4.3 Persisting the Changed Configuration to Flash .....	64
10.5 Reading a List of Units .....	65
10.6 Unit Requests and Reports .....	65
10.6.1 Unit Requests .....	65
10.6.2 Unit Reports .....	66
<b>11 Wireless Interface</b>	<b>67</b>
11.1 Comparing SX1276 vs. nRF24L01+ .....	67

11.2 Integration of the nRF24L01+ into GEX .....	68
11.2.1 The Wireless Gateway Protocol.....	69
<b>12 Units Overview and API</b> .....	<b>71</b>
12.1 Naming Conventions and Common Principles .....	71
12.1.1 Unit Naming .....	71
12.1.2 Packed Pin Access .....	71
12.2 DO: Digital Output .....	72
12.2.1 DO Configuration.....	72
12.2.2 DO Events.....	72
12.2.3 DO Commands .....	73
12.3 DI: Digital Input .....	73
12.3.1 DI Configuration .....	73
12.3.2 DI Events.....	74
12.3.3 DI Commands.....	74
12.4 SIPO: Shift Registers Driver .....	74
12.4.1 SIPO Configuration .....	75
12.4.2 SIPO Events .....	75
12.4.3 SIPO Commands .....	75
12.5 NPX: NeoPixel .....	75
12.5.1 NPX Configuration .....	76
12.5.2 NPX Events .....	76
12.5.3 NPX Commands.....	76
12.6 SPI Unit .....	77
12.6.1 SPI Configuration .....	77
12.6.2 SPI Events.....	78
12.6.3 SPI Commands .....	78
12.7 I2C Unit .....	78
12.7.1 I2C Configuration .....	78
12.7.2 I2C Events.....	79
12.7.3 I2C Commands .....	79
12.8 USART Unit .....	79

12.9 1-Wire Unit .....	79
12.10 Frequency Capture Unit .....	80
12.11 ADC Unit .....	80
12.12 DAC Unit .....	80
12.13 PWM Unit .....	80
12.14 Touch Sensing Unit .....	81

## **Appendices**

## Figures

1.1 A collection of intelligent sensors and devices . . . . .	3
1.2 An early sketch of a universal bench device . . . . .	4
2.1 A Discovery board with STM32F072 . . . . .	11
2.2 Form factor sketches . . . . .	11
3.1 Bus Pirate v.4 (picture by <i>Seeed Studio</i> ) . . . . .	13
3.2 Raspberry Pi 2 (picture by <i>Raspberry Pi Foundation</i> ) . . . . .	14
3.3 Professional tools that GEX can replace . . . . .	15
4.1 USB hierarchical structure . . . . .	19
4.2 A detailed view of the host-device connection ( <i>USB specification rev. 1.1</i> ) . . . . .	20
4.3 USB descriptors of a GEX prototype obtained using <code>lsusb -vd vid:pid</code> . . . . .	22
4.4 NRZI encoding example . . . . .	23
4.5 USB pull-ups. . . . .	24
6.1 An example of the GEX virtual file system. . . . .	31
7.1 UART frame structure . . . . .	36
7.2 SPI master with multiple slaves . . . . .	37
7.3 I2C message diagram . . . . .	39
7.4 1-Wire topology (by <i>Dallas Semiconductor</i> ) . . . . .	39
7.5 The 1-Wire DIO pulse timing (by <i>Dallas Semiconductor</i> ) . . . . .	40
7.6 A close-up photo of the WS2812B package, showing the LED driver IC . . . . .	41
7.7 NeoPixel pulse timing diagram and time constraints table ( <i>WS2812 datasheet</i> ) . . . . .	41
8.1 Direct frequency measurement method . . . . .	44
8.2 Reciprocal frequency measurement method. . . . .	44
8.3 Frequency measurement methods comparison. . . . .	45
8.4 A simple implementation of the waveform generator . . . . .	46
8.5 A block diagram of a direct digital synthesis waveform generator. . . . .	47
8.6 The touch slider on a STM32F072 Discovery board . . . . .	48

8.7 A voltage waveform measured on the touch sensing pad. The bottom side of the envelope equals the sampling capacitor’s voltage—this is the phase where both capacitors are connected. The detailed view (middle) shows the individual charging cycles. The bottom screenshot captures the entire waveform after the analog comparator was disabled. ....	49
9.1 An example allocation in the resource registry .....	55
9.2 Structure of the settings subsystem .....	56
9.3 The general structure of the source code repository .....	57
10.1 A diagram of the bulk read and write transaction. ....	64
11.1 Test setup with a GEX prototype controlling two nRF24L01+ modules .....	67
11.2 A block diagram of the wireless connection .....	69
12.1 Pin packing .....	71
12.2 SPI transaction using the QUERY command .....	77



**Part I**

**Introduction**





# Chapter 1

## Motivation

Prototyping, design evaluation and the measurement of physical properties in experiments make a daily occurrence in the engineering praxis. Those tasks typically involve the generation and sampling of electrical signals coming to and from sensors, actuators, and other circuitry.

In the recent years a wide range of intelligent sensors became available thanks to the drive for miniaturization in the consumer electronics industry. Those devices often provide a sufficient accuracy and precision while keeping the circuit complexity and cost low. In contrast to analog sensors, here the signal conditioning and processing circuits are built into the sensor itself and we access it using a digital connection.

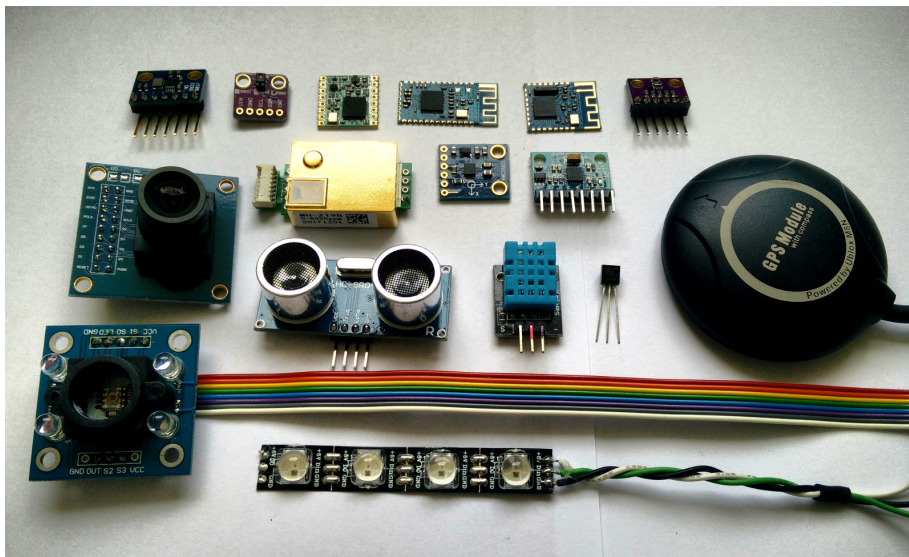

**Figure 1.1:** A collection of intelligent sensors and devices, most on breadboard adapters: (from top left) a waveform generator, a gesture detector, a LoRa and two Bluetooth modules, an air quality and pressure sensor, a CO<sub>2</sub> sensor, a digital compass, an accelerometer, a GPS module, a camera, an ultrasonic range finder, a humidity sensor, a 1-Wire thermometer, a color detector and an RGB LED strip.

To conduct experiments with those integrated modules, or even just familiarize ourselves with a device before using it in a project, we need a way to easily interact with them. It's also convenient to have a direct access to hardware, be it analog signal sampling, generation, or even just logic level inputs and outputs. However, the drive for miniaturization and

the advent of USB (Universal Serial Bus) led to the disappearance of low level computer ports, such as the printer port (LPT), that would provide an easy way of doing so.

Today, when one wants to perform measurements using a digital sensor, the usual route is to implement an embedded firmware for a microcontroller that connects to the PC through USB, or perhaps just shows the results on a display. This approach has its advantages, but is time-consuming and requires knowledge entirely unrelated to the measurements we wish to perform. It would be advantageous to have a way to interface hardware without having to burden ourselves with the technicalities of the connection, even at the cost of lower performance compared to a specialized device or a professional tool.

The design and implementation of such a universal instrument is the object of this work. For technical reasons, such as naming the source code repositories, we need a name for the project; it'll be hereafter called *GEX*, a name originating from "GPIO Expander".

## 1.1 The Project's Expected Outcome

It's been a desire of the author to create an universal instrument connecting low level hardware to a computer for many years, and with this project it is finally being realized. Several related projects approaching this problem from different angles can be found on the internet; those will be presented in chapter 3. This project should not end with yet another tinkering tool that will be produced in a few prototypes and then forgotten. By building an extensible, open-source platform, GEX can become the foundation for future projects which others can expand, re-use and adapt to their specific needs.

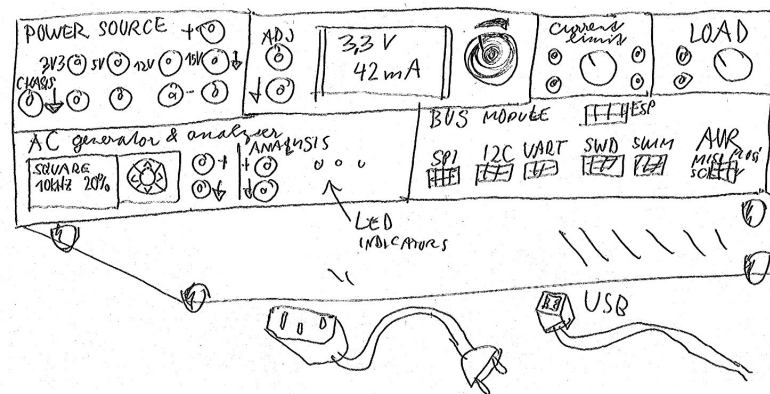

**Figure 1.2:** An early (2016) sketch of a universal bench device including a power supply, electronic load, a signal generator and a bus module. The bottom half of the panel is in a large part implemented by GEX.

Building on the experience with earlier embedded projects, a STM32 microcontroller shall be used. Those are ARM Cortex M devices with a wide range of hardware peripherals that appear to be a good fit for the project. Low-cost evaluation boards are widely available that could be used as a hardware platform instead of developing a custom PCB. In addition, those chips are relatively cheap and popular in the embedded hardware community; there's

a good possibility of the project building a community around it and growing beyond what will be presented in this paper.

Besides the use of existing development boards, custom PCBs will be developed in different form factors. Those could use the Arduino connector or the Raspberry Pi Zero GPIO header (and board shape) to exploit the cases and boxes available for the minicomputer on the market, as well as add-on boards (*shields* and *HATs*).

The possibilities of wireless connection should be evaluated. This feature should make GEX useful e.g. in mobile robotics or when installed in poorly accessible locations.



## Chapter 2

### Requirement Analysis

We'll now investigate some situations where GEX could be used, to establish its requirements and desired features.

#### 2.0.1 Interfacing Intelligent Modules

When adding a new digital sensor or a module to a hardware project, we want to test it first, learn how to properly communicate with it and confirm its performance. Based on this evaluation we decide whether the module matches our expectations and learn how to properly connect it, which is needed for a successful PCB layout.

In experimental setups, this may be the only thing we need. Data can readily be collected after just connecting the module to a PC, same as commanding motor controllers or other intelligent devices.

A couple well known hardware buses have established themselves as the standard ways to interface digital sensors and modules: SPI, I2C and UART are the most used ones, often accompanied by a few extra GPIO lines such as Reset, Chip Enable, Interrupt. There are exceptions where silicon vendors have developed proprietary communication protocols that are still used, either for historical reasons or because of their specific advantages. An example is the 1-Wire protocol used by digital thermometers.

Moving to industrial and automotive environments, we can encounter various fieldbuses, Ethernet, CAN, current loop, HART, LIN, DALI, RS485 (e.g. Modbus), mbus, PLCBUS and others. Those typically use transceiver ICs and other circuitry, such as TVS, discrete filters, galvanic isolation etc. They could be supported using add-on boards and additional firmware modules handling the protocol. For simplicity and to meet time constraints, the development of those boards and modules will be left for future expansions of the project.

#### 2.0.2 Analog Signal Acquisition

Sometimes it's necessary to use a traditional analog sensor, capture a transient waveform or to just measure a voltage. GEX was meant to focus on digital interfaces, however giving it this capability makes it much more versatile. Nearly all microcontrollers include an analog-digital converter which we can use to measure input voltages and, paired with a timer, to records signals varying in time.

Certain tasks, such as capturing transient effects on a thermocouple when inserted into a flame (an example from developing fire-proof materials) demand level triggering similar

to that of oscilloscopes. The converter continuously measures the input voltage and a timed capture starts only after a set threshold is exceeded. This can be accompanied by a pre-trigger feature where the timed capture is continuously running and the last sample is always compared with the threshold, recording a portion of the historic records together with the following samples.

### ■ 2.0.3 Analog Signal Output

An analog signal can not only be measured, but it's often necessary to also generate it. This could serve as an excitation signal for an experiment, for instance to measure the characteristic curves of a diode or a transistor. Conveniently, we can at the same time use GEX's analog input to record the output.

Generating an analog signal is possible using a pulse-width modulation (PWM) or by a dedicated digital-analog converter included in many microcontrollers. Higher frequencies or resolution can be achieved with a dedicated external IC.

### ■ 2.0.4 Logic Level Input and Output

We've covered some more advanced features, but skipped the simplest feature: a direct access to GPIO pins. Considering the latencies of USB and the PC's operating system, this can't be reliably used for "bit banging", however we can still accomplish a lot with just changing logic levels - e.g. to control character LCDs, or emulate some interfaces that include a clock line, like SPI. As mentioned in 2.0.1, many digital sensors and modules use plain GPIOs in addition to the communication bus for out-of-band signaling or features like chip selection or reset.

### ■ 2.0.5 Pulse Generation and Measurement

Some sensors have a variable frequency or a pulse-width modulated (PWM) output. To capture those signals and convert them to a more useful digital value, we can use the external input functions of a timer/counter in the microcontroller. Those timers have many possible configurations and can also be used for pulse counting or a pulse train generation.

## ■ 2.1 Connection to the Host Computer

### ■ 2.1.1 Messaging

USB shall be the primary way of connecting the module to a host PC. Thanks to USB's flexibility, it can present itself as any kind of device or even multiple devices at once.

The most straightforward method of interfacing the board is by passing binary messages in a fashion similar to USART (and plain UART can be available as well). We'll need a duplex connection to enable command confirmations, query-type commands and asynchronous event reporting.

This is possible either using a "Virtual COM port" driver (the CDC/ACM USB class), or through a raw access to the corresponding USB endpoints. Using a raw access avoids potential problems with the operating system's driver interfering or not recognizing the device correctly; on the other hand, having GEX appear as a serial port makes it easier to integrate into existing platforms that have a good serial port support (such as National Instruments LabWindows CVI or MATLAB).

A wireless attachment is also planned; after establishing a connection, the two-way link should work in a similar manner to UART or USB.

[link to where this is better explained](#)

### 2.1.2 Configuration Files

The module must be easily reconfigurable. Given the settings are almost always going to be tied on the connected external hardware, it would be practical to have an option to store them permanently in the microcontroller's non-volatile memory.

We can load those settings into GEX using the serial interface, which also makes it possible to reconfigure it remotely when the wireless connection is used. With USB, we can additionally make the board appear as a mass storage device and expose the configuration as text files. This approach, inspired by ARM mbed's mechanism for flashing firmware images to development kits, avoids the need to create a configuration GUI, instead using the PC OS's built-in applications like File Explorer and Notepad. We can expose additional information, such as a README file with instructions or a pin-out reference, as separate files on the virtual disk.

## 2.2 Planned Feature List

Let's list the features we wish to initially support in the GEX firmware:

- **Hardware interfacing functions**
  - I/O pin direct access (read, write), pin change interrupt
  - Analog input: voltage measurement, sampled capture
  - Analog output: static level, waveform generation
  - Frequency, duty cycle, pulse length measurement
  - Single pulse and PWM generation
  - SPI, I<sup>2</sup>C, UART/USART
  - Dallas 1-Wire
  - NeoPixel (addressable LED strips)
- **Communication with the host computer**
  - USB connection as virtual serial port or direct endpoint access

- Connection using plain UART
- Wireless attachment
- **Configuration**
  - Fully reconfigurable, temporarily or permanently
  - Settings stored in INI files
  - File access through the communication API or using a virtual mass storage

## 2.3 Microcontroller Selection

The STM32F072 microcontroller was chosen for the built prototypes and the initial firmware, owing to its low cost, advanced peripherals and the availability of development boards. GEX can be later ported to other MCUs, like the STM32L072, STM32F103 or STM32F303.

The STM32F072 is a Cortex M0 device with 128 KiB of flash memory, 16 KiB of RAM and running at 48 MHz. It is equipped with a USB Full Speed peripheral block, a 12-bit ADC and DAC, a number of general purpose timers/counters, SPI, I<sup>2</sup>C, and USART peripherals, among others. It supports crystal-less USB, using the USB SOF packet for synchronization of the internal 48 MHz RC oscillator; naturally, a real crystal resonator will provide better timing accuracy.

To effectively utilize the time available for this work, only the STM32F072 firmware will be developed while making sure the planned expansion is as straightforward as possible.

## 2.4 Form Factor Considerations

It was mentioned in 1.1 that, while the GEX firmware can be used with existing evaluation boards from ST Microelectronics (figure 2.1), we wish to design and realize a few custom hardware prototypes that will be smaller, more convenient to use and hopefully also cheaper. Three possible form factors are drawn in figure 2.2.

Several factors play a role when deciding what the GEX PCB should look like:

The device must be comfortable and easy to use, which affects the choice of the USB connector, also with respect to cable availability: USB type A is not suitable for desktop computers where it would have to be plugged in the rear of the computer or in the front panel, but it may be usable with laptops; USB Mini-B and Micro-B connectors are both a popular choice in existing kits (e.g. Discovery and Nucleo boards), but Micro-B has a higher rated number of insertions and the cables are ubiquitous thanks to their use in mobile phones, therefore this appears to be the better connector choice.

link to  
the in-  
sertion  
count  
spec

The PCB size should be kept minimal to save manufacturing costs. When a standard connector shape and a pin assignment are used we gain the ability to install existing add-on boards designed for other platforms, like the Arduino or Raspberry Pi. Lastly, when the entire board shape is copied from an existing commercial product for which we can buy official or after-market cases, we get an easy access to cases without having to design them ourselves. This is the case of the Raspberry Pi Zero form factor.



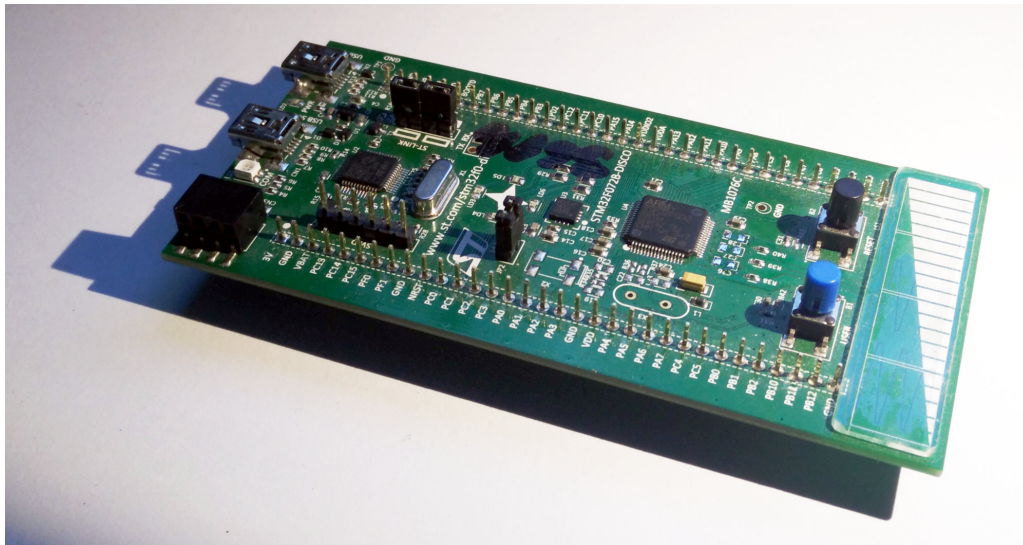

**Figure 2.1:** A Discovery board with STM32F072 that can be used to run the GEX firmware

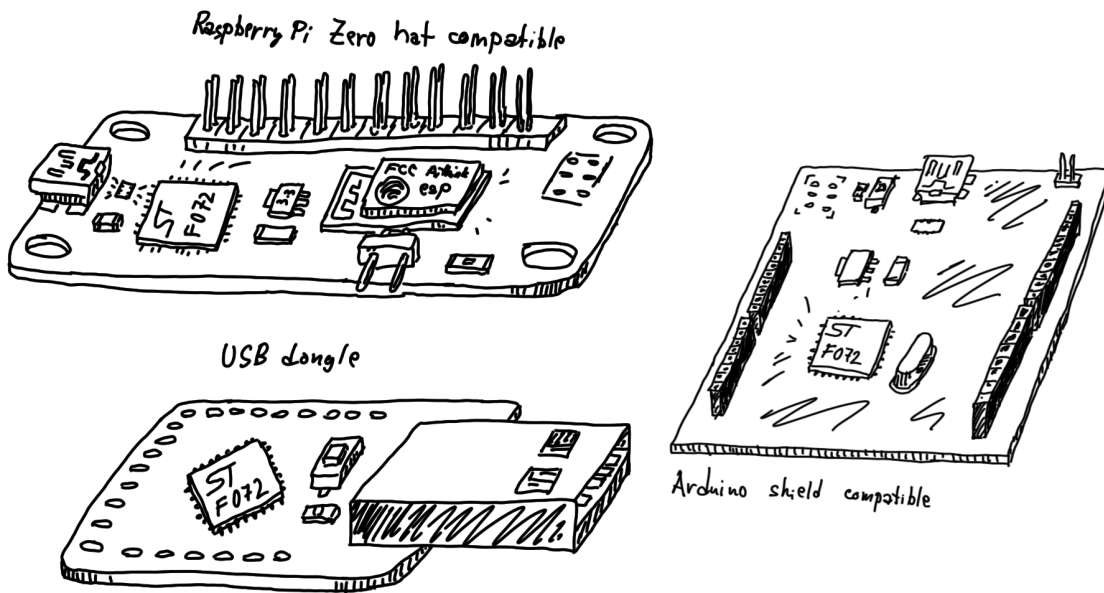

**Figure 2.2:** A sketch of three possible form factors for the GEX hardware prototype. Note the ESP8266 module which was considered as an option for wireless access but was eventually not used due to its high current usage, unsuitable for battery operation.



## Chapter 3

### Existing Solutions

The idea of making it easier to interact with low level hardware from a PC is not new. Several solutions to this problem have been developed, each with its own advantages and drawbacks. Some examples will be presented in this chapter.

#### 3.1 Bus Pirate

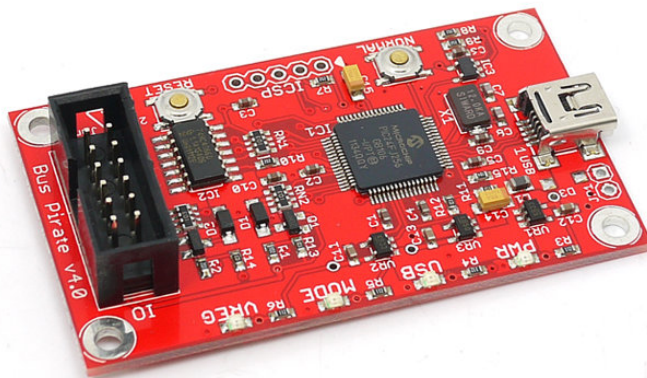

Figure 3.1: Bus Pirate v.4 (picture by *Seed Studio*)

[link to pic source page](#)

Bus Pirate, developed by [Ian Lesnet](#) at [Dangerous Prototypes](#) and manufactured by [Seed Studio](#), is a USB-attached device providing access to hardware interfaces like SPI, I<sup>2</sup>C, USART and 1-Wire, as well as frequency measurement and direct pin access.

The board aims to make it easy for users to familiarize themselves with new chips and modules; it also provides a range of programming interfaces for flashing microcontroller firmwares and memories. It communicates with the PC using a FTDI USB-serial bridge.

Bus Pirate is open source and in scope it's similar to GEX. It can be scripted and controlled from languages like Python or Perl, connects to USB and provides a good selection of hardware interfaces.

The board is based on a PIC16 microcontroller running at 32 MHz. Its analog/digital converter (ADC) only has a resolution of 10 bits (1024 levels). There is no digital/analog

converter (DAC) available on the chip, making applications that require a varied output voltage more difficult. Another limitation of the board is its low number of GPIO pins which may be insufficient for certain applications. The Bus Pirate, at the time of writing, can be purchased for a price similar to some Raspberry Pi models.

## 3.2 Raspberry Pi

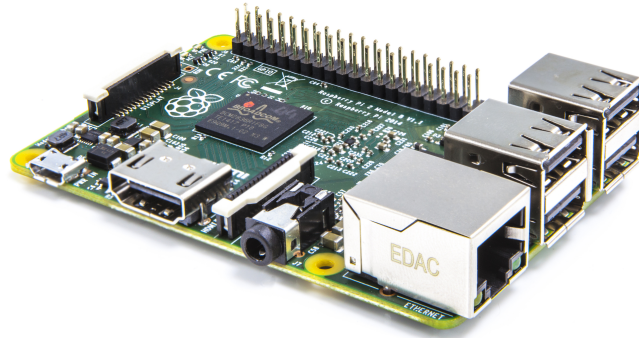

**Figure 3.2:** Raspberry Pi 2 (picture by *Raspberry Pi Foundation*)

The Raspberry Pi's GPIO header, which can be directly controlled by user applications, was one of the primary inspirations behind GEX. It can be controlled using C and Python (among others) and offers general purpose I $\O$ , SPI, I $^2$ C, UART and PWM, with other protocols being easy to emulate thanks to the high speed of the system processor.

The Raspberry Pi is commonly used in schools as a low-cost PC alternative that encourage students' interest in electronics, programming and science. The board is often built into more permanent projects that make use of its powerful processor, such as wildlife camera traps or home automation projects.

The Raspberry Pi could be used for the same quick evaluations or experiments we want to perform with GEX, however they would either have to be performed directly on the mini-computer itself with attached monitor and keyboard, or use some form of remote access (e.g. SSH). When we have a more powerful computer available, a USB device like GEX would be more convenient.

## 3.3 Professional DAQ Modules

Various professional tools that would fulfill our needs exist on the market, but their high price makes them inaccessible for users with a limited budget, such as hobbyists or students who would like to keep such a device for personal use. An example is the National Instruments (NI) "I $^2$ C/SPI Interface Device" which also includes several GPIO lines, the NI USB DAQ module, or some of the Total Phase I $^2$ C/SPI gadgets (figure 3.3). The performance GEX can provide may not always match that of those professional tools, but in many cases it'll be a sufficient substitute at a fraction of the cost.

(a) : NI I<sup>2</sup>C/SPI Interface Device

(b) : NI USB DAQ module

(c) : Total Phase SPI/I<sup>2</sup>C Host "Aardvark"

**Figure 3.3:** An example of professional tools that GEX could replace in less demanding scenarios (pictures taken from marketing materials)

## 3.4 The Firmata Protocol

### links

Firmata is a communication protocol based on MIDI (*Musical Instrument Digital Interface*) for passing data to and from embedded microcontrollers. MIDI is mainly used for attaching electronic musical instruments, such as synthesizers, keyboards, mixers etc., to each other or to a PC. Firmata was designed for Arduino as a high level abstraction for its connection to the PC, typically using a FTDI chip or equivalent.

Implementing Firmata in the GEX firmware would make it possible to use existing Firmata libraries on the PC side. However, the protocol is limited by the encompassing MIDI format and isn't very flexible.





## **Part II**

### **Theoretical Background**





# Chapter 4

## Universal Serial Bus

This chapter presents an overview of the *Universal Serial Bus (USB) Full Speed* interface, with focus on the features used in the GEX firmware. USB is a versatile but complex interface, thus explaining it in its entirety is beyond the scope of this text. References to external material which explains the protocol in greater detail will be provided where appropriate.

add those refs

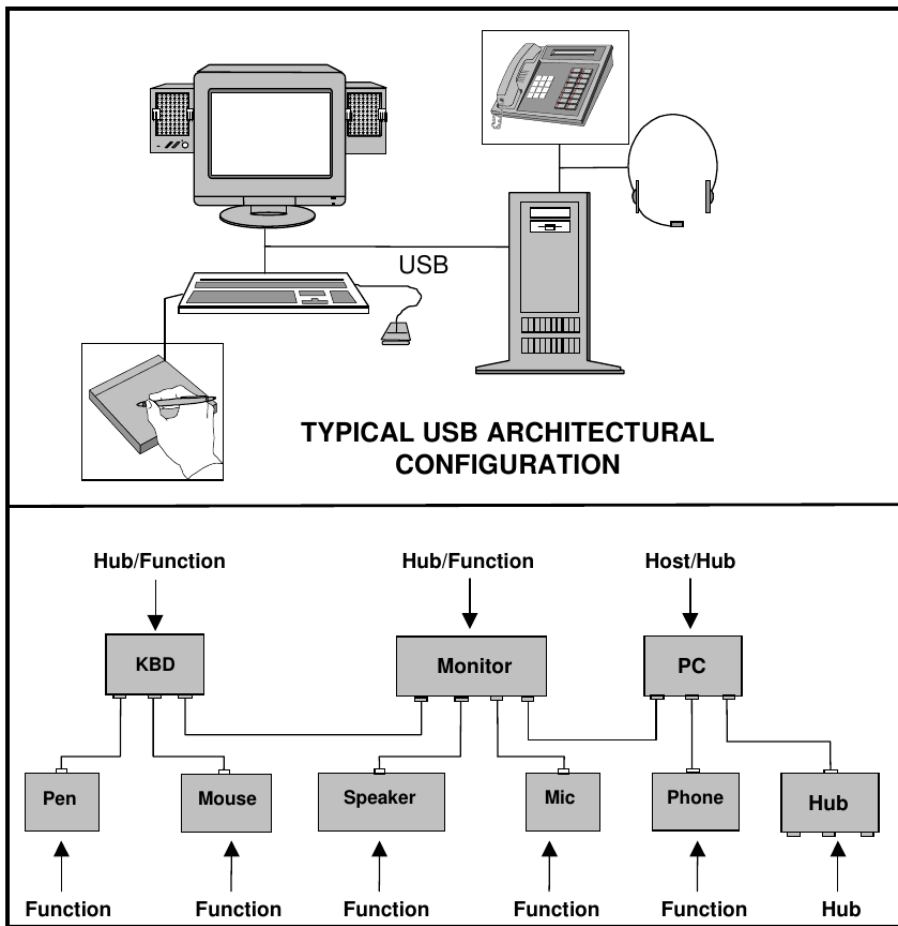

**Figure 4.1:** A diagram from the USB specification rev. 1.1 showing the hierarchical structure of the USB bus; The PC (Host) controls the bus and initiates all transactions.

## 4.1 Basic Principles and Terminology

review and correct inaccuracies

USB is a hierarchical bus with a single master (*host*) and multiple slave devices. A USB device that provides functionality to the host is called a *function*. Communication between the host and a function is organized into virtual channels called *pipes*. Each pipe is identified by an *endpoint* number.

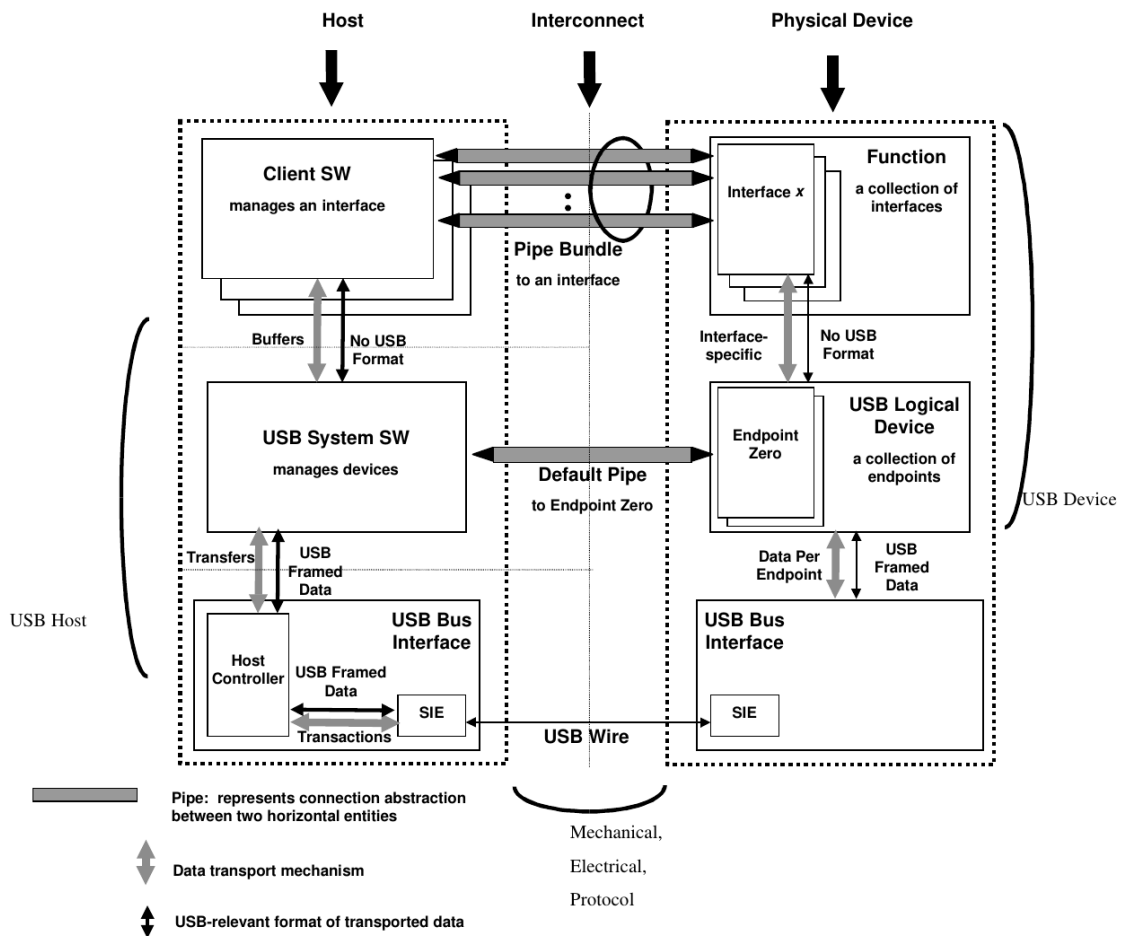

Figure 4.2: A detailed view of the host-device connection (*USB specification rev. 1.1*)

Endpoints can be either unidirectional or bidirectional; the direction from the host to a function is called *OUT*, the other direction (function to the host) is called *IN*. A bidirectional endpoint is technically composed of a *IN* and *OUT* endpoint with the same number. All transactions (both *IN* and *OUT*) are initiated by the host; functions have to wait for their turn. Endpoint 0 is bidirectional, always enabled, and serves as a *control endpoint*. The host uses the control endpoint to read information about the device and configure it as needed.

There are four types of transfers: control, bulk, isochronous, and interrupt. Each endpoint is configured for a fixed transfer type.

- *Control* - initial configuration after device plug-in; also used for other application-specific control messages that can affect other pipes.
- *Bulk* - used for burst transfers of large messages, commonly e.g. for mass storage devices
- *Isochronous* - streaming with guaranteed low latency; designed for audio or video streams where some data loss is preferred over stuttering
- *Interrupt* - low latency short messages, used for human interface devices like mice and keyboards

The endpoint transfer type and other characteristics, together with other information about the device, such as the serial number, are defined in a *descriptor table*. This is a tree-like binary structure defined in the function's memory. The descriptor table is loaded by the host to learn about the used endpoints and to attach the right driver to it.

The function's endpoints are grouped into *interfaces*. An interface describes a logical connection of endpoints, such as the reception and transmission endpoint that belong together. An interface is assigned a *class* defining how it should be used. Standard classes are defined by the USB specification to provide a uniform way of interfacing devices of the same type, such as human-interface devices (mice, keyboards, gamepads) or mass storage devices. The use of standard classes makes it possible to re-use the same driver software for devices from different manufacturers. The class used for the GEX's "virtual COM port" function was originally meant for telephone modems, a common way of connecting to the Internet at the time the first versions of USB were developed. A device using this class will show as `/dev/ttyACM0` on Linux and as a COM port on Windows, provided the system supports it natively or the right driver is installed.

[add reference to the document](#)

#### 4. Universal Serial Bus

```

Device Descriptor:
  bLength           18
  bDescriptorType   1
  bcdUSB            2.00
  bDeviceClass      239 Miscellaneous Device
  bDeviceSubClass   2
  bDeviceProtocol   1 Interface Association
  bMaxPacketSize0   64
  idVendor          0x0483 STMicroelectronics
  idProduct         0x572a
  bcdDevice         0.01
  iManufacturer     1 MightyPork
  iProduct          2 GEX
  iSerial           3 0029002F-42365711-32353530
  bNumConfigurations 1
Configuration Descriptor:
  bLength           9
  bDescriptorType   2
  wTotalLength      98
  bNumInterfaces    3
  bConfigurationValue 1
  iConfiguration    0
  bmAttributes      0x80
    (Bus Powered)
  MaxPower          500mA
Interface Descriptor:
  bLength           9
  bDescriptorType   4
  bInterfaceNumber  0
  bAlternateSetting 0
  bNumEndpoints     2
  bInterfaceClass   8 Mass Storage
  bInterfaceSubClass 6 SCSI
  bInterfaceProtocol 80 Bulk-Only
  iInterface        4 Settings VFS
Endpoint Descriptor:
  bLength           7
  bDescriptorType   5
  bEndpointAddress  0x81 EP 1 IN
  bmAttributes      2
    Transfer Type   Bulk
    Synch Type      None
    Usage Type      Data
  wMaxPacketSize    0x0040 1x 64 bytes
  bInterval         0
Endpoint Descriptor:
  bLength           7
  bDescriptorType   5
  bEndpointAddress  0x01 EP 1 OUT
  bmAttributes      2
    Transfer Type   Bulk
    Synch Type      None
    Usage Type      Data
  wMaxPacketSize    0x0040 1x 64 bytes
  bInterval         0
Interface Association:
  bLength           8
  bDescriptorType   11
  bFirstInterface   1
  bInterfaceCount   2
  bFunctionClass    2 Communications
  bFunctionSubClass 2 Abstract (modem)
  bFunctionProtocol 1 AT-commands (v.25ter)
  iFunction         5 Virtual Comport ACM
Interface Descriptor:
  bLength           9
  bDescriptorType   4
  bInterfaceNumber  1
  bAlternateSetting 0
  bNumEndpoints     1
  bInterfaceClass   2 Communications
  bInterfaceSubClass 2 Abstract (modem)
  bInterfaceProtocol 1 AT-commands (v.25ter)
  iInterface        5 Virtual Comport ACM
CDC Header:
  bcdCDC           1.10
CDC Call Management:
  bmCapabilities   0x00
  bDataInterface   2
CDC ACM:
  bmCapabilities   0x06
    sends break
    line coding and serial state
CDC Union:
  bMasterInterface 1
  bSlaveInterface  2
Endpoint Descriptor:
  bLength           7
  bDescriptorType   5
  bEndpointAddress  0x83 EP 3 IN
  bmAttributes      3
    Transfer Type   Interrupt
    Synch Type      None
    Usage Type      Data
  wMaxPacketSize    0x0008 1x 8 bytes
  bInterval         255
Interface Descriptor:
  bLength           9
  bDescriptorType   4
  bInterfaceNumber  2
  bAlternateSetting 0
  bNumEndpoints     2
  bInterfaceClass   10 CDC Data
  bInterfaceSubClass 0
  bInterfaceProtocol 0
  iInterface        6 Virtual Comport CDC
Endpoint Descriptor:
  bLength           7
  bDescriptorType   5
  bEndpointAddress  0x02 EP 2 OUT
  bmAttributes      2
    Transfer Type   Bulk
    Synch Type      None
    Usage Type      Data
  wMaxPacketSize    0x0040 1x 64 bytes
  bInterval         0
Endpoint Descriptor:
  bLength           7
  bDescriptorType   5
  bEndpointAddress  0x82 EP 2 IN
  bmAttributes      2
    Transfer Type   Bulk
    Synch Type      None
    Usage Type      Data
  wMaxPacketSize    0x0040 1x 64 bytes
  bInterval         0

```

**Figure 4.3:** USB descriptors of a GEX prototype obtained using `lsusb -vd vid:pid`

## 4.2 USB Physical Layer

USB uses differential signaling with NRZI encoding (*Non Return to Zero Inverted*, fig. 4.4) and bit stuffing. The encoding, together with frame formatting, checksum verification, retransmission, and other low level aspects of the USB connection are entirely handled by the USB block in the microcontroller's silicon; normally we do not need to worry about those details. What needs more attention are the electrical characteristics of the bus, which need to be understood correctly for a successful schematic and PCB design.

The USB cable contains 4 conductors:

- $V_{\text{BUS}}$  (+5 V)
- D+
- D-
- Ground

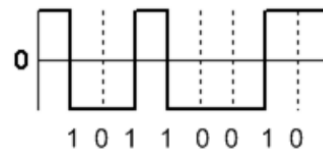

Figure 4.4: NRZI encoding example

The data lines, D+ and D-, are also commonly labeled DP and DM. This differential pair should be routed in parallel and kept at approximately the same length.

USB revisions are, where possible, backwards compatible, often even keeping the same connector shape. The bus speed is negotiated by the device using a  $1.5\text{ k}\Omega$  pull-up resistor to 3.3 V on one of the data lines: for Full Speed, D+ is pulled high (fig. 4.5), for Low Speed it's on D-. The polarity of the differential signals is inverted depending on the used speed. Some microcontrollers integrate the correct pull-up resistor inside the USB block (including out STM32F072), removing the need for an external resistor.

When a function wants to be re-enumerated by the host, which is needed to reload the descriptors and re-attach the correct drivers, it can momentarily remove the pull-up resistor, which the host will interpret as if the device was plugged out. With an internal pull-up this can be done by flipping a bit in a control register. An external resistor can be connected through a transistor controlled by a GPIO pin.

<https://www.eevblog.com/forum/projects/driving-the-1k5-usb-pull-up-resistor-on-d/>

<http://www.beyondlogic.org/usbnutshell/usb2.shtml>

The  $V_{\text{BUS}}$  line supplies power to *bus-powered* devices. *Self-powered* devices can leave this pin unconnected and instead use an external power supply. The maximal current drawn from the  $V_{\text{BUS}}$  line is configured using a descriptor and should not be exceeded, but experiments suggest this is often not enforced.

## 4.3 USB Classes

This section explains the Mass Storage class and the CDC/ACM class that are used in the GEX firmware. A list of all standard classes with a more detailed explanation can be found on the USB.org website at [http://www.usb.org/developers/defined\\_class](http://www.usb.org/developers/defined_class).

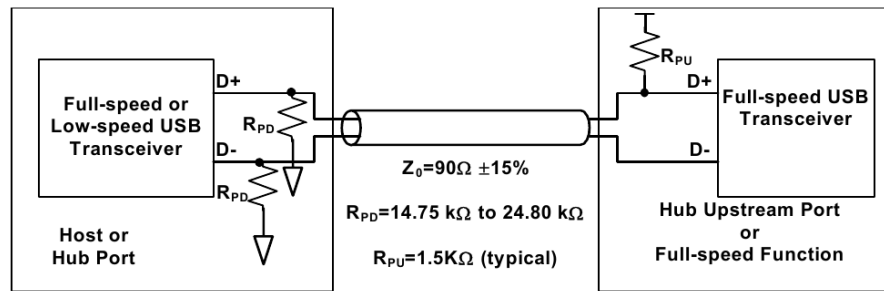

**Figure 4.5:** Pull-up and pull-down resistors of a Full Speed function, as prescribed by the USB specification rev. 2.0

### 4.3.1 Mass Storage Class

The Mass Storage class (MSC) is supported by all modern operating systems (MS Windows, MacOS, GNU/Linux, FreeBSD etc.) to support thumb drives, external disks, memory card readers and other storage devices.

#### references

The MSC specification defines multiple *transport protocols* that can be selected using the descriptors. For its simplicity, the *Bulk Only Transport* (BOT) will be used. BOT uses two bulk endpoints for reading and writing blocks of data and for the exchange of control commands and status messages. For the device to be recognized by the operating system, it must also implement a *command set*. Most mass storage devices use the *SCSI Transparent command set*<sup>1</sup>. The command set's commands let the host read information about the attached storage, such as its capacity, and check for media presence and readiness to write or detach. This is used e.g. for the "Safely Remove" function which checks that all internal buffers have been written to Flash.

#### links

The MSC class together with the SCSI command set are implemented in a USB Device library provided by ST Microelectronics. The library also includes a basic CDC/ACM implementation (see below).

In order to emulate a mass storage device without having a physical storage medium, we need to generate and parse the filesystem on-the-fly as the host OS tries to access it. This will be discussed in chapter 6.

### 4.3.2 CDC/ACM Class

Historically meant for modem communication, this class is now the de facto standard way of making USB devices appear as serial ports on the host OS. The CDC (*Communication Device Class*) uses three endpoints: bulk IN and OUT, and an interrupt endpoint.

<sup>1</sup>To confirm this assertion, the descriptors of five thumb drives and an external hard disk were analyzed using `lsusb`. All but one device used the SCSI command set, one (the oldest thumb drive) used *SFF-8070i*. A list of possible command sets can be found in TODO (usb spec overview)

The interrupt endpoint is used for control commands and notifications while the bulk endpoints are used for useful data. ACM stands for *Abstract Control Model* and it's a CDC's subclass that defines the control messages format. Since we don't use a physical UART and the line is virtual both on the PC and in the end device, the control commands can be ignored.

verify  
this vvv

An interesting property of this class is that the bulk endpoints transport raw data without any wrapping frames. By changing the device class in the descriptor table to 255 (*Vendor Specific Class*), we can retain the messaging functionality of the designated endpoints and access the device directly using e.g. libUSB, while the OS will ignore it and won't try to attach any driver that could interfere otherwise. The same trick can be used to hide the mass storage class when not needed.

### 4.3.3 Interface Association: Composite Class

Since it's creation, the USB specification expected that each function will have only one interface enabled at a time. After it became apparent that there is a need for having multiple unrelated interfaces work in parallel, a workaround called the *Interface Association Descriptor* (IAD) was introduced. IAD is an entry in the descriptor table that defines which interfaces belong together and should be handled by the same software driver.

To use the IAD, the function's class must be set to 239 (EFh), subclass 2 and protocol 1, so the OS knows to look for the presence of IADs before binding drivers to any interfaces.

In GEX, the IAD is used to tie together the CDC and ACM interfaces while leaving out the MSC interface which should be handled by a different driver. To make this work, a new *composite class* had to be created as a wrapper for the library-provided MSC and CDC/ACM implementations.





# Chapter 5

## FreeRTOS

FreeRTOS is a free, open-source real time operating system kernel that has been ported to over 30 microcontroller architectures. The kernel provides a scheduler and implements queues, semaphores and mutexes that are used for message passing between concurrent tasks and for synchronization. FreeRTOS is compact designed to be easy to understand; it's written in C with the exception of some architecture-specific routines that use assembly.

FreeRTOS is used in GEX for its synchronization objects and queues that make it easy to safely pass messages from USB interrupts to a working thread that processes them and sends back responses. Similar mechanism is used to handle external interrupts.

### 5.1 Basic FreeRTOS Concepts and Functions

#### 5.1.1 Tasks

Threads in FreeRTOS are called *tasks*. Each task is assigned a memory area to use as its stack space, and a structure with its name, saved context and other metadata used by the kernel. A context includes the program counter, stack pointer and other register values. Task switching is done by saving and restoring this context by manipulating the values on stack before leaving and interrupt.

At start-up the firmware initializes the kernel, registers tasks to run and starts the scheduler. From this point onward the scheduler is in control and runs the tasks using a round robin scheme. Which task should run is primarily determined by their priority numbers, but there are other factors. FreeRTOS supports both static and dynamic object creation, including registering new tasks at run-time.

#### Task Run States

Tasks can be in one of four states: Suspended, Ready, Blocked, Running. The Suspended state does not normally occur in a task's life cycle, it's entered and left using API calls on demand. A task is in the Ready state when it can run, but is currently paused because a higher priority task is running. It enters the Running state when the scheduler switches to it. A Running task can wait for a synchronization object (e.g. a mutex) to be available. At this point it enters a Blocked state and the scheduler runs the next Ready task. When no tasks can run, the Idle Task takes control; it can either enter a sleep state to save power, or wait in an infinite loop until another task is available.

## ■ Task Switching and Interrupts

Task switching occurs periodically in a SysTick interrupt, usually every 1 ms. After one tick of run time, the running task is paused (enters Ready state), or continues to run if no higher priority task is available. If a high priority task waits for an object and this is made available in an interrupt, the previously running task is paused and the waiting task is resumed immediately (enters the Running state).

Only a subset of the FreeRTOS API can be accessed from interrupt routines, for example it's not possible to use the delay function or wait for an object with a timeout, because the SysTick interrupt which increments the tick counter has the lowest priority and couldn't run. This is by design to prevent unexpected context switching in nested interrupts.

FreeRTOS uses a *priority inheritance* mechanism to prevent situations where a high priority task waits for an object held by a lower priority task (called *priority inversion*). The blocking task's priority is temporarily raised to the level of the blocked high priority task so it can finish faster and release the held object. Its priority is then degraded back to the original value. When the lower priority task itself is blocked, the same process can be repeated.

### ■ 5.1.2 Synchronization Objects

FreeRTOS provides binary and counting semaphores, mutexes and queues.

Binary semaphores can be used for task notifications, e.g. a task waits for a semaphore to be set by an interrupt when a byte is received on the serial port. This makes the task Ready and if it has a higher priority than the previously running task, it's immediately resumed to process the event.

Counting semaphores are used to represent available resources. A pool of resources (e.g. DMA channels) is accompanied by a counting semaphore, so that tasks can wait for a resource to become available in the pool and then subtract the semaphore value. After finishing with a resource, the semaphore is incremented again and another task can use it.

Mutexes, unlike semaphores, must be taken and released in the same thread (task). They're used to guard exclusive access to a resource, such as transmitting on the serial port. When a mutex is taken, a task that wishes to use it enters Blocked state and is resumed once the mutex becomes available and it can take it.

Queues are used for passing messages between tasks, or from interrupts to tasks. Both sending and receiving queue messages can block until the operation becomes possible.

In GEX, mutexes and semaphores are used for sending messages to the PC, and a queue is used for processing received bytes and to send messages from interrupts, because it's not possible to block on a mutex or semaphore while inside an interrupt routine.

## Chapter 6

# The FAT16 File System and Its Emulation

A file system (FS) is used by GEX to provide a comfortable access to the configuration files. By emulating a Mass Storage USB device, the module appears as a thumb drive on the host PC, and the user can edit its configuration using their preferred text editor. The FAT16 file system was selected for its simplicity and a good cross-platform support.

Three variants of the FAT (File Allocation Table) file system exist: FAT12, FAT16, and FAT32. FAT12 was used on floppy disks and it is similar to FAT16, except for additional size constraints and a FAT entry packing scheme. FAT16 and FAT32 are FAT12's later developments from the time when hard disks became more common and the old addressing scheme couldn't support their larger capacity.

This chapter will explain the structure of FAT16 and the challenges faced when trying to emulate it without a physical data storage.

### 6.1 The General Structure of the FAT File System

The storage medium is organized into *sectors* (or *blocks*), usually 512 bytes long. Those are the smallest addressing unit in the disk structure. The disk starts with a *boot sector*, also called *master boot record* (MBR). That is followed by optional reserved sectors, one or two copies of the file allocation table, and the root directory. All disk areas are aligned to a sector boundary:

Disk area	Size / Notes
Boot sector	1 sector
Reserved sectors	optional
FAT 1	1 or more sectors, depends on disk size
FAT 2	optional, a back-up copy of FAT 1
Root directory	1 or more sectors
Data area	Organized in <i>clusters</i>

**Table 6.1:** Areas of a FAT-formatted disk

### 6.1.1 Boot Sector

This is a 1-sector structure which holds the OS bootstrap code for bootable disks. The first 3 bytes are a jump instruction to the actual bootstrap code located later in the sector. What matters to us when implementing the file system is that the boot sector also contains data fields describing how the disk is organized, what file system is used, who formatted it, etc. The size of the FAT and the root directory is defined here. The exact structure of the boot sector can be found in [XXX](#) or in the attached GEX source code.

add ref  
link

### 6.1.2 File Allocation Table

The data area of the disk is organized in clusters, logical allocation units composed of groups of sectors. The use of a larger allocation unit allows the system to use shorter addresses and thus support a larger disk capacity.

The FAT acts as a look-up table combined with linked lists. In FAT16, it is organized in 16-bit fields, each corresponding to one cluster. The first two entries in the allocation table are reserved and hold special values set by the disk formatter and the host OS: a "media descriptor" 0xFFFF8 and a "clean/dirty flag" 0xFFFF/0x3FFF.

Files can span multiple clusters; each FAT entry either holds the address of the following file cluster, or a value with a special meaning:

- 0x0000 - free cluster
- 0xFFFF - last cluster of the file (still including file data!)
- 0xFFF7 - bad cluster

The bad cluster mark, 0xFFF7, is used for clusters which are known to corrupt data due to a flaw in the storage medium, such as a bad memory cell.

### 6.1.3 Root Directory

The root directory has the same structure as any other directories, which reside in clusters the same way like ordinary files. The difference is that the root directory is allocated when the disk is formatted and it has a fixed and known position and size. Sub-directories are stored on the disk in a similar way to regular files, therefore they can span multiple sectors and their file count can be much larger than that of the root directory.

A directory is organized in 32-byte entries representing individual files. Table 6.2 shows the structure of one such entry.

The name and extension fields form together the well-known 8.3 filename format. Longer file names are encoded using a *long file name* (LFN) scheme as special hidden entries stored in the directory table alongside the regular 8.3 entries, ensuring backward compatibility.

The first byte of the file name has a special meaning:

Offset	Size (bytes)	Description
0	8	File name (padded with spaces)
8	3	File extension
11	1	File attributes
12	10	Reserved
22	2	Creation time
24	2	Creation date
26	2	Address of the first cluster
28	4	File size (bytes)

**Table 6.2:** Structure of a FAT16 directory entry

- 0x00 - indicates that there are no more files when searching the directory
- 0xE5 - marks a free slot; this is used when a file is deleted
- 0x05 - indicates that the first byte should actually be 0xE5, which was used in a Japanese character set.
- Any other value, except 0x20 (space) and characters forbidden in a DOS file name, starts a valid file entry. Generally, only space, A-Z, 0-9, - and \_ should be used in file names for maximum compatibility.

The attributes field contains flags such as *directory*, *volume label*, *read-only* and *hidden*. Volume label is a special entry in the root directory, which defines the disk's label shown on the host PC. A file with the directory bit set is actually a pointer to a subdirectory, meaning that when we open the linked cluster, we'll find a new directory table.

Figure 6.1 shows a possible organization of the GEX file system with two INI files, one spanning two clusters, the other being entirely inside one. The clusters need not be used completely; an exact file size is stored in the directory entries.

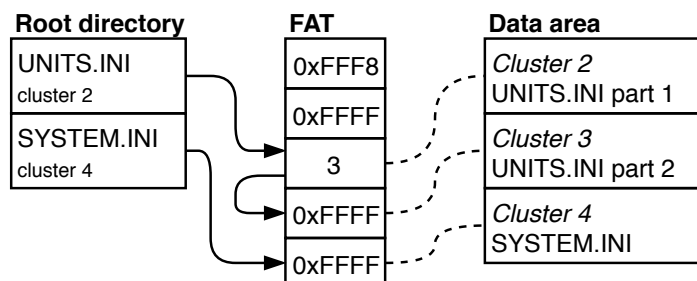

**Figure 6.1:** An example of the GEX virtual file system

## 6.2 FAT16 Emulation

reference

The FAT16 file system is relatively straightforward and easy to implement. This is the reason why an emulation driver for it was developed as part of the open-source ARM mbed DAPLink project. It is used there for a drag-and-drop flashing of firmware images to the target microcontroller, taking advantage of it working well across different host platforms. ARM mbed uses a browser-based IDE and cloud build servers, thus the end user does not need to install or set up any software or drivers to program a compatible development kit. The GEX firmware adapts several parts of this code, optimizes its RAM usage and further expands its functionality to support our specific use case.

It is not practical or even possible to keep the entire file system in memory, especially with a microcontroller like the STM32F072, which has only 16 kB of RAM in total. This means that we have to generate and parse disk sectors and clusters on-demand, when the host reads or writes them. The STM32 USB Device library helpfully implements the Mass Storage USB class and provides API endpoints to which we connect our file system emulator. Specifically, those are requests to read and write a sector, and to read disk status and parameters, such as its size.

As shown in table 6.1, the disk consists of several areas. The boot sector is immutable and can be stored in Flash. The handling of the other areas (FAT, data area) depends on whether we're dealing with a read or write access:

### 6.2.1 Handling a Read Access

The user can only read files that already exist on the disk, in our case, `UNITS.INI` and `SYSTEM.INI`. Those files are generated from the binary settings storage, and conversely, parsed, line-by-line, without ever existing in their full form. This fact makes our task more challenging, as the files can't be easily measured and there's no obvious way to read a sector from the middle of a longer file. We solve this by implementing two additional functions in the INI file writer: a *read window* and a *dummy read mode*.

A read window is a byte range which we wish to generate. The INI writer discards bytes before the start of the read window, writes those inside the window to our data buffer, and stops when its end is reached. This lets us extract a sector from anywhere in a file. The second function, dummy read, is tied to the window function: we set the start index so high that it's never reached (e.g. `0xFFFFFFFF`), and have the writer count discarded characters. When the dummy file generation ends, this character counter holds its size.

Now, just one problem remains: how to tell which sectors contain which part of our files? This is straightforward when we realize that the files change only when the user modifies the settings. After each such change, an algorithm is run which allocates clusters to the files and preserves this information in a holding structure. A subsequent read access simply requires a look into this structure and the corresponding chunk of a file may be served using the read window function. The FAT can be dynamically generated from this information as well.

## 6.2.2 Handling a Write Access

A file write access is more challenging to emulate than a read access, as the host OS tends to be somewhat unpredictable. In GEX's case we're interested only in the action of overwriting an already existing file, but it's interesting to also analyze other actions the host may perform.

It must be noted that due to the nonexistence of a physical storage medium, it's not possible to read back a file the host has written. The OS may show the written file on the disk, but when the user tried to read it, it either fails, or shows a cached copy. In the DAPLink emulator this is worked around by temporarily reporting that the storage medium has been removed, forcing the host to re-load its contents. In GEX, the loaded INI file will be a newly generated copy, embedding possible error messages as comments.

## 6.2.3 File Deletion

A file is deleted by:

1. Marking all sectors used by it as free in the FAT
2. Replacing the first character of its name in the directory table by 0xE5 to indicate the slot is free

From the perspective of emulation, we can ignore the FAT access and only detect writes to the directory sectors. This is slightly more complicated when one considers that all disk access is performed in sectors: the emulator must compare the written data with the original bytes to detect what change has been performed. Alternatively, we could parse the written sector as a directory table and compare it with our knowledge of its original contents.

## 6.2.3 File Name Change

A file is renamed by modifying its directory entry. This can be detected in a similar way to a file deletion. In the simple case of a short, 8.3 file name, this is an in-place modification of the file entry. Long file names, using the LFN extension, are a complication, as the number of dummy entries might change when the file name is shortened or made longer, and subsequently the following entries in the table may shift or be entirely re-arranged.

## 6.2.4 File Creation

A new file is created in three steps:

1. Finding free clusters and chaining them by writing the following cluster addresses (or 0xFFFF for the last cluster) into the FAT
2. Finding and overwriting a free entry in the directory table





# Chapter 7

## Supported Hardware Buses

Hardware buses implemented in GEX are presented in this chapter. The description of each bus is accompanied by several examples of devices that can be interfaced with it. The reader is advised to consult the official specifications and particular devices' datasheets for additional technical details.

### 7.1 UART and USART

The *Universal Synchronous / Asynchronous Receiver Transmitter* has a long history and is still in widespread use today. It is the protocol used in RS-232, which was once a common way of connecting modems, printers, mice and other devices to personal computers. UART framing is also used in the industrial bus RS-485.

UART and USART are two variants of the same interface. USART includes a separate clock signal, while the UART timing relies on a well-known clock speed and the bit clock is synchronized by start bits. USART was historically used in modems to achieve higher bandwidth, but is now mostly obsolete.

USART, as implemented by microcontrollers such as the STM32 family, is a two-wire full duplex interface that uses 3.3 V or 5 V logic levels. The data lines are in the high logical level when idle. A frame, pictured in figure 7.1 starts by a start-bit (low level for the period of one bit) followed by  $n$  data bits (typically eight), an optional parity bit and a period of high level called a stop bit or stop bits, usually between one and two bits long.

RS-232 uses the UART framing, but its logic levels are different: logical 1 is represented by negative voltages  $-3$  to  $-25$  V and logical 0 uses the same range, but positive. To convert between RS232 levels and TTL (5 V) levels, a level-shifting circuit such as the MAX232 can be used. In RS232, the two data lines (Rx and Tx) are accompanied by RTS (Ready To Send), CTS (Clear To Send) and DTR (Data Terminal Ready) which facilitate handshaking and hardware flow control. In practice, those additional signals are often unused or their function differs; for instance, Arduino boards (using a USB-serial converter) use the DTR line as a reset signal to automatically enter their bootloader for firmware flashing.

#### 7.1.1 Examples of Devices Using UART

- **MH-Z19B** - NDIR CO<sub>2</sub> concentration sensor

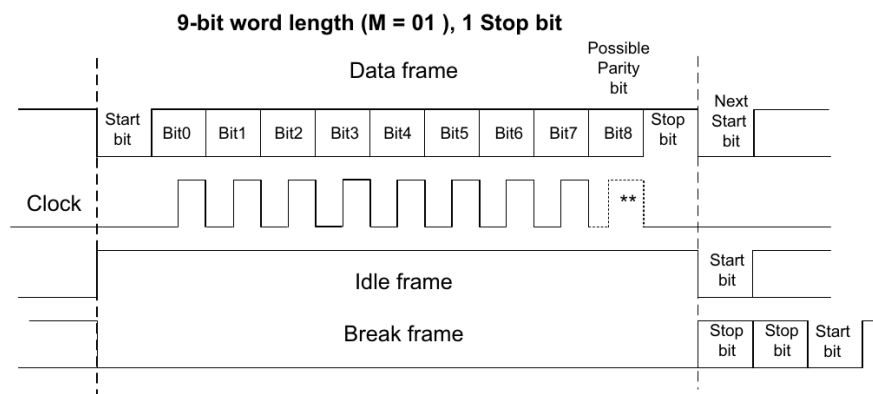

**Figure 7.1:** UART frame, as shown by the STM32F072 Reference Manual. Break frames are used by some UART based protocols, like LIN (Local Interconnect Network).

- **NEO-M8** - uBlox GPS module
- **ESP8266** with AT firmware - a WiFi module
- **MFRC522** - NFC MIFARE reader/writer IC (also supports other interfaces)

## 7.2 SPI

SPI (Serial Peripheral Interface) is a point-to-point or multi-drop master-slave interface based on shift registers. The SPI connection with multiple slave devices is depicted in figure 7.2. It uses at least 4 wires: SCK (Serial Clock), MOSI (Master Out Slave In), MISO (Master In Slave Out) and SS (Slave Select). SS is often marked CSB (Chip Select Bar) or NSS (Negated Slave Select) to indicate it's active low. Slave devices are addressed using their Slave Select input while the data connections are shared. A slave that's not addressed releases the MISO line to a high impedance state so it doesn't interfere in ongoing communication.

Transmission and reception on the SPI bus happen simultaneously. A bus master asserts the SS pin of a slave it wishes to address and then sends data on the MOSI line while receiving a response on MISO. It's customary that the slave responds with zeros or a status byte as the first byte of the response.

SPI devices often provide a number of control, configuration and status registers that can be read and written by the bus master. The first byte of a command usually contains one bit that determines if it's a read or write access, and an address field selecting the target register.

### 7.2.1 Examples of Devices Using SPI

- **SX1276** - LoRa transceiver
- **nRF24L01+** - 2.4 GHz ISM band radio module

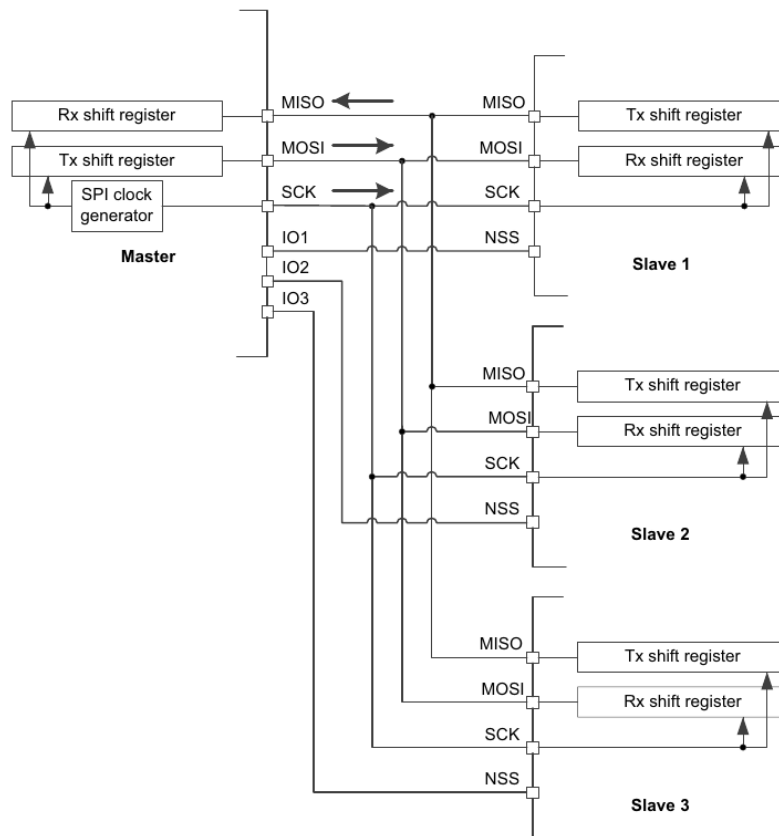

**Figure 7.2:** A SPI bus with 1 master and 3 slaves, each enabled by its own Slave Select signal (*STM32F072 Reference Manual*)

- **L3GD20** - 3-axis gyroscope
- **BMP280** - pressure sensor
- **BME680** - air quality sensor
- **ENC28J60** - Ethernet controller
- **L6470** - intelligent stepper motor driver
- **AD9833** - DDS-based DAC / waveform generator (MOSI only)
- **ADE7912** - triple  $\Sigma$ - $\Delta$  ADC for power metering applications
- **SD cards**
- SPI-interfaced EEPROMs and Flash memories

## 7.3 I2C

I2C is a two-wire (SDA–Serial Data, SCL–Serial Clock), open-drain bus that supports multi-master operation. The protocol was developed by Philips Semiconductor (now NXP



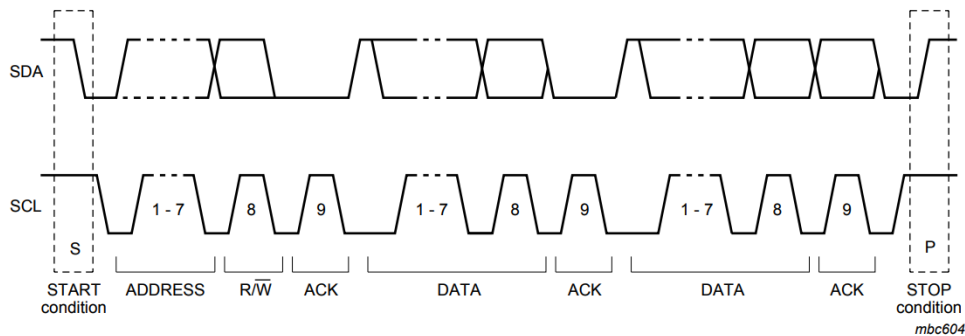

**Figure 7.3:** An I2C message diagram. The frame starts with a start condition and stops with a stop condition, defined by an SDA edge while SCL is high. The address and data bytes are acknowledged by the slave by sending a 0 on the open-drain SDA line in the following clock cycle. A slave can terminate the transaction by sending 1 in place of the acknowledge bit. (Diagram taken from the I2C specification UM10204 by NXP Semiconductors)

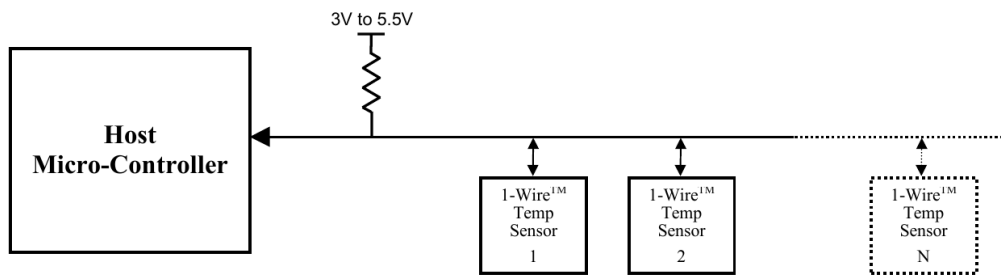

**Figure 7.4:** 1-Wire topology (by Dallas Semiconductor)

#### 7.4.1 Examples of Devices Using 1-Wire

- **DS1820, DS18S20, DS18B20** - digital thermometers
- **iButton** - contact-read access tokens, temperature loggers etc.

Since 1-Wire is a proprietary protocol, there is a much smaller choice of available devices and they also tend to be more expensive. The DS18x20 thermometers are, however, popular enough to warrant the bus's inclusion in GEX.

## 7.5 NeoPixel

NeoPixel is a marketing name of the **WS2811**, **WS2812** and compatible intelligent LED drivers that is commonly used in "addressable LED strips". Those chips include the control logic, PWM drivers and usually the LED diodes all in one miniature package.

The NeoPixel protocol is unidirectional, using only one data pin. The LED drivers are chained together. Ones and zeros are encoded by a pulse length on the data pin; after loading the color data to the LED string, a longer "reset" pulse is issued by the bus master

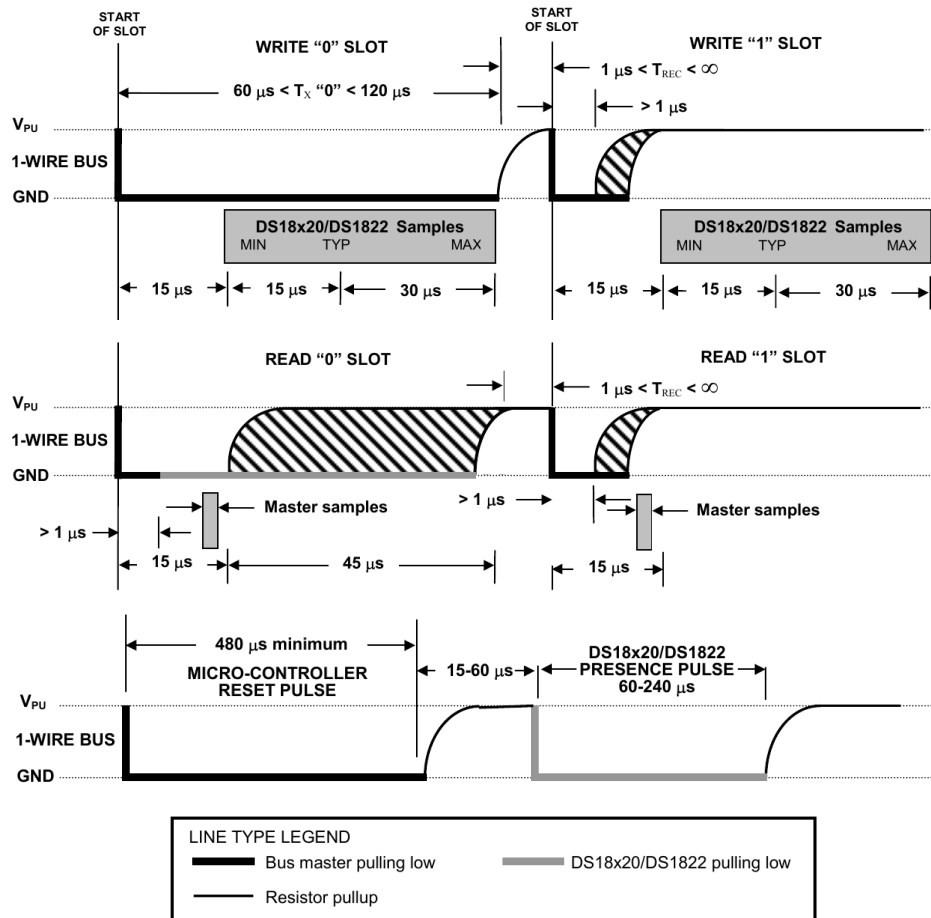

**Figure 7.5:** The 1-Wire DIO pulse timing (by Dallas Semiconductor)

and the set colors are displayed. The timing diagram and constraints are shown in figure 7.7.

The NeoPixel timing is very sensitive to pulse length accuracy. Reliable ways to implement it use DMA with a hardware timer, or a I2S peripheral. An easier method that does not use any additional hardware resources is implementing the protocol as delay loops in the firmware; care must be taken to disable interrupts in the sensitive parts of the timing.

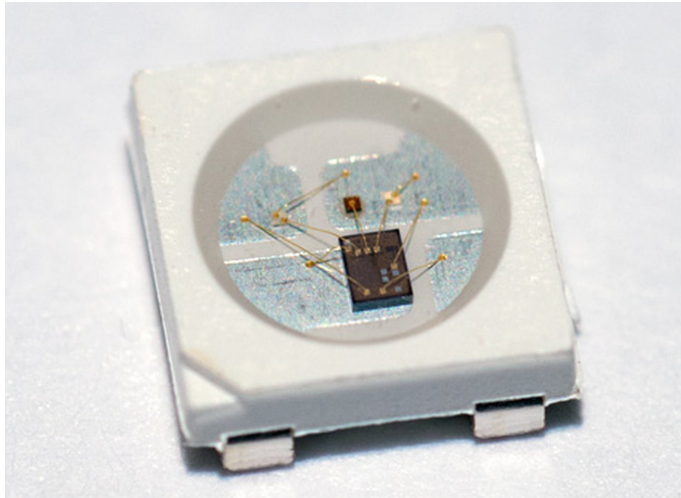

**Figure 7.6:** A close-up photo of the WS2812B package, showing the LED driver IC

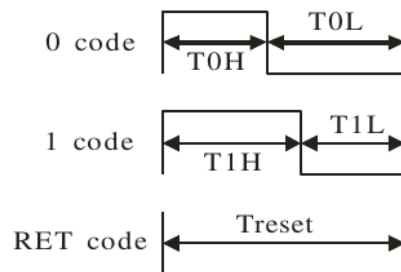

**Data transfer time**(  $T_H+T_L=1.25\mu s\pm 600ns$ )

T0H	0 code ,high voltage time	0.4us	$\pm 150ns$
T1H	1 code ,high voltage time	0.8us	$\pm 150ns$
T0L	0 code , low voltage time	0.85us	$\pm 150ns$
T1L	1 code ,low voltage time	0.45us	$\pm 150ns$
RES	low voltage time	Above 50 $\mu s$	

**Figure 7.7:** NeoPixel pulse timing diagram and time constraints table (*WS2812 datasheet*)





## Chapter 8

### Additional Hardware Functions

In addition to communication buses, described in chapter 7, GEX implements several measurement and output functions that take advantage of the microcontroller's peripheral blocks, such as timers/counters and DAC. The more complicated ones are described here; simpler functions, such as the raw GPIO access, will be described later together with their control API.

#### 8.1 Frequency Measurement

Applications like motor speed measurement and the reading of a VCO (voltage-controlled-oscillator) or VCO-based sensor's output demand a tool capable of measuring frequency. This can be done using a laboratory instrument such as the Agilent 53131A. A low cost solution is to use a timer/counter peripheral of a microcontroller, such as the STM32F072 used in GEX.

Two basic methods to measure frequency exist, each with its advantages and drawbacks:

- The *direct method* (fig. 8.1) is based on the definition of frequency as a number of cycles  $n$  in a fixed-length time window  $\tau$  (usually 1 s); the frequency is then calculated as  $f = n/\tau$ .

One timer generates the time window and its output gates the input of another, configured as a pulse counter. At the end of the measurement window an interrupt is generated and we can read the pulse count from the counter's register.

The direct method has a resolution of 1 Hz with a sampling window of 1 s (only a whole number of pulses can be counted). The resolution can be increased by using a longer time window, provided the measured signal is stable enough to make averaging possible without distorting the result.

- The *indirect or reciprocal method* (fig. 8.2) measures one period  $T$  as the time interval between two pulses and this is then converted to frequency as  $f = 1/T$ .

This method needs only one timer/counter. Cycles of the system clock are counted for the duration of one period on the input pin (between two rising edges). If we additionally detect the falling edge in between, the counter's value gives us the duty cycle when related to the overall period length.

The reciprocal method's resolution depends on the counter's clock speed; if driven at 48 MHz, the tick period is 20.83 ns, which defines the granularity of our time

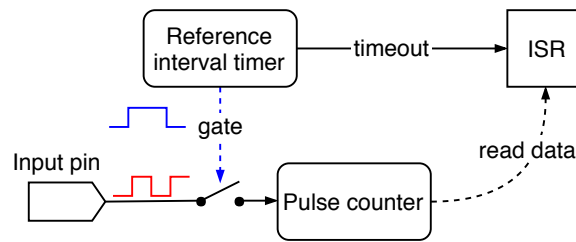

**Figure 8.1:** Direct frequency measurement method

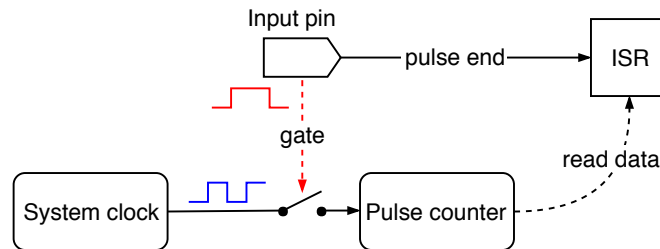

**Figure 8.2:** Reciprocal frequency measurement method

measurement. It is common to measure several pulses and average the obtained values to further increase the precision.

We can easily achieve a sub-hertz resolution with this method, but its performance degrades at high frequencies where the time measurement precision becomes insufficient. The input frequency range can be extended using a hardware prescaler<sup>1</sup>, which is also applicable to the direct method, should the measurement of frequencies outside the counter's supported range be required. A duty cycle measurement available in this method can be used to read the output of sensors that use a pulse-width modulation.

Which method to use depends on the frequency we want to measure; the worst-case measurement errors of both methods, assuming an ideal 48 MHz system clock, are plotted in figure 8.3. It can be seen that the reciprocal method leads in performance up to 7 kHz where the direct method overtakes it. If a higher error is acceptable, the reciprocal method could be used also for higher frequencies to avoid a reconfiguration and to take advantage of its higher speed.

A good approach to a universal measurement, when we don't know the expected frequency beforehand, could be to first obtain an estimate using the direct method, and if the frequency is below the worst-case error crossing point (here 7 kHz), to take a more precise measurement using the reciprocal method.

The system clock's frequency, which we use to measure pulse lengths and to gate the pulse counter, will be affected by tolerances of the used components, the layout of the PCB, temperature effects etc., causing measurement errors. A higher accuracy could be achieved using a temperature-compensated oscillator (TCO), or, in the direct method, by using the synchronization pulse provided by a GPS receiver to time the measurement interval.

<sup>1</sup>*Prescaler* is a divider implemented as part of the timer/counter peripheral block that can be optionally enabled and configured to a desired division factor.

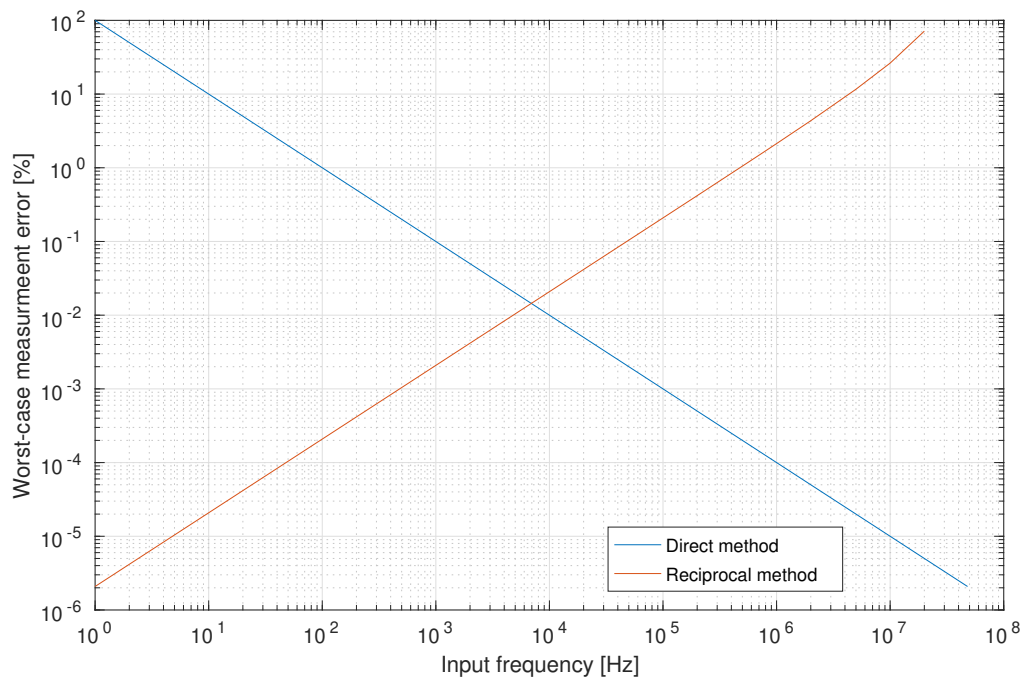

**Figure 8.3:** Worst-case error using the two frequency measurement methods with an ideal 48 MHz timer clock. The crossing lies at 7 kHz with an error of 0.015 %, or 1.05 Hz.

## 8.2 Analog Signal Acquisition

Explain ADC operation and basic concepts / types

## 8.3 Waveform Generation

A waveform generator is a useful tool in many experiments and measurements. A sine stimulus is the basis of a lock-in amplifier; it can be used to measure impedance; with a frequency sweep, we can obtain the frequency response of an analog filter, etc. We can, of course, generate other waveforms, such as a triangle, ramp, or rectangle wave.

The DAC peripheral can produce a DC level on the output pin based on a control word. When we periodically change its digital input, it produces an analog waveform.

### 8.3.1 Waveform Generation with DMA and a Timer

A straightforward implementation of the waveform generator is illustrated in figure 8.4. This approach has its advantages: it's simple and works entirely in the background, with no interrupt handling required. It could even be implemented entirely in software, using a loop periodically updating the DAC values, of course such approach is less flexible and we would run into problems with asynchronous interrupts.

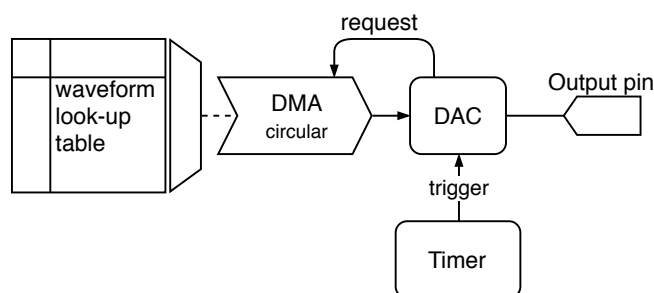

**Figure 8.4:** A simple implementation of the waveform generator

The highest achievable output frequency largely depends on the size of our look-up table. For instance, assuming a timer frequency of 48 MHz and a 8192-word table, holding one period of the waveform, the maximum frequency would be short of 6 kHz, whereas if we shorten the table to just 1024 words, we can get almost 47 kHz on the analog output. The downside of a shorter table is a lower resolution, which will appear as DC plateaus or steps when observed with an oscilloscope, producing harmonic components similar to those of a square wave.

A major disadvantage of this simple generation method is given by the limitations of the used timer, which defines the output frequency. Its output trigger fires when the internal counter reaches a pre-defined value, after which the counting register is reset. The counting speed is derived from the system clock frequency  $f_c$  using a prescaler  $P$  and the set maximum value  $N$ . Only output frequencies that can be exactly expressed as  $f = f_c / (P \cdot N \cdot \text{TableSize})$  can be accurately produced. Still, this simple and efficient method may be used where fine tuning is not required to take advantage of its fully asynchronous operation.

### 8.3.2 Direct Digital Synthesis

There are situations where the simple waveform generation method is not sufficient, particularly when a fine tuning or on-line frequency and phase changes are required. Those are the strengths of a signal generation method called *Direct Digital Synthesis* (DDS).

A diagram of a possible DDS implementation in the STM32 firmware is shown in figure 8.5. It is based on a *numerically controlled oscillator* (NCO). NCO consists of a *phase accumulator* register and a *tuning word* which is periodically added to it at a constant rate in a timer interrupt handler. The value of the tuning word determines the output waveform frequency. The look-up table must have a power-of-two length so that it can be addressed by the  $n$  most significant bits of the phase accumulator. An additional control word could be added to this address to implement a phase offset for applications like a phase-shift modulation.

The output frequency is calculated as  $f_{\text{out}} = \frac{M \cdot f_c}{2^n}$ , where  $M$  is the tuning word,  $n$  is the bit length of the phase accumulator, and  $f_c$  is the frequency of the phase-updating interrupt. The number of bits used to address the look-up table does not affect the output frequency; the table can be as large as the storage space allows. A tuning word value

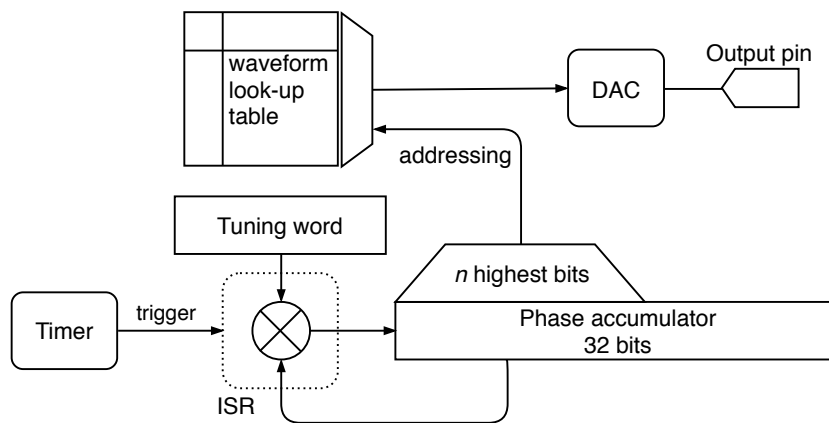

**Figure 8.5:** A block diagram of a direct digital synthesis waveform generator

exceeding the lower part of the phase accumulator (including bits which directly enter the look-up address) will cause some values from the table to be skipped. A smaller tuning word, conversely, makes some values appear on the output more than once. This can be observed as steps or flat areas on the output. When the tuning word does not evenly divide  $2^n$ , that is, the modulo is non-zero, we can also observe jitter.

### ■ DDS Implemented in Hardware

DDS may be implemented in hardware, including the look-up table, often together with the DAC itself, which is then called a *Complete DDS*. That is the case of e.g. AD9833 from Analog Devices. As the software implementation depends on a periodic interrupt, it's often advantageous to use a component like this when we need higher output frequencies where the use of an interrupt is not possible. GEX can control an external waveform generator like the AD9833 using an SPI port.

screenshots of a real demo, also reference to [all-about-direct-digital-synthesis.pdf](#)

## ■ 8.4 Touch Sensing

The used microcontroller, STM32F072, includes a touch sensing controller (TSC) peripheral block. It can be accessed from GEX as a demonstration of capacitive touch sensing, and could possibly be used for simple touch sensors as well, such as measuring the level of water in a tank.

The TSC requires a specific topology with a sampling capacitor connected close to the microcontroller pin, which may not be possible on a universal GEX module; for this reason, the touch sensing feature is best demonstrated on the STM32F072 Discovery development kit, which includes a 4-segment touch slider shown in figure 8.6.

The principle of capacitive touch sensing is well explained in the microcontroller's reference manual . A key part of the TSC is a set of analog switches, which can be combined

ref

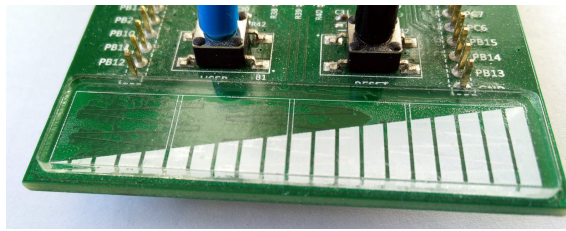
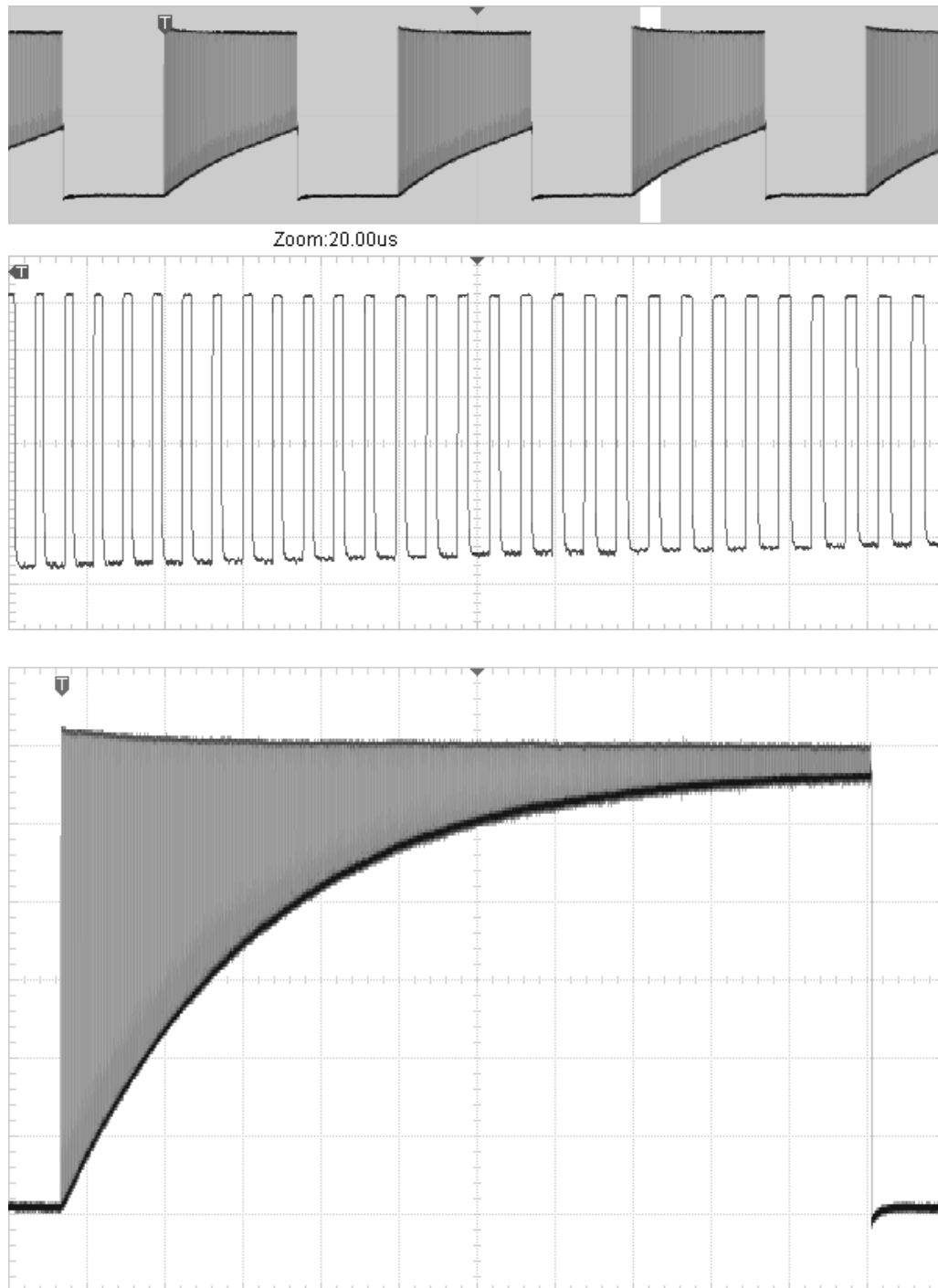

**Figure 8.6:** The touch slider on a STM32F072 Discovery board

to form several different signal paths between the external pins, Vdd, GND, and an analog comparator. Two input pins are needed for every touch sensing channel: the sensing pad connects to one, the other is connected through a sampling capacitor (47 nF on the Discovery board) to GND.

Capacitive sensing is a sequential process described in the following steps:

1. The sensing capacitor is discharged by connecting its free end to GND.
2. The sensing pad is connected to Vdd and, acting as a capacitor, charged to 3.3 V. It stores a small amount of charge, depending on its capacitance—this is the variable property we are trying to measure.
3. The free terminals of the two capacitors (the sensing pad and the sampling capacitor) are connected together and their voltages reach an equilibrium as a portion of the stored charge leaves the sensing pad and flows into the bigger capacitor.
4. The steps (2) and (3) are repeated the sampling capacitor's voltage exceeds a fixed threshold (set to a half of the supply voltage). The number of cycles needed to charge the sampling capacitor corresponds to the capacitance of the sensing pad.



**Figure 8.7:** A voltage waveform measured on the touch sensing pad. The bottom side of the envelope equals the sampling capacitor's voltage—this is the phase where both capacitors are connected. The detailed view (middle) shows the individual charging cycles. The bottom screenshot captures the entire waveform after the analog comparator was disabled.







## **Part III**

### **Implementation**



## Chapter 9

# Application Structure

GEX is designed to be modular and easy to extend. It's composed of a set of functional blocks, sometimes available in more than one instance, which can be configured by the user to fit their application needs. The firmware is built around a *core framework* which provides services to the functional blocks, such as a settings storage, resource allocation, message delivery and periodic updates.

In this chapter, we will focus on the general function of the GEX module and will look at the services provided by the core framework. Individual functional blocks and the control API will be described in the following chapters.

references

*A writing style note:* This and the following parts were written after implementing and evaluating the first hardware prototype and its firmware, therefore rather than describing the development process, it tends to talk about the completed solution and the decisions taken.

### 9.1 User's View of GEX

Before going into implementation details, we'll have a look at GEX from the outside, how an end user will see it. This should give the reader some context to better orient themselves in the following sections and chapters investigating the internal structure of the firmware and the communication protocol.

The GEX firmware can be flashed to a STM32 Nucleo or Discovery board or a custom PCB. It's equipped with a USB connector to connect to the host PC. GEX loads its configuration from the non-volatile memory, configures its peripherals, sets up the function blocks and enables the selected communication interface(s). When USB is connected to the board, the PC enumerates it and either recognizes the communication interface as CDC/ACM (Virtual serial port), or leaves it without a software driver attached, to be accessed directly as raw USB endpoints. This can be configured. The user can now access the functional blocks using the client library and the serial protocol, as well as modify the configuration files.

The board is equipped with a button or a jumper labeled LOCK. When the button is pressed or the jumper removed, the Mass Storage USB interface is enabled. For the user this means a new disk will be detected by their PC's operating system that they can open in a file manager. This disk provides read and write access to configuration INI files and other files with useful information, like a list of supported features and available hardware



When the firmware needs to be ported to a different STM32 microcontroller, the core framework is relatively straightforward to adapt and the whole process can be accomplished in a few hours. The time consuming part is modifying the functional blocks to work correctly with the new device's hardware.

## 9.3 Resource Allocation

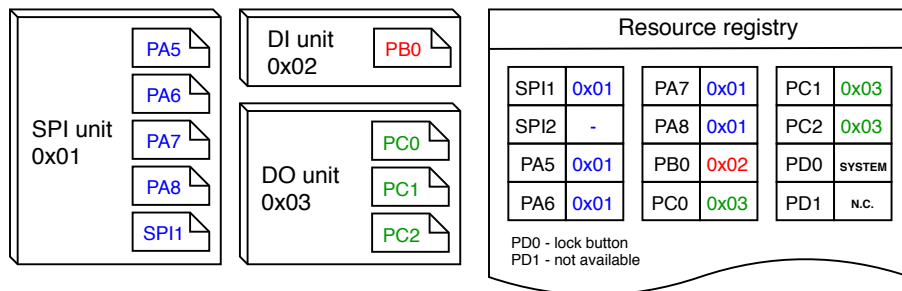

**Figure 9.1:** An example allocation in the resource registry

The microcontroller provides a number of hardware resources that require exclusive access: GPIO pins, peripheral blocks (SPI, I2C, UART...), DMA channels. If two units tried to control the same pin, the results would be unpredictable; similarly, with a multiple access to a serial port, the output would be a mix of the data streams and completely useless.

To prevent a multiple access, the firmware includes a *resource registry* (fig. 9.1). Each individual resource is represented by a field in a resource table together with its owner's callsign. Initially all resources are free, except for those not available on the particular platform (i.e. a GPIO pin PD1 may be disabled if not present on the microcontroller's package).

The resources used by the core framework are taken by a virtual unit **SYSTEM** on start-up to prevent conflicts with the user's units. This is the case of the status LED, the LOCK button, USB pins, the communication UART, the pins and an SPI peripheral connecting the wireless module, pins used for the crystal oscillator, and the timer/counter which provides the system timebase.

## 9.4 Settings Storage

The system and unit settings are written, in a binary form, into designated pages of the microcontroller's Flash memory. The unit settings serialization and parsing is implemented by the respective unit drivers.

As the settings persist after a firmware update, it's important to maintain backwards compatibility. This is achieved by prefixing the unit's settings by a version number. When the settings are loaded by a new version of the firmware, it first checks the version and

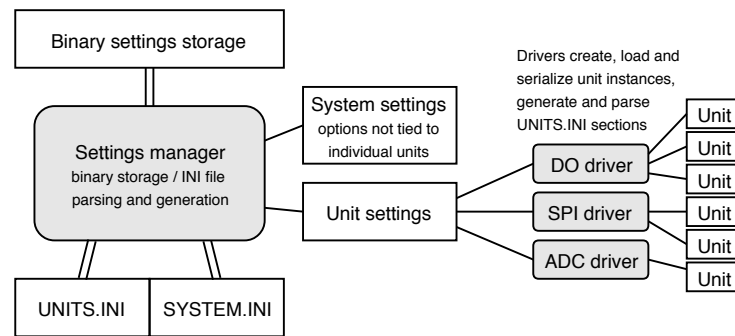

**Figure 9.2:** Structure of the settings subsystem

decides whether to use the old or new format. When the settings are next changed, the new format will be used.

The INI files, which can be edited through the communication API or using a text editor with the virtual mass storage, are parsed and generated on demand and are never stored in the Flash or RAM, other than in short temporary buffers. The INI parser processes the byte stream on-the-fly as it is received, and a similar method is used to build a INI file from the configured units and system settings.

add a sample large INI file as an attachment

## 9.5 Functional Blocks

GEX's user-facing functions, also called functional blocks or *units*, are implemented in *unit drivers*. Those are independent modules in the firmware that the user can enable and configure using the GEX configuration files. In principle, there can be multiple instances of each unit type. However, we are limited by hardware constraints: there may be only one ADC peripheral, two SPI ports and so on. The mutually exclusive assignment of resources to units is handled by the *resource registry* (9.3).

Each unit is defined by a section in the configuration file `UNITS.INI`. It is given a name and a *callsign*, which is a number that serves as an address for message delivery. A unit is internally represented by a data object with the following structure:

- Name
- Callsign
- Configuration parameters loaded from the unit settings
- State variables updated at run-time by user commands or internal functions
- A reference to the unit driver

The unit driver handles commands sent from the host PC, initializes and de-initializes the unit based on its settings, and implements other aspects of the unit's function, such as

periodic updates and interrupt handling. Unit drivers may expose public API functions to make it possible to control the unit from a different driver, allowing the creation of "macro units".

## 9.6 Source Code Layout

Looking at the source code repository (fig. 9.3), at the root we'll find device specific driver libraries and files provided by ST Microelectronics, the FreeRTOS middleware, and a folder called **User** containing the GEX application code. This division is useful when porting the firmware to a different microcontroller, as the GEX folder is mostly platform-independent and can be simply copied (of course, adjustments are needed to accompany different hardware peripheral versions etc.). The GEX core framework consists of everything in the **User** folder, excluding the **units** directory in which the individual units are implemented. Each unit driver must be registered in the file `platform.c` to be available for the user to select. The file `plat_compat.c` includes platform-specific headers and defines e.g. which pin to use for a status LED or the LOCK button.

The USB Device library, which had to be modified to support a composite class, is stored inside the **User** folder too, as it is compatible with all STM32 microcontrollers that support USB.

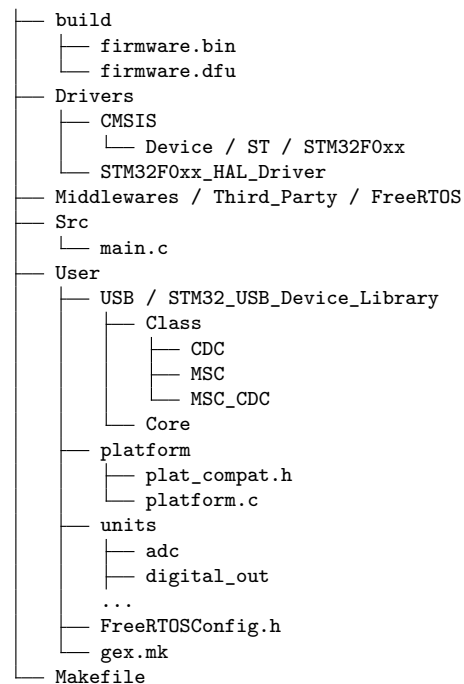

**Figure 9.3:** The general structure of the source code repository

## 9.7 Communication Ports

The firmware supports three different communication ports: hardware UART, USB (virtual serial port), and a wireless connection. Each interface is configured and accessed in a different way, but for the rest of the firmware (and for the PC-side application) they all appear as a full duplex serial port. To use interfaces other than USB, the user must configure those in the system settings (a file `SYSTEM.INI` on the configuration disk).

At start-up, the firmware enables the USB peripheral, configures the device library and waits for enumeration by the host PC. When not enumerated, it concludes the USB cable is not connected, and tries some other interface. The UART interface can't be tested as reliably, but it's possible to measure the voltage on the Rx pin. When idle, a UART Rx line should be high (here 3.3 V). The wireless module, when connected using SPI, can be detected by reading a register with a known value and comparing those.

### ■ 9.7.1 USB Connection

GEX uses vid:pid 1209:4c60 and the wireless gateway 1209:4c61. The USB interface uses the CDC/ACM USB class (4.3.2) and consists of two bulk endpoints with a payload size of up to 64 bytes.

### ■ 9.7.2 Communication UART

The parameters of the communication UART (such as the baud rate) are defined in `SYSTEM.INI`. It's mapped to pins PA2 and PA3; this is useful with STM32 Nucleo boards that don't include a User USB connector, but provide a USB-serial bridge using the on-board ST-Link programmer, connected to those pins.

This is identical to the USB connection from the PC application's side, except a physical UART is necessarily slower and does not natively support flow control. The use of the Xon and Xoff software flow control is not practical with binary messages that could include those bytes by accident, and the ST-Link USB-serial adapter does not implement hardware flow control.

### ■ 9.7.3 Wireless Connection

The wireless connection uses an on-board communication module and a separate device, a wireless gateway, that connects to the PC. The wireless gateway is interfaced differently from the GEX board itself, but it also shows as a virtual serial port on the host PC. This is required to allow communicating with the gateway itself through the CDC/ACM interface in addition to addressing the end devices.

This interface will be explained in more detail in [chapter XX](#).

Link to  
tinyframe  
descrip-  
tion

## ■ 9.8 Message Passing

One of the key functions of the core framework is to deliver messages from the host PC to the right units. This functionality resides above the framing protocol, which will be described in [chapter 10](#).

A message that is not a response in a multi-part session (this is handled by the framing library) is identified by its Type field. Two main groups of messages exist: *system messages* and *unit messages*. System messages can access the INI files, query a list of the available units, restart the module etc. Unit messages are addressed to a particular unit by their callsign (see [9.5](#)), and their payload format is defined by the unit driver. The framework reads the message type, then the callsign byte, and tries to find a matching unit in the unit list. If no unit with the callsign is found, an error response is sent back, otherwise the unit driver is given the message to handle it as required.

The framework provides one more messaging service to the units: event reporting. An asynchronous event, such as an external interrupt, an ADC trigger or an UART data reception needs to be reported to the host. This message is annotated by the unit callsign so the user application knows it's origin.



## 9.9 Interrupt Routing

Interrupts are an important part of almost any embedded application. They provide a way to rapidly react to asynchronous external or internal events, temporarily leaving the main program, jumping to an interrupt handler routine, and then returning back after the event is handled. Interrupts are also the way FreeRTOS implements multitasking without a multi-core processor.

In the Cortex-M0-based STM32F072, used in the initial GEX prototypes, the interrupt handlers table, defining which routine is called for which interrupt, is stored in the program memory and can't be changed at run-time. This is a complication for the modular structure of GEX where different unit drivers may use the same peripheral, and we would want to dynamically assign the interrupt handlers based on the active configuration. Let's have a look at an interrupt handler, in this case handling four different DMA channels, as is common in STM32 microcontrollers:

```
void DMA1_Channel4_5_6_7_IRQHandler(void)
{
    if (LL_DMA_IsActiveFlag_GI4(DMA1)) { /* handle DMA1 channel 4 */ }
    if (LL_DMA_IsActiveFlag_GI5(DMA1)) { /* handle DMA1 channel 5 */ }
    if (LL_DMA_IsActiveFlag_GI6(DMA1)) { /* handle DMA1 channel 6 */ }
    if (LL_DMA_IsActiveFlag_GI7(DMA1)) { /* handle DMA1 channel 7 */ }
}
```

It is evident that multiple units might need to use the same interrupt handler, even at the same time, since each DMA channel is configured, and works, independently. GEX implements a redirection scheme to accomplish such interrupt sharing: All interrupt handlers are defined in one place, accompanied by a table of function pointers. When a unit driver wants to register an interrupt handler, it stores a pointer to it in this redirection table. Then, once an interrupt is invoked, the common handler checks the corresponding entry in the table and calls the referenced routine, if any. Conversely, when a unit driver deinitializes a unit, it removes all interrupt handlers it used, freeing the redirection table slots for other use.



# Chapter 10

## Communication Protocol

GEX can be controlled through a hardware UART, the USB or over a wireless link. To minimize the firmware complexity, all the three connection methods are handled by the same protocol stack and are interchangeable.

The communication is organized in transactions. A transaction consists of one or more messages going in either direction. Messages can be stand-alone, or chained with a response or a follow-up message using the transaction ID. Both peers, GEX and the client application running on the PC, are equal in the communication: either side can independently initiate a transaction at any time.

GEX uses a framing library *TinyFrame*, developed likewise by the author but kept as a separate project for easier re-use in different applications. The library implements frame building and parsing, checksum calculation and a system of message listeners.

### 10.1 Frame Structure

Message frames have the following structure:

	Header					Body	
<i>Field</i>	<b>SOF</b>	<b>Frame ID</b>	<b>Payload Length</b>	<b>Frame type</b>	<b>Header checksum</b>	<b>Payload</b>	<b>Payload checksum</b>
<i>Bytes</i>	1	2	2	1	1	...	1

The field widths shown here are those used in GEX; *TinyFrame* is flexible and the data type of all fields can be customized, as well as the checksum type. The SOF byte is always 0x01.

*Frame ID*, which could be better described as *Transaction ID*, uniquely identifies each transaction. The most significant bit is set to a different value in each peer to avoid ID conflicts, and the rest of the ID field is incremented with each initiated transaction.

## 10.2 Message Listeners

After sending a message that should receive a response, the peer registers an *ID listener* with the ID of the sent message. A response reuses the original frame ID and when it is received, this listener is called to process it. ID listeners can also be used to receive multi-part messages re-using the original ID.

*Frame type* describes the payload and does not have any prescribed format; the values are defined by application (here, GEX). A *type listener* may be registered to handle all incoming messages with a given frame type. It works in a similar way to an ID listener and has a lower priority.

Each message can be handled by only one listener, unless it explicitly requests the message to be passed on to a lower priority one. Messages unhandled by any listener are given to a default listener, which can e.g. write an error to a debug log.

## 10.3 Designated Frame Types in GEX

The following table lists all frame types used by GEX. It is divided into four logical sections: General, Bulk Read/Write, Unit Access, and Settings.

Frame type	Function	Note
0x00	Success	<i>Payload depends on context</i>
0x01	Ping	<i>GEX responds with Success and its version string</i>
0x02	Error	<i>Payload contains the error message</i>
0x03	Bulk Read Offer	<i>An offer of data to read using 0x04</i>
0x04	Bulk Read Poll	<i>Requesting to read a block of data</i>
0x05	Bulk Write Offer	<i>An offer to receive a bulk write transaction</i>
0x06	Bulk Data	<i>Used for both reading and writing</i>
0x07	Bulk End	<i>Marks the last "Bulk Data" frame</i>
0x08	Bulk Abort	
0x10	Unit Request	<i>Request from PC to a unit</i>
0x11	Unit Report	<i>Spontaneous event generated by a unit</i>
0x20	List Units	<i>Read a list of all instantiated units</i>
0x21	INI Read	<i>Request a bulk read transaction of an INI file</i>
0x22	INI Write	<i>Request a bulk write transaction of an INI file</i>
0x23	Persist Config	<i>Write updated configuration to Flash</i>

## 10.4 Bulk Read and Write Transactions

The bulk read and write transactions are generic, multi-message exchanges which are used to transfer the INI configuration files. They could additionally be used by some future unit requiring to transfer a large amount of data (e.g. to read image data from a camera).

The reason for splitting a long file into multiple messages, rather than sending it all in one, lies in the hardware limitations of the platform, specifically its small amount of RAM (the STM32F072 has only 16 kB). A message cannot be processed until its payload checksum is received and verified; however, the configuration file can have several kilobytes, owing to the numerous explanatory comments, which would require a prohibitively large data buffer. The chunked transaction could, additionally, be extended to support message re-transmission on timeout without sending the entire file again.

A read or write transaction can be aborted by a frame 0x08 (Bulk Abort) at any time, though aborting a write transaction may leave the configuration in a corrupted state. As hinted in the introduction of this chapter, a transaction is defined by sharing a common frame ID. Thus, all frames in a bulk transaction must have the same ID, otherwise the ID listeners won't be called for the subsequent messages, and the transaction will time out.

Figure 10.1 shows a diagram of the bulk read and write data flow.

### 10.4.1 Bulk Read

To read an INI file, we first send a frame 0x21 (INI Read), specifying the target file in the payload:

```
struct Payload_INI_Read {
    uint8_t filename; // 0 - UNITS.INI, 1 - SYSTEM.INI
};
```

What follows is a standard bulk read transaction with the requested file. GEX offers the file for reading with a frame 0x03 (Bulk Read Offer):

```
struct Payload_BulkReadOffer {
    uint32_t total_length; // full size of the file in bytes
    uint32_t max_chunk_size; // largest chunk that can be read at once
};
```

Now we can proceed to read the file using 0x04 (Bulk Read Poll), which is always responded to with 0x06 (Bulk Data), or 0x07 (Bulk End) if this was the last frame. Data frames have only the useful data as their payload.

The 0x04 (Bulk Read Poll) payload specifies how many bytes we want to read:

```
struct Payload_BulkReadPoll {
    uint32_t max_chunk_size; // how many bytes to read
};
```

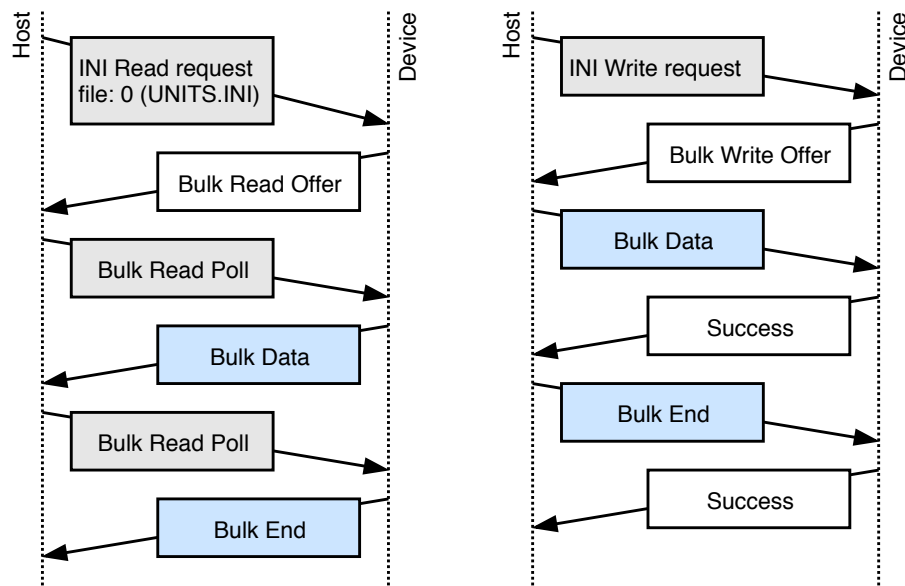

Figure 10.1: A diagram of the bulk read and write transaction.

### 10.4.2 Bulk Write

To overwrite an INI file, we first send a frame 0x22 (INI Write), specifying its size in the payload. Which file is written is detected automatically from the first INI section.

```
struct Payload_INI_Write {
    uint32_t total_length; // file size in bytes
};
```

The write request is confirmed by a frame 0x05 (Bulk Write Offer):

```
struct Payload_BulkWriteOffer {
    uint32_t total_length; // the expected file size in bytes
    uint32_t max_chunk_size; // largest chunk that can be written at once
};
```

We can now send the file as a series of frames 0x06 (Bulk Data), or 0x07 (Bulk End) in the last frame. Each written chunk is confirmed by 0x00 (Success).

### 10.4.3 Persisting the Changed Configuration to Flash

The written INI file is immediately parsed and the settings are applied. However, those changes are not persistent: they exist only in RAM and will be lost when the module restarts. To save the current state to Flash, issue a frame 0x23 (Persist Config). This has the same effect as pressing the LOCK button (or replacing the LOCK jumper) when the INI files are edited using the virtual mass storage.

It should be noted that after flashing a firmware, the Flash control registers may remain in an unexpected state and the module must first be manually restarted before attempting to persist settings. Otherwise an assertion will fail and the module is restarted by a watchdog, losing the temporary changes.

## 10.5 Reading a List of Units

The frame 0x20 (List Units) requests a list of all available units in the GEX module. The list includes all units' callsigns, names and types. The response payload has the following format (in pseudocode, as it can't be expressed as a C struct like the previous examples):

```
struct {
    uint8_t count;
    for all units {
        uint8_t callsign;
        cstring unit_name; // 0-terminated char array
        cstring driver_name;
    }
}
```

## 10.6 Unit Requests and Reports

Frame types 0x10 (Unit Request) and 0x11 (Unit Report) are dedicated to messages sent to and by unit instances. Each has a fixed header (*inside the payload*) followed by unit-specific data.

### 10.6.1 Unit Requests

Unit requests deliver a message from the host to a unit instance. Unit drivers implements different commands, each with its own payload structure. The frame 0x10 (Unit Request) has the following structure:

```
struct Payload_UnitRequest {
    uint8_t callsign;
    uint8_t command; // handled by the unit driver
    uint8_t payload[]; // size and content depend on the command
};
```

The most significant bit of the command byte (0x80) has a special meaning: when set, the message delivering routine responds with 0x00 (Success) after the command completes, unless an error occurred. That is used to get a confirmation that the message was delivered and the module operates correctly (as opposed to e.g. a lock-up resulting in a watchdog reset). Requests which normally generate a response (e.g. reading a value from the unit) should not be sent with this bit set. As a result of this special treatment of the highest bit, there can be only 127 different commands per unit.

## 10.6.2 Unit Reports

Several unit types can produce asynchronous events, such as reporting a pin change or a triggering condition. The event is timestamped and sent with a frame type 0x11 (Unit Report):

```
struct Payload_UnitRequest {
    uint8_t callsign;
    uint8_t report_type; // defines the payload structure
    uint64_t timestamp; // microseconds since power-on
    uint8_t payload[]; // size and content depend on the report type
};
```



# Chapter 11

## Wireless Interface

Four methods of a wireless connection have been considered: Bluetooth (e.g. with CC2541), WiFi with ESP8266, LoRA or GFSK-modulated 868 MHz link with SX1276, and a 2.4 GHz link with nRF24L01+. Bluetooth was dismissed early for its complexity and ESP8266 for its high consumption in continuous reception mode, although both solutions might be viable for certain applications and with more time for evaluation.

The Semtech SX1276 and Nordic Semiconductor nRF24L01+ transceivers have both been tested using the first GEX prototype, confirming its usefulness as a hardware development tool, and it's been confirmed they could fulfill the requirements of the application.

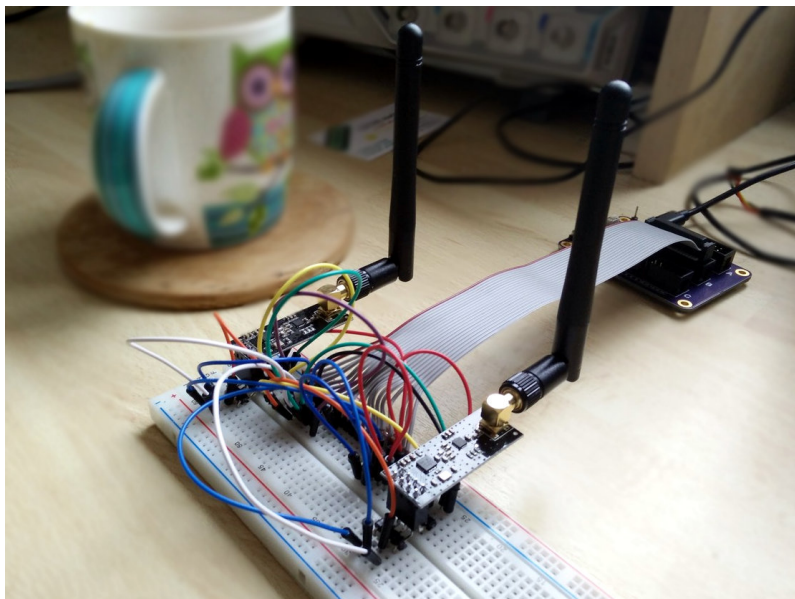

**Figure 11.1:** Test setup with a GEX prototype controlling two nRF24L01+ modules

### 11.1 Comparing SX1276 vs. nRF24L01+

The two transceivers are compared in table 11.1. It's apparent that each has its strengths and weaknesses.

SX1276 supports additional modulation modes, including a proprietary LoRa scheme with a frequency-hopping spread spectrum modulation that can be received at a distance up

Parameter	SX1276	nRF24L01+
Connection	SPI (4 pins) + up to 6 IRQ	SPI (4 pins), CE, IRQ
Frequency band	868 MHz or 433 MHz	2.4 GHz
Data rate	up to 300 kbps	250–2000 kbps
Modulation	(G)FSK, (G)MSK, OOK, LoRa	GFSK
Range (est.)	2 km to 20 km LOS	up to 1 km LOS
Consumption Rx	10.8–12 mA	12.6–13.5 mA
Consumption Tx	20–120 mA	7–11.3 mA
Idle power (max)	1 $\mu$ A sleep, 2 mA stand-by	0.9 $\mu$ A sleep, 320 $\mu$ A stand-by
Max packet size	300 bytes	32 bytes
Reset	NRESET pin	Vdd disconnect
Extra	LoRa FHSS, packet engine	ShockBurst protocol engine
Price	\$7.3	\$1.6

**Table 11.1:** Comparison of the SX1276 and nRF24L01+ wireless transceivers (price from DigiKey @ 10 pieces, May 6th 2018)

to 20 km in ideal conditions. The long-range capability is reflected in a higher consumption during transmission. However, its consumption in receiver mode is slightly lower than that of the nRF24L01+.

nRF24L01+ provides higher data rates at short distances. Its power consumption is comparable or lower than that of the SX1276. It lacks a dedicated reset pin, but that can be easily worked around using an external transistor to momentarily disconnect its Vdd pin.

Both devices implement some form of a packet engine with error checking; that of the nRF24L01+, called ShockBurst, is more advanced as it implements acknowledgment responses and automatic re-transmission, leading to a potentially more robust communication without an additional overhead on the side of the microcontroller.

## 11.2 Integration of the nRF24L01+ into GEX

The nRF24L01+ was selected to be integrated into GEX thanks to its inclusion of the ShockBurst engine, higher possible data rates and significantly lower price. The SX1276, nonetheless, remains an interesting option that could be used as an alternative in the future, should the need for a long range communication arise.

A separate device, the *GEX wireless gateway*, was developed to provide the PC connection to a nRF24L01+ module. It is based on the STM32F103 microcontroller in its smallest package (LQFP48), selected for its low cost and good availability.

### 11.2.1 The Wireless Gateway Protocol

The gateway presents itself to the host as a CDC/ACM device, much like the GEX modules themselves (here called *nodes*) when connected over USB. It implements a simple protocol which encapsulates the binary data sent to or from a connected node. The wrapped GEX protocol (chapter 10) remains unchanged.

The gateway has a 4-byte network ID, a number derived from the microcontroller’s unique ID. The network ID must be entered into all nodes that wish to communicate with it. Additionally, each module must be assigned a unique 1-byte number, which, together with the four network ID bytes, uniquely identifies the node. The gateway can connect to up to 6 nodes at once.

All messages sent to or from the gateway are a multiple of 64 bytes long, padded with zeros if shorter. The message starts with a control byte, determining the message type (table 11.2).

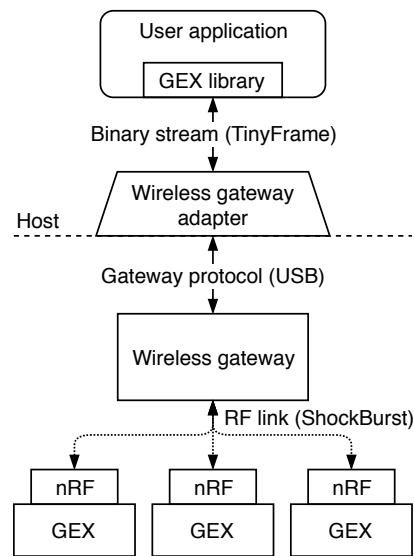

**Figure 11.2:** A block diagram of the wireless connection

Function	Message structure
Send a message	'm' (u8)address (u16)length (u8[])payload
Restart & remove nodes	'r'
Add nodes	'n' (u8)count (u8[])addresses
Get the network ID	'i'
Response to 'i'	0x01 (u8[4])net_id
Received message	0x02 (u8)address (u8)length (u8[])data

**Table 11.2:** Wireless gateway commands and messages; control characters in the printable range are shown as ASCII

The gateway may be restarted using the 'r' command when the PC application starts. Then it adds all node addresses with the 'n' command and can begin communication. The 'i' command, reading the network ID, can additionally be used as a ping command to verify the USB connection.

Add additional commands. Also remove magic bytes from the real messages, they're useless



# Chapter 12

## Units Overview and API

This chapter describes all functional blocks (units) implemented in GEX at the time of publication of this work. Each unit supports a different set of binary commands and events. The term "unit" will be used to refer to both unit types (drivers) or their instances, where the distinction is not important.

Each unit's description will be accompanied by a corresponding snippet from the configuration file, and a list of supported commands and events. When the command's request payload is empty, it's omitted from the table. The same applies to commands with no response, in which case adding 0x80 to the command number triggers a SUCCESS response if the command succeeds.

### 12.1 Naming Conventions and Common Principles

#### 12.1.1 Unit Naming

Unit types are named in uppercase (e.g. SPI, 1WIRE, NPX) in the INI file and in the list of units. Unit instances can be named in any way the user desires; Using lowercase makes it easier to distinguish them from unit types. It is advisable to use descriptive names, e.g. not "pin1" but rather "button".

#### 12.1.2 Packed Pin Access

Several units facilitate an access to a group of GPIO pins, such as the digital input and output units, or the SPI unit's slave select pins. The STM32 microcontroller's ports have 16 pins each, most of which can be configured to one of several alternate functions (e.g. SPI, PWM outputs, ADC input). As a consequence, it's common to be left with a discontinuous group of pins after assigning all the alternate functions needed by an application.

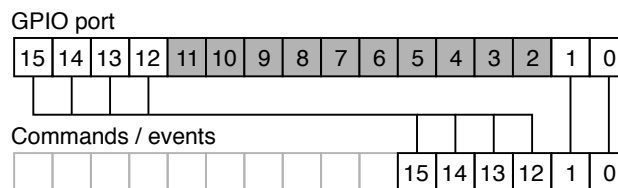

Figure 12.1: Pin packing

For instance, we could only have the pins 0, 1, 12–15 available on a GPIO port. GEX provides a helpful abstraction to bridge the gaps in the port: The selected pins are packed together and represented, in commands and events, as a block of six pins (0x3F) instead of their original positions in the register (0xF003). This scheme is shown in figure 12.1. The translation is done in the unit driver and works transparently, as if the block of pins had no gaps—all the referenced pins are updated simultaneously without glitches. Where pin numbers are used, the order in the packed word should be provided—in our example, that would be 0–5, counting from the least significant bit.

## 12.2 DO: Digital Output

The digital output unit provides a write access to one or more pins of a GPIO port. This unit additionally supports pulse generation on any of its pins. This is implemented in software with the timing derived from the system timebase, as the hardware timer outputs, otherwise used for PWM or pulse generation, are available only on several dedicated pins. The timing code is optimized to reduce jitter.

Measure jitter and add it here

### 12.2.1 DO Configuration

```
[DO:out@1]
# Port name
port=A
# Pins (comma separated, supports ranges)
pins=0
# Initially high pins
initial=
# Open-drain pins
open-drain=
```

### 12.2.2 DO Events

This unit generates no events.

### 12.2.3 DO Commands

Code	Name	Function	Payload
0x00	WRITE	Write to all pins	<i>Request</i> • u16: new value
0x01	SET	Set selected pins to 1	<i>Request</i> • u16: pins to set
0x02	CLEAR	Set selected pins to 0	<i>Request</i> • u16: pins to clear
0x03	TOGGLE	Toggle selected pins	<i>Request</i> • u16: pins to toggle
0x04	PULSE	Generate a pulse on the selected pins. The $\mu\text{s}$ scale may be used only for 0–999 $\mu\text{s}$ .	<i>Request</i> • u16: pins to pulse • u8: active level (0, 1) • u8: scale: 0-ms, 1- $\mu\text{s}$ • u16: duration

## 12.3 DI: Digital Input

The digital input unit is the input counterpart of the digital output unit.

In addition to reading the immediate digital levels of the selected pins, this unit can generate asynchronous events on a pin change. The state of the entire input port, together with a microsecond timestamp (as is the case for all asynchronous events), is reported to the host either on a rising, falling, or any pin change.

The pin change event can be configured independently for each pin. In order to receive a pin change event, it must be armed first; The pin can be armed for a single event, or it may be re-armed automatically with a hold-off time. It's further possible to automatically arm selected pin triggers on start-up.

### 12.3.1 DI Configuration

```
[DI:in02]
# Port name
port=A
# Pins (comma separated, supports ranges)
pins=0
# Pins with pull-up
pull-up=
# Pins with pull-down
pull-down=
```

```
# Trigger pins activated by rising/falling edge
trig-rise=
trig-fall=
# Trigger pins auto-armed by default
auto-trigger=
# Triggers hold-off time (ms)
hold-off=100
```

### 12.3.2 DI Events

Code	Name	Meaning	Payload
0x00	PIN_CHANGE	A pin change event. The payload includes a snapshot of all configured pins captured immediately after the change was registered.	<ul style="list-style-type: none"> <li>• u16: changed pins</li> <li>• u16: port snapshot</li> </ul>

### 12.3.3 DI Commands

Code	Name	Function	Payload
0x00	READ	Read the pins	<i>Response</i> <ul style="list-style-type: none"> <li>• u16: pin states</li> </ul>
0x01	ARM_SINGLE	Arm for a single event	<i>Request</i> <ul style="list-style-type: none"> <li>• u16: pins to arm</li> </ul>
0x02	ARM_AUTO	Arm with automatic re-arming after each event	<i>Request</i> <ul style="list-style-type: none"> <li>• u16: pins to arm</li> </ul>
0x03	DISARM	Dis-arm selected pins	<i>Request</i> <ul style="list-style-type: none"> <li>• u16: pins to dis-arm</li> </ul>

## 12.4 SIPO: Shift Registers Driver

The shift registers driver unit is designed for the loading of data into *serial-in, parallel-out* (SIPO) shift registers, such as 74HC4094 or 74HC595. Those are commonly used to control segmented LED displays, LED matrices etc.

This unit handles both the *Shift* and *Store* signals and is capable of loading multiple shift registers simultaneously, reducing visible glitches in the display. It's also possible to set the data lines to arbitrary level(s) before sending the Store pulse, which can be latched and used for some additional feature of the LED display, such as brightness control.



### 12.4.1 SIPO Configuration

```
[SIPO:display@9]
# Shift pin & its active edge (1-rising,0-falling)
shift-pin=A1
shift-pol=1
# Store pin & its active edge
store-pin=A0
store-pol=1
# Clear pin & its active level
clear-pin=A2
clear-pol=0
# Data port and pins
data-port=A
data-pins=3
```

### 12.4.2 SIPO Events

This unit generates no events.

### 12.4.3 SIPO Commands

Code	Name	Function	Payload
0x00	WRITE	Load the shift registers and leave the data outputs in the "trailing data" state before sending the Store pulse.	<i>Request</i> <ul style="list-style-type: none"> <li>• u16: trailing data</li> <li>• For each output: <ul style="list-style-type: none"> <li>◦ u8[]: data to load</li> </ul> </li> </ul>
0x01	DIRECT_DATA	Directly write to the data pins (same like the DO unit's WRITE command)	<i>Request</i> <ul style="list-style-type: none"> <li>• u16: values to write</li> </ul>
0x02	DIRECT_CLEAR	Pulse the Clear pin, erasing the registers' data	
0x03	DIRECT_SHIFT	Pulse the Shift pin	
0x04	DIRECT_STORE	Pulse the Store pin	

## 12.5 NPX: NeoPixel

The NeoPixel unit implements the protocol needed to control a digital LED strip with WS2812, WS2811, or compatible LED driver chips. The protocol timing is implemented in software, therefore it is available on any GPIO pin of the module.

The color data can be loaded in five different format: as packed bytes, or as the little-endian or big-endian encoding of colors in the 32-bit format 0x00RRGGBB or 0x00BBGRR. This data format is convenient when the colors are already represented by an array of 32-bit integers.

### 12.5.1 NPX Configuration

```
[NPX:neo@3]
# Data pin
pin=A0
# Number of pixels
pixels=32
```

### 12.5.2 NPX Events

This unit generates no events.

### 12.5.3 NPX Commands

Code	Name	Function	Payload
0x00	CLEAR	Switch all LEDs off (sets them to black)	
0x01	LOAD	Load a sequence of R,G,B bytes	<i>Request</i> <ul style="list-style-type: none"> <li>For each LED: <ul style="list-style-type: none"> <li>u8: red</li> <li>u8: green</li> <li>u8: blue</li> </ul> </li> </ul>
0x08	LOAD_U32_ZRGB	Load 32-bit big-endian 0xRRGGBB (0,R,G,B)	<i>Request</i> <ul style="list-style-type: none"> <li>u32 []: color data BE</li> </ul>
0x09	LOAD_U32_ZBGR	Load 32-bit big-endian 0xBBGRR (0,B,G,R)	<i>Request</i> <ul style="list-style-type: none"> <li>u32 []: color data BE</li> </ul>
0x0A	LOAD_U32_RGBZ	Load 32-bit little-endian 0xBBGRR (R,G,B,0)	<i>Request</i> <ul style="list-style-type: none"> <li>u32 []: color data LE</li> </ul>
0x0B	LOAD_U32_BGRZ	Load 32-bit little-endian 0xRRGGBB (B,G,R,0)	<i>Request</i> <ul style="list-style-type: none"> <li>u32 []: color data LE</li> </ul>
0x10	GET_LEN	Get number of LEDs in the strip	<i>Response</i> <ul style="list-style-type: none"> <li>u16: number of LEDs</li> </ul>

## 12.6 SPI Unit

The SPI unit provides access to one of the microcontroller's SPI peripherals. It can be configured to use any of the different speeds, clock polarity and phase settings available in its control registers.

The unit handles up to 16 slave select (NSS) signals and supports message multi-cast (addressing more than one slaves at once). Protection resistors should be used if a multi-cast transaction is issued with MISO connected.

The QUERY command of this unit, illustrated by figure 12.2, is flexible enough to support all types of SPI transactions: read-only, write-only, and read-write with different request and response lengths. The slave select pin is held low during the entire transaction.

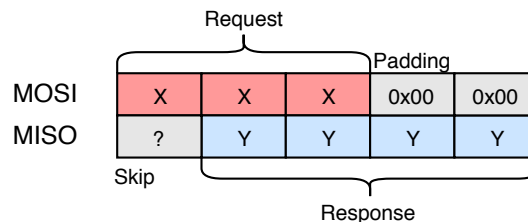

Figure 12.2: SPI transaction using the QUERY command

### 12.6.1 SPI Configuration

```
[SPI:spi05]
# Peripheral number (SPIx)
device=1
# Pin mappings (SCK,MISO,MOSI)
# SPI1: (0) A5,A6,A7      (1) B3,B4,B5
# SPI2: (0) B13,B14,B15
remap=0
# Prescaler: 2,4,8,...,256
prescaler=64
# Clock polarity: 0,1 (clock idle level)
cpol=0
# Clock phase: 0,1 (active edge, 0-first, 1-second)
cpha=0
# Transmit only, disable MISO
tx-only=N
# Bit order (LSB or MSB first)
first-bit=MSB
# SS port name
port=A
# SS pins (comma separated, supports ranges)
pins=0
```

## 12.6.2 SPI Events

This unit generates no events.

## 12.6.3 SPI Commands

Code	Name	Function	Payload
0x00	QUERY	Exchange bytes with a slave device	<i>Request</i> <ul style="list-style-type: none"> <li>• u8: slave number 0–16</li> <li>• u16: response padding</li> <li>• u16: response length</li> <li>• u8[]: bytes to write</li> </ul> <i>Response</i> <ul style="list-style-type: none"> <li>• u8[]: received bytes</li> </ul>
0x01	MULTICAST	Send a message to multiple slaves at once. The address is a bit map (e.g. 0x8002 = slaves 1 and 15).	<i>Request</i> <ul style="list-style-type: none"> <li>• u16: addressed slaves</li> <li>• u8[]: bytes to write</li> </ul>

## 12.7 I2C Unit

The I2C unit provides access to one of the microcontroller’s I2C peripherals. It can be configured to use either of the three speeds (Standard, Fast and Fast+) and supports both 10-bit and 7-bit addressing. 10-bit addresses can be used in commands by setting their highest bit (0x8000) as a flag.

### 12.7.1 I2C Configuration

```
[I2C:d@4]
# Peripheral number (I2Cx)
device=1
# Pin mappings (SCL,SDA)
# I2C1: (0) B6,B7 (1) B8,B9
# I2C2: (0) B10,B11 (1) B13,B14
remap=0

# Speed: 1-Standard, 2-Fast, 3-Fast+
speed=1
# Analog noise filter enable (Y,N)
analog-filter=Y
# Digital noise filter bandwidth (0-15)
digital-filter=0
```

### 12.7.2 I2C Events

This unit generates no events.

### 12.7.3 I2C Commands

Code	Name	Function	Payload
0x00	WRITE	Raw write transaction	<i>Request</i> <ul style="list-style-type: none"> <li>• u16: slave address</li> <li>• u8[]: bytes to write</li> </ul>
0x01	READ	Raw read transaction	<i>Request</i> <ul style="list-style-type: none"> <li>• u16: slave address</li> <li>• u16: number of read bytes</li> </ul> <i>Response</i> <ul style="list-style-type: none"> <li>• u8[]: received bytes</li> </ul>
0x02	WRITE_REG	Write to a slave register. Sends the register number and the data in the same I2C transaction. Multiple registers can be written to slaves supporting auto-increment.	<i>Request</i> <ul style="list-style-type: none"> <li>• u16: slave address</li> <li>• u8: register number</li> <li>• u8[]: bytes to write</li> </ul>
0x03	READ_REG	Read from a slave register. Writes the register number and issues a read transaction of the given length. Multiple registers can be read from slaves supporting auto-increment.	<ul style="list-style-type: none"> <li>• u16: slave address</li> <li>• u8: register number</li> <li>• u16: number of read bytes</li> </ul> <i>Response</i> <ul style="list-style-type: none"> <li>• u8[]: received bytes</li> </ul>

## 12.8 USART Unit

The USART unit provides access to one of the microcontroller's USART peripherals. All USART parameters can be configured to match the application's needs.

The clock output and hardware flow control may be enabled, as well as the Driver Enable (DE) output used by RS485 transceivers to switch between a reception and transmission mode.

## 12.9 1-Wire Unit

The 1-Wire unit implements the Dallas Semiconductor's 1-Wire protocol, most commonly used to interface smart thermometers (DS18x20). The protocol is explained in section 7.4.

This unit implements the basic protocol, as well as the ROM Search algorithm used to recognize all unique 1-Wire devices connected to the bus.

## 12.10 Frequency Capture Unit

The frequency capture unit implements both the frequency measurement methods explained in section 8.1: direct and reciprocal. It can be operated in an on-demand or continuous measurement mode. The unit can be switched to two other modes: pulse counter, and the measurement of a single pulse.

## 12.11 ADC Unit

The analog/digital converter unit is one of the most complicated units implemented in the project. The unit can measure the voltage on an input pin, either as its immediate value, or averaged with exponential forgetting. Isochronous sampling is available as well: It's possible to capture a fixed-length block of data on demand, or as a response to a triggering condition on any of the enabled input pins. The ADC must continuously sample the inputs to make the averaging and level based triggering possible; As a consequence, a pre-trigger buffer is available that can be read together with the block of samples following a trigger. The ADC unit can also be switched to a continuous streaming mode.

It's possible to activate any number of the 16 analog inputs of the ADC peripheral simultaneously. The maximum continuous sampling frequency, which reaches 70 ksp/s with one channel, lowers with an increasing number of enabled channels as the amount of data to transfer to the host increases.

## 12.12 DAC Unit

The digital/analog unit works with the two-channel DAC peripheral of the microcontroller. It can be used in two modes: DC output, and waveform generation.

The waveform mode implements direct digital synthesis (explained in section 8.3.2) of a sine, rectangle, sawtooth or triangle wave. The generated frequency can be set with a sub-hertz precision up to the lower tens of kHz. The two outputs can use a different waveform shape, be synchronized, and their phase offset, as well as frequency, is dynamically adjustable.

## 12.13 PWM Unit

The PWM unit uses a timer/counter to generate a PWM signal. There are four outputs with a common frequency and phase, but independent duty cycles. Each channel can be individually enabled or disabled.

This unit is intended for applications like light dimming, heater regulation, or the control of H-bridges.

## ■ 12.14 Touch Sensing Unit

The touch sensing unit provides an access to the touch sensing controller. Its function is explained in section 8.4. The unit configures the TSC and reads the output values of each enabled touch pad.







## Appendices

