

Master Thesis

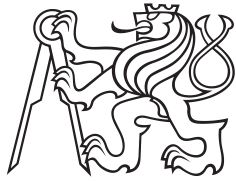

**Czech
Technical
University
in Prague**

F3

**Faculty of Electrical Engineering
Department of Measurement**

Learning and automation GPIO platform

Bc. Ondřej Hruška

**Supervisor: doc. Ing. Radislav Šmíd, Ph.D.
Field of study: Cybernetics and Robotics
Subfield: Sensors and Instrumentation
2018**



MASTER'S THESIS ASSIGNMENT

I. Personal and study details

Student's name: **Hruška Ondřej** Personal ID number: **420010**
Faculty / Institute: **Faculty of Electrical Engineering**
Department / Institute: **Department of Measurement**
Study program: **Cybernetics and Robotics**
Branch of study: **Sensors and Instrumentation**

II. Master's thesis details

Master's thesis title in English:

Learning and Automation GPIO Platform

Master's thesis title in Czech:

Výuková a automatizační GPIO platforma

Guidelines:

Design and implement a modular system consisting of a motherboard and additional modules for connecting sensors, actuators and general inputs via I2C, SPI, UART, 1-Wire or other interfaces to the central system via USB, UART, and wireless interfaces. Allow access to built-in processor peripherals such as ADC, DAC, and timers (PWM, frequency measurement). Design a comfortable way to set the configuration without firmware changes. For the designed system, create a service library in C, Python, and MATLAB.

Bibliography / sources:

- [1] STMicroelectronics datasheets, <http://www.st.com>
- [2] Ganssle, J.: The Art of Designing Embedded Systems, Elsevier Science, 2008.
- [3] Chi, Qingping & Yan, Hairong & Zhang, Chuan & Pang, Zhibo & Da Xu, Li. (2014).: A Reconfigurable Smart Sensor Interface for Industrial WSN in IoT Environment. Industrial Informatics, IEEE Transactions on. 10. 1417-1425. 10.1109/TII.2014.2306798.

Name and workplace of master's thesis supervisor:

doc. Ing. Radislav Šmíd, Ph.D., Department of Measurement, FEL

Name and workplace of second master's thesis supervisor or consultant:

Date of master's thesis assignment: **10.01.2018** Deadline for master's thesis submission: _____

Assignment valid until:
by the end of summer semester 2018/2019

doc. Ing. Radislav Šmíd, Ph.D.
Supervisor's signature

Head of department's signature

prof. Ing. Pavel Ripka, CSc.
Dean's signature

III. Assignment receipt

The student acknowledges that the master's thesis is an individual work. The student must produce his thesis without the assistance of others, with the exception of provided consultations. Within the master's thesis, the author must state the names of consultants and include a list of references.

Date of assignment receipt

Student's signature

Declaration

Prohlašuji, že jsem předloženou práci vypracoval samostatně a že jsem uvedl veškeré použité informační zdroje v souladu s Metodickým pokynem o dodržování etických principů při přípravě vysokoškolských závěrečných prací.

V Praze, 25. května 2018

.....

Foreword

Before you lies the work of many long days and sleepless nights, the result of years of study and planning. This work is released to the commons as a payback for the many open-source projects that allowed it to become what it has.

I would like to thank my tutors for the knowledge, and to my friends for the encouragement to pull this off and create something I can be proud of.

Special thanks go to:

- Annie, for showing me Draw.io, and its developers, for building a great and free diagram drawing tool.
- Beatrix, for keeping a friendly server where I could hang out in the breaks between writing.
- Cpsdq and others who helped with proofreading.
- TeXstudio developers, the TeX.StackExchange.com community, and CTAN contributors, without whom this paper would have been much harder to write.

May the project prosper and be helpful to many.

Ondřej Hruška

Prague, May 21, 2018

Abstract

This thesis documents the development of a universal software and hardware platform providing high-level user applications running on a PC with access to GPIO pins, hardware buses, and signal acquisition and generation functions, using a USB, USART, or wireless connection.

The requirements of common engineering tasks and problems occurring in the university environment were evaluated to design an extensible, reconfigurable hardware module that would make a versatile and low-cost tool that in some cases eliminates the need for professional measurement and testing equipment.

We designed custom hardware modules, an extensible microcontroller firmware, and PC support libraries for programming languages C and Python. The Python library may further be used in MATLAB scripts. The devices provide access to hardware buses (I²C, SPI, USART, and 1-Wire) and microcontroller peripherals (GPIO, ADC, and DAC), implement frequency measurement and other useful features. They are configured in INI files accessed through on a virtual USB mass storage device, or programmatically.

Keywords: STM32, hardware design, electronics, embedded, automation, USB, data acquisition, gateway, wireless

Supervisor: doc. Ing. Radislav Šmíd, Ph.D.

Abstrakt

Tato práce popisuje vývoj univerzální softwarové a hardwarové platformy pro přístup k hardwarovým sběrnicím a elektrickým obvodům z prostředí vysokoúrovňových programovacích jazyků a aplikací běžících na PC, a to za využití USB, UARTU a také bezdrátově.

Byly vyhodnoceny požadavky typických problémů vyskytujících se při práci s vestavěnými systémy a ve výuce za účelem návrhu snadno rozšiřitelného a přenastavitelného hardwarového modulu který bude praktickým, pohodlným a dostupným nástrojem, který navíc v některých případech může nahradit profesionální laboratorní přístroje.

Bylo navrženo několik prototypů hardwarových modulů spolu s obslužnými knihovnami v jazycích C a Python; Python knihovnu lze dále používat z prostředí MATLAB. Navržené moduly umožňují přístup k většině běžných hardwarových sběrnic (I²C, SPI, USART, 1-Wire) a umožňuje také např. měřit frekvenci a vzorkovat či generovat analogové signály.

Klíčová slova: STM32, hardware, vestavěné systémy, elektronika, automatizace, USB, sběr dat

Překlad názvu: Výuková a automatizační GPIO platforma

Contents

Part I Introduction

1 Motivation	3
1.1 Expected Outcome	4
2 Requirement Analysis	5
2.1 Desired Features	5
2.1.1 Interfacing Intelligent Modules	5
2.1.2 Analog Signal Acquisition	6
2.1.3 Analog Signal Output	6
2.1.4 Logic Level Input and Output	6
2.1.5 Pulse Generation and Measurement	6
2.2 Connection to the Host Computer	7
2.2.1 Communication Interface	7
2.2.2 Configuration Files	7
2.3 An Overview of Planned Features	7
2.4 Microcontroller Selection	8
2.5 Form Factor Considerations	8
3 Existing Solutions	11
3.1 Raspberry Pi	11
3.2 Bus Pirate	12
3.3 Professional DAQ Modules	12

Part II Theoretical Background

4 Universal Serial Bus	17
4.1 Basic Principles and Terminology	17
4.1.1 Pipes and Endpoints	17
4.1.2 Transfer Types	18
4.1.3 Interfaces and Classes	18
4.1.4 Descriptors	19
4.2 USB Physical Layer	21

4.3 USB Classes	22
4.3.1 Mass Storage Class	22
4.3.2 CDC/ACM Class	22
4.3.3 Interface Association: Composite Class	23
5 FreeRTOS	25
5.1 Basic FreeRTOS Concepts and Functions	25
5.1.1 Tasks	25
5.1.2 Synchronization Objects	26
5.2 Stack Overflow Protection	27
6 The FAT16 File System and Its Emulation	29
6.1 The General Structure of the FAT File System	29
6.1.1 Boot Sector	30
6.1.2 File Allocation Table	30
6.1.3 Root Directory	30
6.2 FAT16 Emulation	32
6.2.1 DAPLink Emulator	32
6.2.2 Read Access	32
6.2.3 Write Access	33
6.2.4 File Name Change	33
6.2.5 File Creation	34
6.2.6 File Content Change	34
7 Supported Hardware Buses	35
7.1 UART and USART	35
7.1.1 Examples of Devices Using UART	36
7.2 SPI	36
7.2.1 Examples of Devices Using SPI	37
7.3 I ² C	38
7.3.1 Examples of Devices Using I ² C	39
7.4 1-Wire	39
7.4.1 Examples of Devices Using 1-Wire	40

7.5 NeoPixel	40
8 Non-communication Hardware Functions	43
8.1 Frequency Measurement	43
8.2 Analog Signal Acquisition	45
8.3 Waveform Generation	46
8.3.1 Waveform Generation with DMA and a Timer	46
8.3.2 Direct Digital Synthesis	47
8.4 Touch Sensing	48
Part III	
Implementation	
9 Conceptual Overview	53
9.1 Physical User Interface	54
9.2 GEX-PC Connection	54
9.3 Controlling GEX	55
9.4 Device Configuration	56
9.4.1 INI File Format	56
9.4.2 Configuration Files Structure	56
10 Internal Application Structure	61
10.1 Internal Structure Block Diagram	62
10.2 Unit Life Cycle and Internal Structure	62
10.3 Resource Allocation	63
10.4 Settings Storage	63
10.5 Message Passing	64
10.6 Interrupt Routing	64
10.7 FreeRTOS Synchronization Objects Usage	65
10.7.1 Message and Job Queue	65
10.7.2 Lock Objects	65
11 Working with the GEX Source Code	67
11.1 Porting to a New Platform	67

12 Communication Protocol	71
12.1 Binary Payload Structure Notation	71
12.2 Frame Structure	72
12.3 Message Listeners	72
12.4 Designated Frame Types	72
12.5 Bulk Read and Write Transactions	73
12.5.1 Bulk Read	74
12.5.2 Bulk Write	74
12.5.3 Persisting the Changed Configuration to Flash	75
12.6 Reading the List of Units	75
12.7 Unit Requests and Reports	76
12.7.1 Unit Requests	76
12.7.2 Unit Reports	76
13 Units Overview, Commands and Events Description	79
13.1 General Notes	79
13.1.1 Unit Naming	79
13.1.2 Packed Pin Access	79
13.2 Digital Output	80
13.2.1 Digital Output Configuration	80
13.2.2 Digital Output Commands	80
13.3 Digital Input	81
13.3.1 Digital Input Configuration	81
13.3.2 Digital Input Events	82
13.3.3 Digital Input Commands	82
13.4 SIPO (Shift Register) Unit	82
13.4.1 SIPO Configuration	83
13.4.2 SIPO Commands	83
13.5 NeoPixel Unit	84
13.5.1 NeoPixel Configuration	84
13.5.2 NeoPixel Commands	84
13.6 SPI Unit	85

13.6.1 SPI Configuration	85
13.6.2 SPI Commands	86
13.7 I ² C Unit	86
13.7.1 I ² C Configuration	87
13.7.2 I ² C Commands	87
13.8 USART Unit	88
13.8.1 USART Configuration	88
13.8.2 USART Events	89
13.8.3 USART Commands	89
13.9 1-Wire Unit	90
13.9.1 1-Wire Configuration	90
13.9.2 1-Wire Commands	90
13.10 Frequency Capture Unit	91
13.10.1 Value Conversion Formulas	91
13.10.2 Frequency Capture Configuration	92
13.10.3 Frequency Capture Commands	92
13.11 ADC Unit	94
13.11.1 ADC Configuration	95
13.11.2 ADC Events	96
13.11.3 ADC Commands	96
13.12 DAC Unit	98
13.12.1 DAC Configuration	98
13.12.2 DAC Commands	98
13.13 PWM Unit	100
13.13.1 PWM Configuration	100
13.13.2 PWM Commands	100
13.14 Touch Sense Unit	101
13.14.1 Touch Sense Configuration	101
13.14.2 Touch Sense Events	102
13.14.3 Touch Sense Commands	102

14 Wireless Interface	103
14.1 Modulations Overview	103
14.1.1 On-Off Keying (OOK)	103
14.1.2 Frequency Shift Keying (FSK)	104
14.1.3 Gaussian Frequency Shift Keying (GFSK)	104
14.1.4 Minimum-Shift Keying (MSK)	104
14.1.5 Gaussian Minimum-Shift Keying (GMSK)	104
14.1.6 LoRa Modulation	104
14.2 Comparing SX1276 and nRF24L01+	104
14.3 Wireless Link with the nRF24L01+	105
14.3.1 The Wireless Gateway	106
14.3.2 The Gateway Protocol	106
14.3.3 Gateway Initialization Procedure	107
15 Hardware Realization	109
15.1 GEX on a STM32 Discovery Board	109
15.1.1 Discovery STM32F072 Configuration and Pin Mapping	109
15.2 GEX Hub	110
15.2.1 GEX Hub Errata	110
15.3 GEX Zero	111
15.3.1 Pin Assignment	112
15.4 GEX Zero Errata	113
15.5 Wireless Gateway	113
16 Client Software	117
16.1 General Library Structure	117
16.2 Python Library	117
16.2.1 Example Python Script	118
16.3 MATLAB integration	118
16.4 C Library	119
16.4.1 Structure-based Payload Construction	120
16.4.2 Using the Payload Builder Utility	120

Part IV Results

17 Example Applications	127
17.1 Frequency Response Measurement	127
17.2 Measuring CO ₂ Concentration	128
17.3 Controlling the “Micro Dot pHAT”	129
17.4 Capturing Transient Effects	129
18 Discussion	133
18.1 Solution Summary	133
18.2 Results and Possible Applications	134
18.3 Comparison with Existing Solutions	135
18.4 Limitations	135
18.5 Future Development	136
19 Conclusion	137
Bibliography	139

Appendices

A GEX Hub Schematics	147
A.1 GEX Hub Revision 1	147
A.2 GEX Hub Revision 2	148
B GEX Zero Schematics	149
B.1 GEX Zero Revision 1	149
B.2 GEX Zero Revision 2	150
C Wireless Gateway Schematics	151
C.1 Wireless Gateway Revision 1	151

Figures

1.1 A collection of intelligent sensors and devices	3
2.1 A Discovery board with STM32F072	9
2.2 Form factor sketches	9
3.1 Raspberry Pi minicomputers	11
3.2 Bus Pirate v.4 (photo taken from [1])	12
3.3 Professional tools that GEX can replace	13
4.1 USB hierarchical structure	17
4.2 The logical structure of USB	18
4.3 USB descriptors of a GEX prototype obtained using “lsusb”	20
4.4 USB pull-ups	21
6.1 An example of the GEX virtual file system	31
7.1 UART frame format	35
7.2 SPI timing diagram	37
7.3 SPI master with multiple slaves	37
7.4 I ² C message diagram	38
7.5 1-Wire connection topology with four slave devices	39
7.6 GEX prototype driving a strip of 5 NeoPixels	41
8.1 Direct frequency measurement method	44
8.2 Reciprocal frequency measurement method	44
8.3 Frequency measurement methods comparison	45
8.4 A diagram of the SAR type ADC	46
8.5 A simple implementation of the waveform generator	47
8.6 A block diagram of a DDS-based waveform generator	48
8.7 The touch slider on a STM32F072 Discovery board	49
8.8 A simplified schematic of the touch sensing circuit	49
8.9 TSC operation oscilloscope screenshots	50
9.1 GEX conceptual overview	53

9.2 Physical user interface of a GEX module.....	54
9.3 Configuration file editor GUI.....	59
10.1 Block diagram showing the internal logic in the GEX firmware.....	61
10.2 An example allocation in the resource registry.....	63
10.3 Structure of the settings subsystem.....	63
11.1 General structure of the source code repository.....	67
12.1 TinyFrame API.....	71
12.2 The bulk read and write transactions.....	75
13.1 Pin packing.....	80
13.2 SPI transaction using the QUERY command.....	85
13.3 Principle of DMA-based UART reception.....	88
13.4 Principle of DMA-based ADC sampling.....	95
14.1 Test setup with a GEX prototype controlling two nRF24L01+ modules.....	103
14.2 Wireless connection block diagram.....	106
15.1 The GEX Hub module.....	110
15.2 GEX Zero compared to Raspberry Pi Zero.....	111
15.3 The GEX Zero module.....	112
15.4 GEX Zero back side.....	113
15.5 The wireless gateway (top and bottom side).....	114
16.1 GEX Zero with the Micro Dot pHAT add-on board.....	120
16.2 A demonstration of the MATLAB/Python integration.....	121
17.1 GEX Zero measuring a passive high-pass RC filter.....	127
17.2 RC filter frequency responses.....	128
17.3 Demo with a CO ₂ sensor.....	128
17.4 Capacitor charging waveform captured by the ADC unit.....	130
17.5 The “lightning trap” circuit.....	130
17.6 Captured lightning strikes.....	131

Tables

6.1 Areas of a FAT-formatted disk	29
6.2 Structure of a FAT16 directory entry	31
7.1 NeoPixel pulse timing	40
12.1 Frame types used by GEX	73
14.1 Comparison of the SX1276 and nRF24L01+ wireless transceivers	105
15.1 Comparison of the RPI Zero and GEX Zero GPIO headers	115

Acronyms

AC alternating current	IC integrated circuit
ACM Abstract Control Model	IDE integrated development environment
ADC analog/digital converter	IRQ interrupt request
API application programming interface	ISR interrupt service routine
BFSK binary frequency-shift keying	LCD liquid crystal display
BOT Bulk Only Transport	LED light emitting diode
CAN Controller Area Network	LFN Long File Name
CDC Communication Devices Class	LIN Local Interconnect Network
CDC/ACM Communication Devices Class / Abstract Control Model	MBR Master Boot Record
CPHA Clock Phase	M-Bus Meter Bus
CPOL Clock Polarity	MCU microcontroller unit
CRC cyclic redundancy check	MISO Master In, Slave Out
CSB Chip Select with Bar	MOSI Master Out, Slave In
CTS Clear To Send	MSC Mass Storage Class
DAC digital/analog converter	MSK minimum-shift keying
DALI Digital Addressable Lighting Interface	NCO numerically controlled oscillator
DC direct current	NDIR nondispersive infrared
DDS Direct Digital Synthesis	NFC Near-Field Communication
DE Driver Enable	NRZI Non Return to Zero Inverted
DFU Device Firmware Update	NSS Negated Slave Select
DMA Direct Memory Access	NVIC Nested Vectored Interrupt Controller
DTR Data Terminal Ready	OOK on-off keying
FAT File Allocation Table	OS operating system
FS file system	PC personal computer
FSK frequency-shift keying	PCB printed circuit board
GFSK Gaussian frequency-shift keying	PMBus Power Management Bus
GMSK Gaussian minimum-shift keying	PWM pulse width modulation
GND ground	RAM random-access memory
GPIO general purpose input/output	ROM read-only memory
GPS Global Positioning System	RTC Real-Time Clock
GSM Global System for Mobile communications	RTS Ready To Send
GUI graphical user interface	SAR successive approximation register
HART Highway Addressable Remote Transducer	SCCB Serial Camera Control Bus
I²C Inter-Integrated Circuit	SCK Serial Clock
I²S Inter-IC Sound	SCL Serial Clock Line
IAD Interface Association Descriptor	SCSI Small Computer System Interface
	SDA Serial Data Line
	SMBus System Management Bus
	SPI Serial Peripheral Interconnect
	SS Slave Select
	SSH Secure Shell

STEM science, technology, engineering
and mathematics

TCO temperature-compensated oscilla-
tor

TSC Touch Sensing Controller

TTL Transistor-Transistor Logic

TVS transiet-voltage suppressor

TWI Two-Wire Interface

UART Universal Asynchronous Re-
ceiver/Transmitter

USART Universal Synchronous/Asynchronous
Receiver/Transmitter

USB Universal Serial Bus

VCO voltage-controlled oscillator



Part I

Introduction

Chapter 1

Motivation

Prototyping, design evaluation, and the measurement of physical properties in experiments make a daily occurrence in the engineering praxis. Those tasks often involve the generation and sampling of electrical signals coming to and from sensors, actuators, and other circuitry.

Recently, a wide range of intelligent sensors became available thanks to the drive to miniaturization in the consumer electronics industry (Figure 1.1). Those devices often provide sufficient accuracy and precision while keeping the circuit complexity and cost low. In contrast to analog sensors, here the signal conditioning and processing circuits are built into the sensor itself, and we access it using a digital connection.

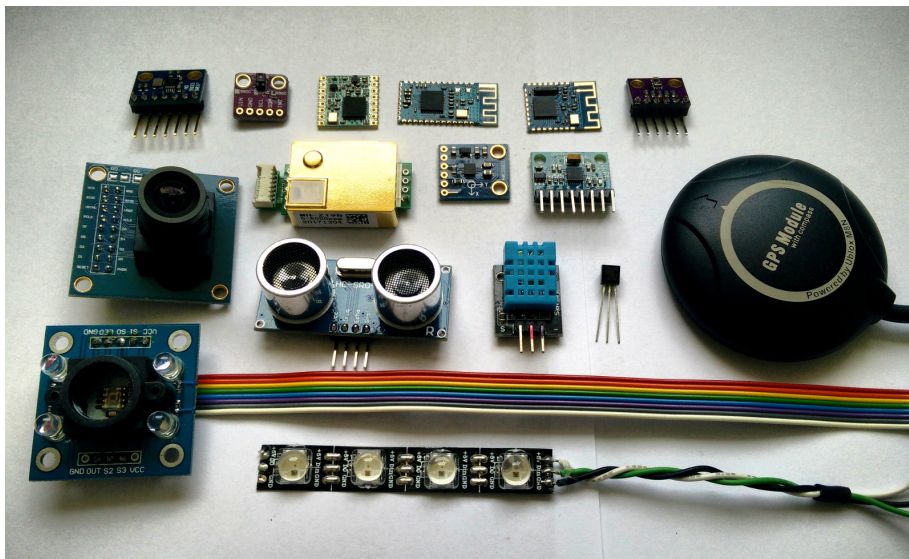

Figure 1.1: A collection of intelligent sensors and devices, most on breadboard adapters: (from the top left) a waveform generator, a gesture detector, a LoRa and two Bluetooth modules, an air quality and pressure sensor, a CO₂ sensor, a digital compass, an accelerometer, a GPS module, a camera, an ultrasonic range finder, a humidity sensor, a 1-Wire thermometer, a color detector, and an RGB LED strip

If we wish to conduct experiments with those integrated modules, or just familiarize ourselves with a device before using it in a project, we need an easy way to interact with them. It would also be convenient to have direct access to low-level hardware, be it analog signal sampling, generation, or even just the access to logic inputs and outputs. However, advances in computer technology, namely the advent of the **Universal Serial Bus (USB)**,

lead to the disappearance of low-level computer ports, such as the printer port (LPT), that would provide an easy way of doing so.

Today, when we want to perform measurements using a digital sensor, the usual route is to implement an embedded firmware for a microcontroller that connects to the **personal computer (PC)** through **USB**, or perhaps shows the results on a display. This approach has its advantages, but is time-consuming and requires specific knowledge unrelated to the measurements we wish to perform. It would be advantageous to have a way to access hardware without having to burden ourselves with the technicalities of this connection, even at the cost of lower performance compared to specialized devices or professional tools.

The design and implementation of such a universal instrument is the object of this work. For technical reasons, such as naming the source code repositories, we need a name for the project; it shall be, hereafter, called **GEX**, a name originating from “**GPIO Expander**”.

■ 1.1 Expected Outcome

It has been a long-time desire of the author to create a universal instrument connecting low-level hardware to a computer, and, with this project, it is finally being realized. Several related projects approaching this problem from different angles can be found on the internet; some of these will be presented in **Chapter 3**.

Our project is not meant to end with a tinkering tool that will be produced in a few prototypes and then forgotten. By creating an extensible, open-source platform, GEX can become the foundation for future projects which others can expand, re-use and adapt to their specific needs.

Building on the experience with earlier embedded projects, an STM32 microcontroller will be used. Those are Arm Cortex-M devices with a wide range of hardware peripherals that appear be a good fit for the project. Low-cost evaluation boards are widely available that could be used as a hardware platform instead of developing a custom **printed circuit board (PCB)**. STM32 microcontrollers are relatively cheap and already popular in the embedded hardware community; there is a real possibility of the project gathering a community around it and growing beyond what will be presented in this paper.

Chapter 2

Requirement Analysis

We'll now investigate some situations where GEX could be used, to establish its requirements and desired features.

2.1 Desired Features

2.1.1 Interfacing Intelligent Modules

When adding a new digital sensor or a module to a hardware project, we want to test it first, learn how to properly communicate with it, and confirm its performance. Based on this evaluation we decide whether the module matches our expectations and learn how to properly connect it, which is needed for a successful PCB layout.

In experimental setups, this may be the only thing we need. Data can readily be collected after just connecting the module to a PC, same as commanding motor controllers or other intelligent devices.

A couple of well known hardware buses have established themselves as the standard ways to interface digital sensors and modules: **Serial Peripheral Interconnect (SPI)**, **Inter-Integrated Circuit (I²C)** and **Universal Synchronous/Asynchronous Receiver/Transmitter (USART)** (UART in asynchronous mode) are some of the most common ones, often accompanied by a few extra **general purpose input/output (GPIO)** lines for features such as Reset, Chip Enable, or Interrupt. There are exceptions where silicon vendors have developed proprietary communication protocols that continue to be used either for historical reasons, or because of their specific advantages. An example is the Dallas Semiconductor 1-Wire bus used in digital thermometers.

Moving to industrial and automotive environments, we encounter various fieldbuses, Ethernet, **Controller Area Network (CAN)**, current loop, **Highway Addressable Remote Transducer (HART)**, **Local Interconnect Network (LIN)**, **Digital Addressable Lighting Interface (DALI)**, RS-485 (e.g., for Modbus), **Meter Bus (M-Bus)**, PLC-BUS, and others. Those typically use transceiver **integrated circuits (ICs)** and other circuitry, such as **transient-voltage suppressors (TVSs)**, signal filters, or galvanic isolation. They could be supported using add-on boards and additional firmware modules handling the protocol. For simplicity and to meet time constraints, the development of those boards and modules will be left for future expansions of the project.

■ 2.1.2 Analog Signal Acquisition

Sometimes it is necessary to use a traditional analog sensor, capture a transient waveform, or to just measure voltage. GEX is meant to focus on digital interfaces, however giving it this capability makes it much more versatile. Nearly all microcontrollers include an **analog/digital converter (ADC)** which we can use to measure input voltages and, paired with a timer, to records signals varying in time.

Certain tasks, such as capturing transient effects on a thermocouple when inserted into a flame (an example from developing fire-proof materials) demand level triggering similar to that of oscilloscopes. The converter continuously measures the input voltage and a timed capture starts only after a set threshold is exceeded. This can be accompanied by a pre-trigger feature where the timed capture is continuously running and the last sample is always compared with the threshold, recording a portion of the historic records together with the following samples.

■ 2.1.3 Analog Signal Output

An analog signal can not only be measured, but it is often necessary to also generate it. This could serve as an excitation signal for an experiment, for instance to measure the characteristic curves of a diode or a transistor. Conveniently, we can at the same time use GEX's analog input to record the output.

Generating an analog signal is possible using a **pulse width modulation (PWM)** or by a dedicated digital-analog converter included in many microcontrollers. Higher frequencies or resolution can be achieved with a dedicated external **IC**.

■ 2.1.4 Logic Level Input and Output

We have covered some more advanced features, but skipped the simplest feature: direct access to **GPIO** pins. Considering the latencies of **USB** and the **PC's operating system (OS)**, this cannot be used reliably for “bit banging”; however, we can still accomplish a lot with just changing logic levels—e.g., to control character **liquid crystal displays (LCDs)**, or emulate some interfaces that include a clock line, like **SPI**. As mentioned in **Section 2.1.1**, many digital sensors and modules use plain **GPIOs** in addition to the communication bus for out-of-band signaling or features like chip selection or reset.

■ 2.1.5 Pulse Generation and Measurement

Some sensors have a variable frequency or a **PWM** output. To capture those signals and convert them to a more useful digital value, we can use the external input functions of a timer/counter in the microcontroller. Those timers have many possible configurations and can also be used for pulse counting or waveform generation.

2.2 Connection to the Host Computer

2.2.1 Communication Interface

USB shall be the primary way of connecting the module to a host **PC**. Thanks to **USB**'s flexibility, it can present itself as any kind of device or even multiple devices at once.

The most straightforward method of interfacing the board is by passing binary messages in a fashion similar to **UART**. We'll need a duplex connection to enable command confirmations, query-type commands and asynchronous event reporting. This is possible either using a "Virtual COM port" driver, or through raw access to the corresponding **USB** endpoints. Using raw access avoids potential problems with the **OS**'s driver interfering or not recognizing the device correctly; on the other hand, having **GEX** appear as a serial port makes it easier to integrate into existing platforms that have good serial port support (such as National Instruments LabWindows CVI or MATLAB).

A connection using a hardware **UART** is also planned, as a fallback for boards without an **USB** connector or for platforms with no **USB** connectivity. A wireless connection to the host **PC** should also be possible and work transparently in a similar way to the **USB** or **UART** connection.

2.2.2 Configuration Files

The module must be easily reconfigurable. Given the settings are almost always going to be tied to the connected external hardware, it would be practical to have an option to store them permanently in the microcontroller's non-volatile memory.

We can load those settings into **GEX** using the serial interface, which also makes it possible to reconfigure it remotely when the wireless connection is used. With **USB**, we can additionally make the board appear as a mass storage device and expose the configuration as text files. This approach, inspired by Arm Mbed's mechanism for flashing firmware images to development kits, avoids the need to create a configuration **graphical user interface (GUI)**, instead using the built-in applications of the **PC OS** to view and edit files. Besides the configuration files, we can expose additional information, such as a **README** file with instructions, or a pin-out reference, as separate files on the virtual disk.

2.3 An Overview of Planned Features

Summarizing the preceding discussion, we obtain the following list of features to implement in the **GEX** firmware:

- **Hardware interfacing functions**
 - I/O pin direct access (read, write), pin change interrupt
 - Analog input: voltage measurement, sampled capture
 - Analog output: static level, waveform generation

- Frequency, duty cycle, pulse length measurement
- Single pulse and **PWM** generation
- **SPI**, **I²C**, **UART/USART**, 1-Wire
- **Communication with the host computer**
 - **USB** connection as virtual serial port or direct endpoint access
 - Connection using plain **UART**
 - Wireless attachment
- **Configuration**
 - Fully reconfigurable, temporarily or permanently
 - Settings stored in INI files
 - File access through the communication interface or using a virtual mass storage

2.4 Microcontroller Selection

As discussed in [Section 1.1](#), this project will be based on microcontrollers from the STM32 family. The STM32F072 model was selected for the initial hardware and firmware design due to its low cost, advanced peripherals, and the availability of development boards. The firmware can be ported to other **microcontroller units (MCUs)** later (e.g., to STM32L072, STM32F103 or STM32F303).

The STM32F072 is an Arm Cortex-M device with 128 KiB of flash memory, 16 KiB of **random-access memory (RAM)** and running at 48 MHz. It is equipped with a **USB Full Speed** peripheral block, a 12-bit **ADC** and **digital/analog converter (DAC)**, a number of general-purpose timers/counters, SPI, I²C, and USART peripherals, among others. It supports crystal-less **USB**, using the USB SOF packet for synchronization of the internal 48 MHz RC oscillator; naturally, a real crystal resonator will provide better timing accuracy.

To effectively utilize the time available for this work, only the STM32F072 firmware will be developed while making sure the planned expansion is as straightforward as possible.

2.5 Form Factor Considerations

While the GEX firmware can be used with existing evaluation boards from ST Microelectronics ([Figure 2.1](#)), we wish to design and realize a few custom hardware prototypes that will be smaller and more convenient to use.

Three possible form factors are drawn in [Figure 2.2](#). The use of a common connector layout and pin assignments, here Arduino and Raspberry Pi, makes it possible to reuse add-on boards from those platforms. When we copy the physical form factor of another product, in this example the Raspberry Pi Zero, we can further take advantage of existing enclosures designed for it.

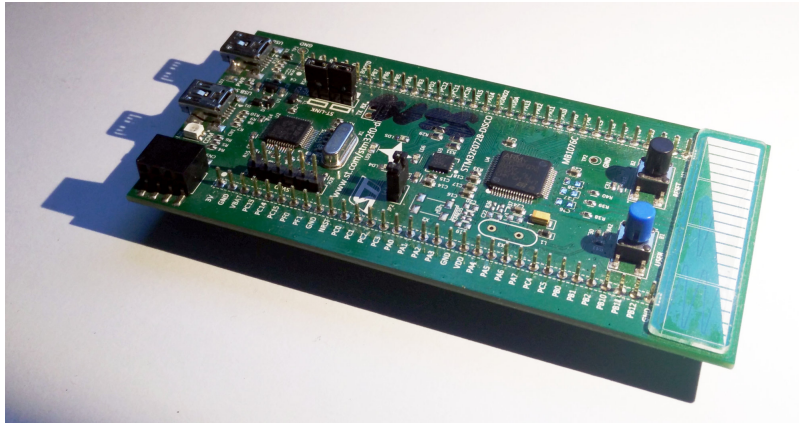

Figure 2.1: A Discovery development board with the STM32F072 microcontroller

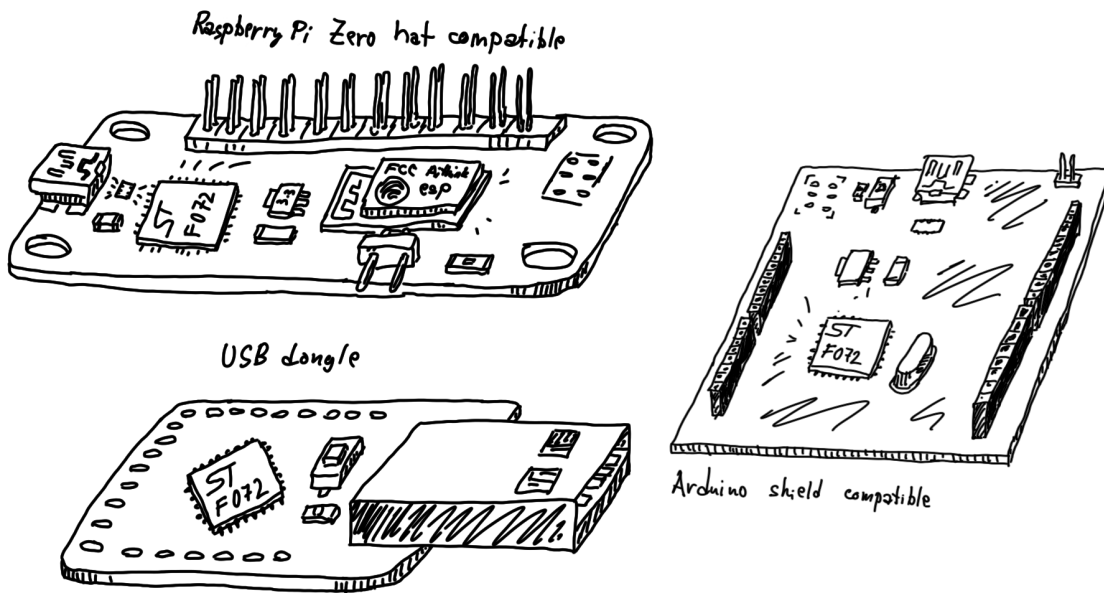

Figure 2.2: A sketch of three possible form factors for a GEX hardware realization

Chapter 3

Existing Solutions

The idea of making it easier to interact with low-level hardware from a **PC** is not new. Several solutions to this problem have been developed, each with its own advantages and drawbacks. Some examples will be presented in this chapter.

3.1 Raspberry Pi

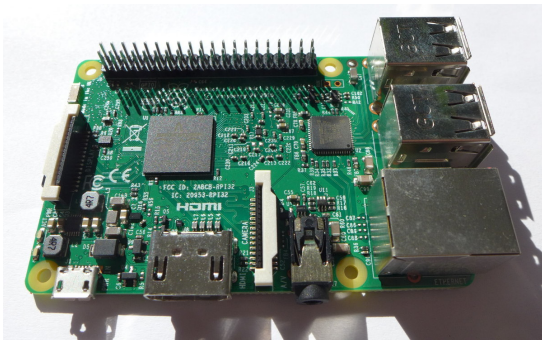

(a) : Raspberry Pi 3 Model B

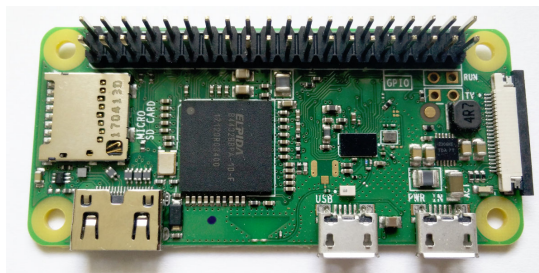

(b) : Raspberry Pi Zero W

Figure 3.1: Raspberry Pi minicomputers

The Raspberry Pi (Figure 3.1) is a low-cost minicomputer targeted at school environments and hobbyists. It is often used for home automation, as a simple web server, or built into projects that take advantage of its powerful processor, such as wildlife camera traps, or data acquisition devices with in-situ processing.

The board's **GPIO** header, a row of pins supporting features such as **SPI**, **I²C**, **UART**, or **PWM**, directly accessible by user applications running on the minicomputer, was one of the inspirations behind GEX.

The Raspberry Pi's functionality clearly overlaps with features we wish to support in GEX. Its processor is powerful enough for a regular **OS** with a graphical user interface, and after attaching a display and a keyboard, it can be used as a **PC**. However, when we have a more powerful computer available and only want to extend it with the **GPIO** header, having to use the Raspberry Pi seems inconvenient; this might be overcome with the use of screen sharing or **Secure Shell (SSH)**, but a low-complexity solution like GEX certainly has its appeal.

3.2 Bus Pirate

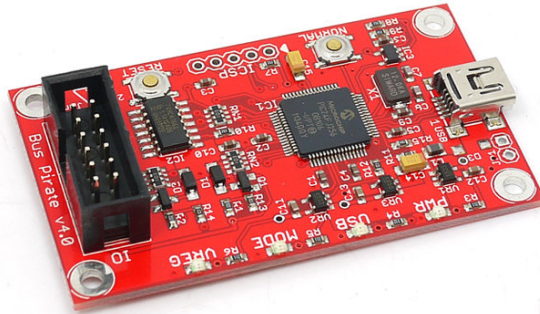

Figure 3.2: Bus Pirate v.4 (photo taken from [1])

Bus Pirate [2] is a USB-attached device providing access to hardware interfaces like **SPI**, **I²C**, **USART**, and 1-Wire, as well as features like frequency measurement and direct pin access. The board aims to make it easy for users to familiarize themselves with unknown chips and modules; it also provides a range of programming interfaces to program microcontrollers and memory chips. The board communicates with the **PC** using an FTDI USB-serial adapter.

Bus Pirate is open source and is, in its scope, similar to GEX. It can be scripted and controlled from the PC, connects to USB and provides a wide selection of hardware interfaces.

The board is based on a PIC16 microcontroller running at 32 MHz. Its **ADC** only has a resolution of 10 bits (1024 levels). There is no **DAC** available on the chip, which makes applications that require a varied output voltage more difficult to implement. Another limitation of the board is its low number of **GPIO** pins, which may be insufficient for certain applications; this, however, is not a hindrance to its main purpose as a bus analyzer and tinkering tool.

The Bus Pirate is available for purchase at around 30 USD (at the time of writing), a price comparable to some Raspberry Pi models.

3.3 Professional DAQ Modules

Various professional tools that would fulfill our needs exist on the market, but their high price makes them inaccessible for users with a limited budget, such as hobbyists or students who would like to keep such a device for personal use. An example is the National Instruments I²C/SPI Interface Device which also includes several **GPIO** lines, their USB DAQ module, or some of the Total Phase I²C/SPI gadgets (Figure 3.3).

The performance GEX can provide may not always match that of those professional tools, but in many cases it will be a sufficient substitute at a fraction of the cost.



(a) : NI I²C/SPI Interface Device

(b) : NI USB DAQ module



(c) : Total Phase SPI/I²C Host "Aardvark"

Figure 3.3: An example of professional tools that GEX could replace in less demanding scenarios (pictures taken from marketing materials: [3, 4, 5])



Part II

Theoretical Background

Chapter 4

Universal Serial Bus

This chapter presents an overview of the **Universal Serial Bus (USB)** Full Speed interface, with focus on the features used in the GEX firmware. **USB** is a versatile and powerful interface which replaces several older technologies; for this reason its specification is very complex and going into all details is hardly possible. We will cover the basic principles and terminology of **USB** and focus on the parts relevant for the GEX project. More information about the bus can be found in the official specification [6], related documents published by the USB Implementers Forum, and other on-line resources [7, 8].

4.1 Basic Principles and Terminology

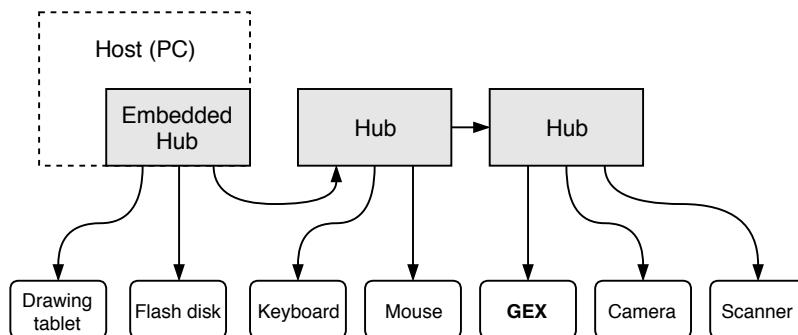

Figure 4.1: The hierarchical structure of the USB bus

USB is a hierarchical bus (Figure 4.1) with a single master (*host*) and multiple slave devices. A **USB** device that provides functionality to the host is called a *function* [9].

4.1.1 Pipes and Endpoints

Communication between the host and a function is organized into virtual channels called *pipes* connecting to the device's *endpoints*, identified by endpoint numbers. Pipes and endpoints are a high level abstraction of the connection between the host and a device (Figure 4.2).

Endpoints can be either unidirectional or bidirectional; the direction from the host to a function is called **OUT**, the other direction (function to host) is called **IN**. A bidirectional endpoint is technically composed of **IN** and **OUT** endpoints with the same number. All

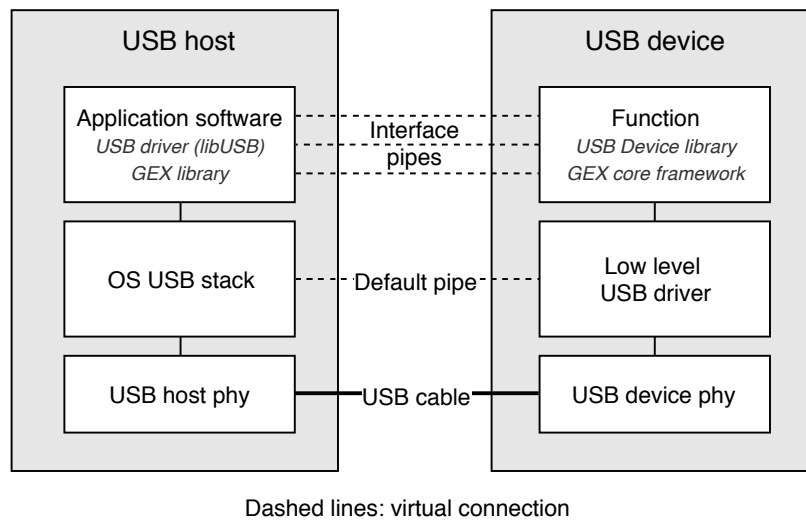

Figure 4.2: The logical structure of USB

transactions (both IN and OUT) are initiated by the host; functions have to wait for their turn. Endpoint 0 is bidirectional, always enabled, and serves as a *control endpoint*. The host uses the control endpoint to read information about the device and configure it as needed.

■ 4.1.2 Transfer Types

There are four types of data transfers defined in **USB**: control, bulk, isochronous, and interrupt. Each endpoint is configured for a fixed transfer type:

- *Control* – initial configuration after device plug-in; also used for other application-specific control messages that can affect other pipes.
- *Bulk* – used for burst transfers of large messages
- *Isochronous* – streaming with guaranteed low latency; designed for audio or video streams where some data loss is preferred over stuttering
- *Interrupt* – low latency short messages, used for human interface devices like mice and keyboards

■ 4.1.3 Interfaces and Classes

The function's endpoints are grouped into *interfaces*. An interface describes a logical connection of endpoints, such as the reception and transmission endpoints that belong together. An interface is assigned a *class* defining how it should be used.

Standard classes are defined by the USB specification [10] to provide a uniform way of interfacing devices of the same type, such as human-interface devices (mice, keyboards,

gamepads) or mass storage devices. The use of standard classes makes it possible to re-use the same driver software for devices from different manufacturers.

The class used for the GEX’s “virtual COM port” function was originally meant for telephone modems, a common way of connecting to the Internet at the time the first versions of USB were developed. A device using this class will show as `/dev/ttyACMO` on Linux and as a COM port on Windows, provided the system supports it natively or the right driver is installed.

■ 4.1.4 Descriptors

USB devices are introspectable, that is, the host can learn about a newly connected device automatically by probing it, without any user interaction. This is accomplished using a *descriptor table*, a binary structure stored in the function and read by the host through the control endpoint (default pipe) after the device is attached.

Each descriptor starts with a declaration of its length (in bytes), followed by its type, allowing the host to skip unknown descriptors without having to discard the rest of the table. The descriptors are logically nested and form a tree-like structure, but they are stored sequentially in the descriptor table and the lengths do not include sub-descriptors.

The topmost descriptor holds information about the entire function, including the vendor and product IDs which uniquely identifies the device model. It is followed by a Configuration descriptor, grouping a set of interfaces. More than one configuration may be present and available for the host to choose from; however, this is rarely used or needed. Each configuration descriptor is followed by one or more interface descriptors, each with its class-specific sub-descriptors and/or endpoint descriptors.

The descriptor table used by GEX is captured in [Figure 4.3](#) for illustration. The vendor and product IDs were obtained from the `pid.codes` repository [11] providing free product codes to open source projects. The official way of obtaining the unique code involves high recurring fees (\$4000 per annum) to the USB Implementers Forum, Inc. and is therefore not affordable for non-commercial use; alternatively, a product code may be obtained from some **MCU** vendors if their product is used in the device.

4. Universal Serial Bus

```

Device Descriptor:
  bLength           18
  bDescriptorType   1
  bcdUSB            2.00
  bDeviceClass      239 Miscellaneous Device
  bDeviceSubClass   2
  bDeviceProtocol   1 Interface Association
  bMaxPacketSize0   64
  idVendor          0x1209 InterBiometrics
  idProduct         0x4c60
  bcdDevice         0.01
  iManufacturer     1 MightyPork
  iProduct          2 GEX
  iSerial           3 0029002F-42365711-32353530
  bNumConfigurations 1
Configuration Descriptor:
  bLength           9
  bDescriptorType   2
  wTotalLength      98
  bNumInterfaces    3
  bConfigurationValue 1
  iConfiguration    0
  bmAttributes      0x80
    (Bus Powered)
  MaxPower          500mA
Interface Descriptor:
  bLength           9
  bDescriptorType   4
  bInterfaceNumber  0
  bAlternateSetting 0
  bNumEndpoints    2
  bInterfaceClass   8 Mass Storage
  bInterfaceSubClass 6 SCSI
  bInterfaceProtocol 80 Bulk-Only
  iInterface        4 Settings VFS
Endpoint Descriptor:
  bLength           7
  bDescriptorType   5
  bEndpointAddress 0x81 EP 1 IN
  bmAttributes      2
    Transfer Type   Bulk
    Synch Type      None
    Usage Type      Data
  wMaxPacketSize   0x0040 1x 64 bytes
  bInterval         0
Endpoint Descriptor:
  bLength           7
  bDescriptorType   5
  bEndpointAddress 0x01 EP 1 OUT
  bmAttributes      2
    Transfer Type   Bulk
    Synch Type      None
    Usage Type      Data
  wMaxPacketSize   0x0040 1x 64 bytes
  bInterval         0
Interface Association:
  bLength           8
  bDescriptorType   11
  bFirstInterface   1
  bInterfaceCount   2
  bFunctionClass     2 Communications
  bFunctionSubClass  2 Abstract (modem)
  bFunctionProtocol  1 AT-commands (v.25ter)
  iFunction         5 Virtual Comport ACM

Interface Descriptor:
  bLength           9
  bDescriptorType   4
  bInterfaceNumber  1
  bAlternateSetting 0
  bNumEndpoints    1
  bInterfaceClass   2 Communications
  bInterfaceSubClass 2 Abstract (modem)
  bInterfaceProtocol 1 AT-commands (v.25ter)
  iInterface        5 Virtual Comport ACM
CDC Header:
  bcdCDC            1.10
CDC Call Management:
  bmCapabilities    0x00
  bDataInterface    2
CDC ACM:
  bmCapabilities    0x06
    sends break
    line coding and serial state
CDC Union:
  bMasterInterface  1
  bSlaveInterface   2
Endpoint Descriptor:
  bLength           7
  bDescriptorType   5
  bEndpointAddress 0x83 EP 3 IN
  bmAttributes      3
    Transfer Type   Interrupt
    Synch Type      None
    Usage Type      Data
  wMaxPacketSize   0x0008 1x 8 bytes
  bInterval         255
Interface Descriptor:
  bLength           9
  bDescriptorType   4
  bInterfaceNumber  2
  bAlternateSetting 0
  bNumEndpoints    2
  bInterfaceClass   10 CDC Data
  bInterfaceSubClass 0
  bInterfaceProtocol 0
  iInterface        6 Virtual Comport CDC
Endpoint Descriptor:
  bLength           7
  bDescriptorType   5
  bEndpointAddress 0x02 EP 2 OUT
  bmAttributes      2
    Transfer Type   Bulk
    Synch Type      None
    Usage Type      Data
  wMaxPacketSize   0x0040 1x 64 bytes
  bInterval         0
Endpoint Descriptor:
  bLength           7
  bDescriptorType   5
  bEndpointAddress 0x82 EP 2 IN
  bmAttributes      2
    Transfer Type   Bulk
    Synch Type      None
    Usage Type      Data
  wMaxPacketSize   0x0040 1x 64 bytes
  bInterval         0

```

Figure 4.3: USB descriptors of a GEX prototype obtained using “lsusb”

4.2 USB Physical Layer

USB uses differential signaling with **Non Return to Zero Inverted (NRZI)** encoding and bit stuffing (the insertion of dummy bits to prevent long intervals in the same **DC** level). The encoding, together with frame formatting, checksum verification, retransmission, and other low-level aspects of the **USB** connection are entirely handled by the **USB** physical interface block in the microcontroller's silicon. Normally we do not need to worry about those details; nonetheless, a curious reader may find more information in chapters 7 and 8 of [6]. The electrical characteristics of the physical connection deserve more attention, as they need to be understood correctly for a successful schematic and **PCB** design.

The **USB** cable contains 4 conductors: V_{BUS} (+5 V), D+, D-, and **ground (GND)**. The data lines, D+ and D-, are also commonly labeled DP and DM. This differential pair should be routed in parallel on the **PCB** and kept at the same length.

USB versions that share the same connector are backward compatible. The desired bus speed is requested by the device using a 1.5 k Ω pull-up resistor to 3.3 V on one of the data lines: D+ pulled high for Full Speed (shown in **Figure 4.4**), D- pulled high for Low Speed. The polarity of the differential signals is also inverted depending on the used speed, as the idle level changes. Some microcontrollers integrate the correct pull-up resistor inside the **USB** peripheral block (including out STM32F072), removing the need for an external resistor.

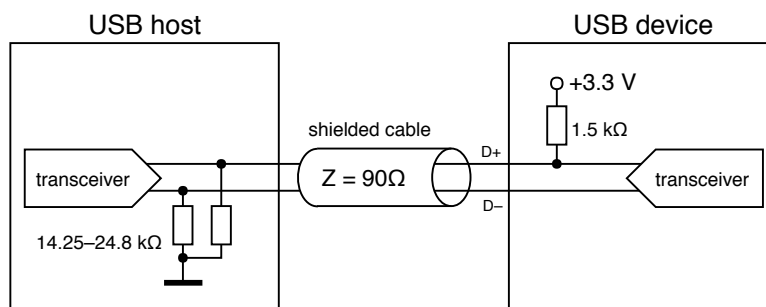

Figure 4.4: Pull-up and pull-down resistors near the host and a Full Speed function, as prescribed by the USB specification rev. 2.0

When a function needs to be re-enumerated by the host, which causes a reload of the descriptor table and the re-attachment of software drivers, it can momentarily remove the pull-up resistor, which the host will interpret as if the device was disconnected. With an internal pull-up, this can be done by flipping a bit in a control register. An external resistor may be connected through a transistor controlled by a **GPIO** pin. As discussed in [12], a **GPIO** pin might be used to drive the pull-up directly, though this has not been verified by the author.

The V_{BUS} line supplies power to *bus-powered* devices. *Self-powered* devices can leave this pin unconnected and instead use an external power supply. The maximal current drawn from the V_{BUS} line is configured using a descriptor and should not be exceeded, but experiments suggest this is often not enforced.

which defines control commands. Three endpoints are used: bulk IN, bulk OUT, and interrupt OUT.

The interrupt endpoint is used for control commands, such as toggling the auxiliary lines of RS-232 or setting the baud rate. Since GEX does not translate the data communication to any physical UART, those commands are not applicable and can be silently ignored.

An interesting property of the **CDC** class is that the bulk endpoints transport raw data without any wrapping frames. By changing the interface's class in the descriptor table to 255 (*Vendor Specific Class*), we can retain the messaging functionality of the designated endpoints, while accessing the endpoints device directly using, e.g., libUSB, without any interference from the **OS**. This approach is also used to hide the **MSC** interface when it is not needed.

4.3.3 Interface Association: Composite Class

The original **USB** specification expected that each function will have only one interface enabled at a time. After it became apparent that there is a need to have multiple unrelated interfaces working in parallel, the **Interface Association Descriptor (IAD)** [18] was introduced as a workaround.

The **IAD** is an entry in the descriptor table that defines which interfaces belong together and should be handled by the same software driver. To use the **IAD**, the function's class must be set to 0xEF, subclass 0x02, and protocol 0x01 in the top level descriptor, so that the **OS** knows to look for this descriptor before binding drivers to any interfaces.

In GEX, the **IAD** is used to tie together the **CDC** and **ACM** interfaces while leaving out the **MSC** interface which should be handled by a different driver. To make this work, a new *composite class* was created as a wrapper for the library-provided **MSC** and **CDC/ACM** implementation.

Chapter 5

FreeRTOS

FreeRTOS is a free, open-source real-time operating system kernel targeted at embedded systems; it has been ported to many different microcontroller architectures [19] and it is the de-facto industry standard. The system is compact and designed to be easy to understand; it is written in C, with the exception of some architecture-specific routines which use assembly. A complete overview of its **application programming interface (API)** is available in the FreeRTOS reference manual [20] and its guide book [21].

FreeRTOS provides a task scheduler, forming the central part of the system, and implements queues, semaphores, and mutexes for message passing and the synchronization of concurrent tasks. Those features are summarily called *synchronization objects*, or simply *objects*.

The system is used in GEX for its synchronization objects that allow us to safely pass messages between interrupts and working threads, without deadlocks or race conditions; the particular usage of FreeRTOS features will be explained in **Section 10.7**. The built-in stack overflow protection helps us optimize task memory allocation¹, and the heap allocator provided by FreeRTOS enables thread-safe dynamic allocation with a shared heap.

5.1 Basic FreeRTOS Concepts and Functions

5.1.1 Tasks

Threads in FreeRTOS are called *tasks*. Each task is assigned a memory area to use as its stack space, and a holding structure with its name, saved *context*, and other metadata used by the kernel. A task context includes the program counter, stack pointer and other register values. Task switching is done by saving and restoring this context by manipulating the values on the stack before leaving an **interrupt service routine (ISR)**. The FreeRTOS website provides an example with the AVR port [22] demonstrating how its internal functionality is implemented, including the context switch.

At start-up the firmware initializes the kernel, registers tasks to run, and starts the scheduler. From this point onward the scheduler is in control and runs the tasks using a round robin scheme, always giving a task one tick of run time (usually 1 ms) before

¹The stack monitor reports how much stack space was really used, so we can expand or shrink it as needed to make the application work reliably, without wasting memory that would never be used.

interrupting it. Which task should run is determined primarily by their priority numbers, but there are other factors, as will be shown in [Section 5.1.1](#).

■ Task Run States

Tasks can be in one of four states: Suspended, Ready, Blocked, and Running. The Suspended state does not normally occur in a task's life cycle, it is entered and left using API calls from the application. A task is in the Ready state when it can run, but is currently paused because a higher priority task is running. It enters the Running state when the scheduler switches to it. A Running task can wait for a synchronization object (e.g., a mutex) to be available; at this point it enters a Blocked state and the scheduler runs the next Ready task. When no tasks can run, the Idle Task takes control; it can either enter a sleep state to save power, or wait in a loop until another task is available. The Idle task is always either Ready or Running and has the lowest priority of all tasks.

■ Task Switching and Interrupts

Task switching occurs periodically in a timer interrupt, usually every 1 ms; in Arm Cortex-M chips this is typically the SysTick interrupt, a timer designed for this purpose that is included in the core itself and thus available on all derived platforms.

After one tick of run time, the Running task is paused and becomes Ready, or continues to run if no higher-priority task is available. If a higher-priority task waits for an object and this is made available in an **ISR**, the running lower-priority task is paused and the waiting task resumes immediately. FreeRTOS defines interrupt-friendly variants of some of the **API** functions intended for this purpose; however, only a subset of the **API** is available in an **ISR**, for example, it is not possible to use the delay function or wait for an object with a timeout, as the SysTick interrupt, incrementing the tick counter, has the lowest priority and could not run. This is by design, intended to prevent unexpected context switching in application interrupts.

FreeRTOS uses a *priority inheritance* mechanism to prevent situations where a high-priority task waits for an object held by a lower-priority task (called *priority inversion*). The blocking task's priority is temporarily raised to the level of the blocked high-priority task so it can finish earlier and release the held object. Its priority is then degraded back to the original value. When the lower-priority task itself is blocked, the same process can be repeated.

■ 5.1.2 Synchronization Objects

FreeRTOS provides binary and counting semaphores, mutexes, and queues, which will now be briefly explained; a more in-depth description can be found in the guide book [21].

- **Binary semaphores** are used for task notifications, e.g., when a task waits for a semaphore to be set by an **ISR**. This makes the task Ready and if it has a higher priority than the task previously running, it is immediately resumed to process the event.

- **Counting semaphores** represent available resources in a resource pool, a set of software or hardware resources used by tasks. The pool is accompanied by a counting semaphore on which tasks wait for a resource to become available, and then subtract the semaphore value. After a resource is no longer needed by the task, the semaphore is incremented again and another task can use it.
- **Mutexes** (locks) are similar to semaphores, but they must be taken and released in the same task. We use them to guard an exclusive access to a resource, typically a hardware peripheral or a shared memory area. When a mutex is taken, any other tasks trying to take it too enter become Blocked. A Blocked task waiting for a mutex is resumed once this becomes available, at which point the task becomes its owner and is resumed.
- **Queues** are used for passing messages between tasks, or from interrupts to tasks. Both sending and receiving of queue messages can block the task until the operation becomes possible. A queue handling task is often simply a loop which tries to read from the queue with an infinite timeout and processes the received data once the reading succeeds.

It must be noted that synchronization objects like mutexes and semaphores can help combat concurrent access only when used consistently and correctly. A locked mutex cannot guard against a rogue task accessing the protected resource without checking.

5.2 Stack Overflow Protection

Each task in FreeRTOS is assigned a block of **RAM** to use as its stack when it runs. This is where the stack pointer is restored to in the context switch. The stack pointer could move outside the designated area if the allocated space is insufficient; without countermeasures, this would mean that we are overwriting bytes in some unrelated memory structure, perhaps another task's stack memory.

A stack overflow protection can be enabled by a flag in the FreeRTOS configuration file. This function works in two ways: the more obvious is a simple check that the stack pointer remains in the designated area; however, as the check may be performed only in the scheduler interrupt, it is possible that the stack pointer exceeds the bounds only temporarily and returns back before the check can run. A more advanced solution, used by FreeRTOS, fills the stack memory with a known filler value before starting the task; the last few bytes are then tested to match this value. Not only can we detect a stack overflow more reliably, this feature also makes it possible to estimate the peak stack usage by counting the remaining filler bytes. We cannot distinguish between the original values and the same data stored on the stack by the program, but the possibility of this happening is sufficiently low and this method proves remarkably successful at detecting misconfigured stack sizes.

Chapter 6

The FAT16 File System and Its Emulation

A **file system (FS)** is used by GEX to provide the user comfortable access to the configuration files. By emulating a mass storage **USB** device, the module appears as a thumb drive on the host **PC**, and the user can edit its configuration using their preferred text editor. The FAT16 file system was selected for its simplicity and good cross-platform support [23].

Three variants of the **File Allocation Table (FAT)** file system exist: FAT12, FAT16, and FAT32. FAT12 was used on floppy disks and is similar to FAT16, except for additional size constraints and a **FAT** entry packing scheme. FAT16 and FAT32 are FAT12's later developments from the time when hard disks became more common and the old addressing scheme could not support their larger capacity.

This chapter will explain the structure of FAT16 and the challenges faced when trying to emulate it without a physical storage medium. A more detailed overview of the file system can be found in literature [24, 25, 26, 27, 28] consulted during the GEX firmware development, with the Microsoft white paper [28] giving the most complete description.

6.1 The General Structure of the FAT File System

The storage medium is organized into *sectors* (or *blocks*), usually 512 bytes long; that is the smallest addressing unit used by the file system. The disk starts with a *boot sector*, also called the **Master Boot Record (MBR)**, followed by optional reserved sectors, one or two copies of the file allocation table, and the root directory. All disk areas are aligned to a sector boundary:

Table 6.1: Areas of a FAT-formatted disk

Disk area	Size / Notes
Boot sector	1 sector
Reserved sectors	optional
FAT 1	1 or more sectors, depends on disk size
FAT 2	optional, a back-up copy of FAT 1
Root directory	1 or more sectors
Data area	Organized in <i>clusters</i>

6.1.1 Boot Sector

This is a 1-sector structure which holds the **OS** bootstrap code for bootable disks. The first 3 bytes are a jump instruction to the actual bootstrap code located later in the sector. What matters to us when implementing the file system is that the boot sector also contains data fields describing how the disk is organized, what file system is used, who formatted it, etc. The size of the **FAT** and the root directory is defined here. The exact structure of the boot sector can be found in either of [24, 25, 26, 27, 28] or in the attached GEX source code.

6.1.2 File Allocation Table

The data area of the disk is organized in clusters, logical allocation units composed of groups of sectors. The use of a larger allocation unit allows the system to use shorter addresses and thus support a larger disk capacity.

The **FAT** acts as a look-up table combined with linked lists. In FAT16, it is organized in 16-bit fields, each corresponding to one cluster. The first two entries in the allocation table are reserved and hold special values set by the disk formatter and the host **OS**: a “media descriptor” 0xFFF8 and a “clean/dirty flag” 0xFFFF/0x3FFF.

Files can span multiple clusters; each **FAT** entry either holds the address of the following file cluster, or a special value:

- 0x0000 – free cluster
- 0xFFFF – last cluster of the file (still including file data)
- 0xFFF7 – bad cluster

The bad cluster mark, 0xFFF7, is used for clusters which are known to corrupt data due to a flaw in the storage medium.

6.1.3 Root Directory

A directory is a record on the disk that can span several clusters and holds information about the files and sub-directories contained in it. The root directory has the same structure as any other directory; the difference lies in the fact that it is allocated with a fixed position and size when the disk is formatted, whereas other directories are stored in the same way as ordinary files and their capacity can be increased by simply expanding to another cluster.

Directories are organized in 32-byte entries representing individual files. [Table 6.2](#) shows the structure of one such entry. The name and extension fields form the well-known “8.3” file name format known from MS DOS¹. Longer file names are encoded using the **Long File Name (LFN)** scheme [29] as special hidden entries stored in the directory table alongside the regular “8.3” ones kept for backward compatibility.

The first byte of the file name has special meaning:

- 0x00 – indicates that there are no more files when searching the directory

¹“8.3” refers to the byte size of the name and extension fields in the directory entry.

Table 6.2: Structure of a FAT16 directory entry

Offset	Size (bytes)	Description
0	8	File name (padded with spaces)
8	3	File extension
11	1	File attributes
12	10	Reserved
22	2	Creation time
24	2	Creation date
26	2	Address of the first cluster
28	4	File size (bytes)

- 0xE5 – marks a free slot; this is used when a file is deleted
- 0x05 – indicates that the first byte should actually be 0xE5, a code used in some character sets at the time, and the slot is *not* free².
- Any other values, except 0x20 (space) and characters forbidden in a DOS file name, starts a valid file entry. Generally, only space, A–Z, 0–9, -, and _ should be used in file names for maximum compatibility.

The attributes field contains flags such as *directory*, *volume label*, *read-only* and *hidden*. Volume label is a special entry in the root directory defining the disk’s label shown by the host OS. A file with the directory bit set is actually a pointer to a subdirectory, meaning that when we open the linked cluster, we will find another directory table.

Figure 6.1 shows a possible organization of the GEX file system with two INI files, one spanning two clusters, the other being entirely inside one. The clusters need not be used completely; the exact sizes are stored in the files’ directory entries.

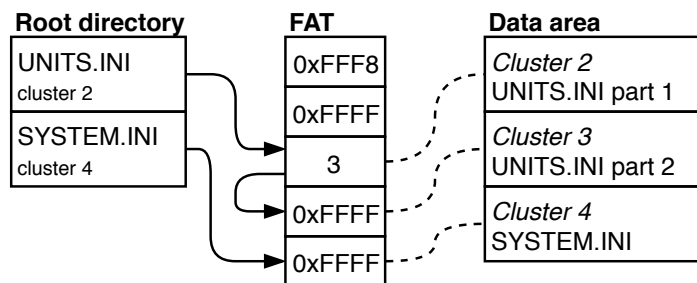
**Figure 6.1:** An example of the GEX virtual file system

²The special meaning of 0xE5 appears to be a correction of a less than ideal design choice earlier in the development of the file system

are modified. After each such change, an algorithm is run which measures the file sizes, allocates their clusters, and preserves this information for later use. When the host tries to read from the data area of the disk, we simply test if the requested sectors are occupied by any file, and if so, serve the corresponding part of it using the read window function. The **FAT** can be dynamically generated from this information as well.

■ 6.2.3 Write Access

Write access to the disk is more challenging to emulate than reading, as the host OS tends to be somewhat unpredictable. In GEX's case we are interested only in the action of overwriting an already existing file, but it is interesting to analyze other actions the host may perform as well.

It must be noted that due to the nonexistence of a physical storage medium, it is not possible to read back a file the host has previously written, unless we store or re-generate its content when such a read attempt occurs. The **OS** may show the written file on the disk, but when the user tried to open it, the action either fails, or shows a cached copy. The emulator works around this problem by temporarily reporting that the storage medium has been removed after a file is written, forcing the host to drop any cached data and reload the disk.

■ File Deletion

A file is deleted by:

1. Marking all **FAT** sectors used by the file as free
2. Replacing the first character of its name in the directory table by 0xE5 to indicate the slot is free

From the perspective of emulation, we can ignore the **FAT** access and only detect writes to the directory sectors. This is slightly more complicated when one considers that all disk access is performed in sectors: the emulator must compare the written data with the original bytes to detect what change has been performed. Alternatively, we could parse the entire written sector as a directory table and compare it with our knowledge of its original contents.

■ 6.2.4 File Name Change

A file is renamed by modifying its directory entry. In the simple case of a short, 8.3 file name, this is an in-place modification of the file entry. Long file names, using the **LFN** extension, are a complication, as the number of non-file entries holding the long file name might change, and subsequently the following entries in the table may shift or be re-arranged.

6.2.5 File Creation

A new file is created in three steps:

1. Finding free clusters and chaining them by writing the following cluster addresses (or 0xFFFF for the last cluster) into the **FAT**
2. Finding and overwriting a free entry in the directory table
3. Writing the file content

We can expect that the host first finds available sectors and a free directory entry before performing any write operations, to prevent potential disk corruption.

To properly handle a newly created file by the emulator, we could, in theory, find its name from the directory table, which has been updated, and then collect the data written to the corresponding clusters. In practice, confirmed by experiments with a real Linux host, the two latter steps may happen in any order, and often the content is written before the directory table is updated.

The uncertain order of the written areas poses a problem when the file name has any significance, as we cannot store the received file data while waiting for the directory table to be updated. The Arm DAPLink firmware solves this by analyzing the content of the first written sector of the file, which may contain the binary **Nested Vectored Interrupt Controller (NVIC)** table, or a character pattern typical for Intel hex files, allowing it to recognize a binary image the user wants to flash to the target **MCU**.

6.2.6 File Content Change

A change to file's content is performed in a similar way to the creation of a new file, except instead of creating a new entry in the directory table, an existing one is updated with the new file size. The name of the file may be unknown until the content is written, but we could detect the file name by comparing the start sector with those of all files known to the virtual file system.

In the case of GEX, the detection of a file name is not important; we expect only INI files to be written, and the particular file may be detected by its first section marker, such as **[UNITS]** or **[SYSTEM]**. Should a non-INI file be written by accident, the INI parser will likely detect a syntax error and discard it.

It should be noted that a file could be updated only partially, skipping the clusters which remain unchanged, and there is also no guarantee regarding the order in which the file's sectors are written. A non-linear or partial file update is hard to process for the emulator, but it can be reliably detected and discarded. Fortunately, this host behavior has not been conclusively observed in practice, but a file update rarely fails for unknown reasons; this could be a possible cause.

Chapter 7

Supported Hardware Buses

Hardware buses implemented in GEX are presented in this chapter. The description of each bus is accompanied by several examples of devices that can be interfaced with it. The reader is advised to consult the official specifications and particular devices' datasheets for additional details.

7.1 UART and USART

The **Universal Synchronous/Asynchronous Receiver/Transmitter (USART)** has a long history and is still in widespread use today. It is the protocol used in RS-232, which was once a common way of connecting modems, printers, mice and other devices to personal computers. RS-232 can be considered the ancestor of **USB** in its widespread availability and use. **UART** framing is also used in the industrial bus RS-485 and the automotive interconnect bus **LIN**.

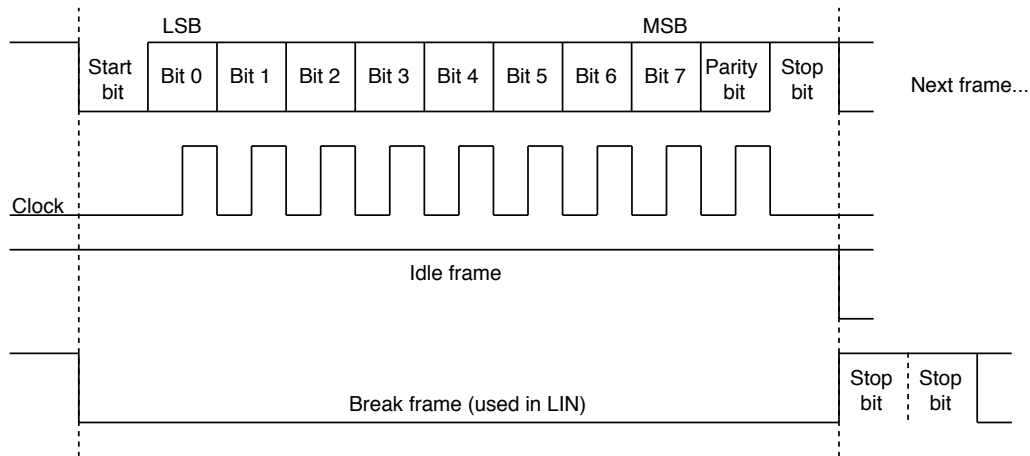

Figure 7.1: USART frame format in the 8-bit configuration with parity

UART and **USART** are two variants of the same interface. **USART** includes a separate clock signal, while the **UART** timing relies on a well-known clock speed and the bit clock is synchronized by start bits. **USART** was historically used in modems to achieve higher bandwidth, but is now mostly obsolete.

USART, as implemented by microcontrollers such as the STM32 family, is a two-wire full duplex interface that uses 3.3 V or 5 V logic levels. The data lines are in the high logical

level when idle. A **USART** frame, shown in **Figure 7.1**, starts by a start-bit (low level for the period of one bit) followed by n data bits (typically eight), an optional parity bit, and a period of high level called a stop bit (or stop bits), dividing consecutive frames.

RS-232 uses the **UART** framing, but its levels are different: logical 1 is represented by negative voltages -3 to -25 V and logical 0 uses the same range, but positive. To convert between RS-232 levels and **Transistor-Transistor Logic (TTL)** (5 V) levels, a level-shifting circuit such as the **MAX232** can be used. In RS-232, the two data lines (Rx and Tx) are accompanied by **Ready To Send (RTS)**, **Clear To Send (CTS)**, and **Data Terminal Ready (DTR)**, which facilitate handshaking and hardware flow control. In practice, those additional signals are often unused or their function differs from their historical meaning; for instance, Arduino boards (using a USB-serial converter) use the **DTR** line as a reset signal to automatically enter their bootloader for firmware flashing [31].

7.1.1 Examples of Devices Using UART

- **MH-Z19B** – nondispersive infrared (NDIR) CO_2 concentration sensor
- **NEO-M8** – uBlox **Global Positioning System (GPS)** module
- **ESP8266** with AT firmware – a WiFi module
- **MFRC522** – **Near-Field Communication (NFC)** MIFARE reader/writer IC (also supports other interfaces)

7.2 SPI

Serial Peripheral Interconnect (SPI) is a point-to-point or multi-drop master-slave interface based on shift registers. The **SPI** connection with multiple slave devices is depicted in **Figure 7.3**. It uses at least 4 wires: **Serial Clock (SCK)**, **Master Out, Slave In (MOSI)**, **Master In, Slave Out (MISO)** and **Slave Select (SS)**. **SS** is often marked **Chip Select with Bar (CSB)** or **Negated Slave Select (NSS)** to indicate that its active state is 0. Slave devices are addressed using their **SS** input while the data connections are shared. A slave that is not addressed releases the **MISO** line to a high impedance state so it does not interfere in ongoing communication.

Transmission and reception on the **SPI** bus happen simultaneously. A bus master asserts the **SS** pin of a slave it wishes to address and then sends data on the **MOSI** line while receiving a response on **MISO**. The slave normally responds with 0x00 or a status register as the first byte of the response, before it can process the received command. A timing diagram is shown in **Figure 7.2**, including two configurable parameters: **Clock Polarity (CPOL)** and **Clock Phase (CPHA)**.

SPI devices often provide a number of control, configuration and status registers that can be read and written by the bus master. The first byte of a command usually contains one bit that determines if it is a read or write access, and an address field selecting the target register. The slave then either stores the following **MOSI** byte(s) into the register, or sends its content back on **MISO** (or both simultaneously).

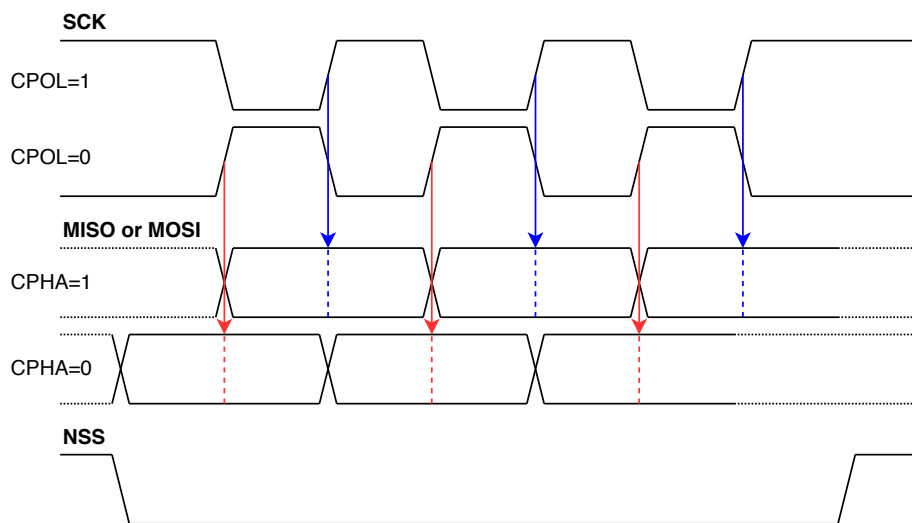

Figure 7.2: SPI timing diagram explaining the CPOL and CPHA settings (shown on 3 data bits; a real message will use at least 8 bits)

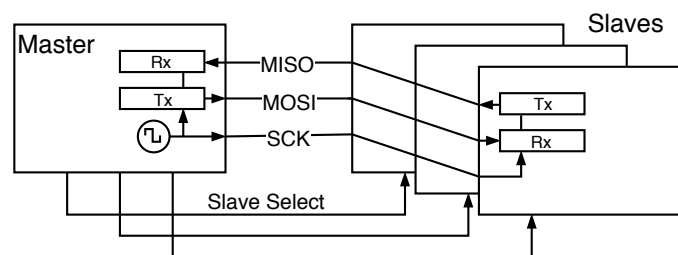

Figure 7.3: A SPI bus with 1 master and 3 slaves, each enabled by its own Slave Select signal

7.2.1 Examples of Devices Using SPI

- **SX1276** – LoRa transceiver
- **nRF24L01+** – 2.4 GHz ISM band radio module
- **L3GD20** – 3-axis gyroscope
- **BMP280** – pressure sensor
- **BME680** – air quality sensor
- **ENC28J60** – Ethernet controller
- **L6470** – intelligent stepper motor driver
- **AD9833** – waveform generator (**MOSI** only)
- **ADE7912** – triple Σ - Δ **ADC** for power metering applications
- **SD cards** [32]
- SPI-interfaced EEPROM and Flash memories

7.3 I²C

Inter-Integrated Circuit (I²C) is a two-wire, open-drain bus that supports multi-master operation. It uses two connections (plus GND): **Serial Data Line (SDA)** and **Serial Clock Line (SCL)**, both open-drain with a pull-up resistor.

The protocol was developed by Philips Semiconductor (now NXP Semiconductors), and its implementors were, until 2006, required to pay licensing fees, leading to the development of compatible implementations with different names, such as Atmel's **Two-Wire Interface (TWI)** or Dallas Semiconductor's "Serial 2-wire Interface" (e.g., used in the DS1307 **Real-Time Clock (RTC)** chip). I²C is a basis of the **System Management Bus (SMBus)** and **Power Management Bus (PMBus)**, which add additional constraints and rules for a more robust operation.

The frame format is shown and explained in **Figure 7.4**; more details may be found in the specification [33] or application notes and datasheets offered by chip vendors, such as the white paper from Texas Instruments [34]. A frame starts with a start condition and stops with a stop condition, defined by an **SDA** edge while the **SCL** is high. The address and data bytes are acknowledged by the slave by sending a 0 on the open-drain **SDA** line in the following clock cycle. A slave can terminate the transaction by sending 1 in place of the acknowledge bit. Slow slave devices may stop the master from sending more data by holding the SCL line low at the end of a byte, a feature called *Clock Stretching*. As the bus is open-drain, the line cannot go high until all participants release it.

Two addressing modes are defined: 7-bit and 10-bit. Due to the small address space, exacerbated by many devices implementing only the 7-bit addressing, collisions between different chips on a shared bus are common; many devices thus offer several pins to let the board designer choose a few bits of the address by connecting them to different logic levels.

The bus supports multi-master operation, which leads to the problem of collisions. Multi-master capable devices must implement a bus arbitration scheme as specified by the I²C standard [33]. This feature is, however, rarely used in practice; the most common topology for I²C is multi-drop single-master, similar to **SPI**, with the advantage of using only two microcontroller pins.

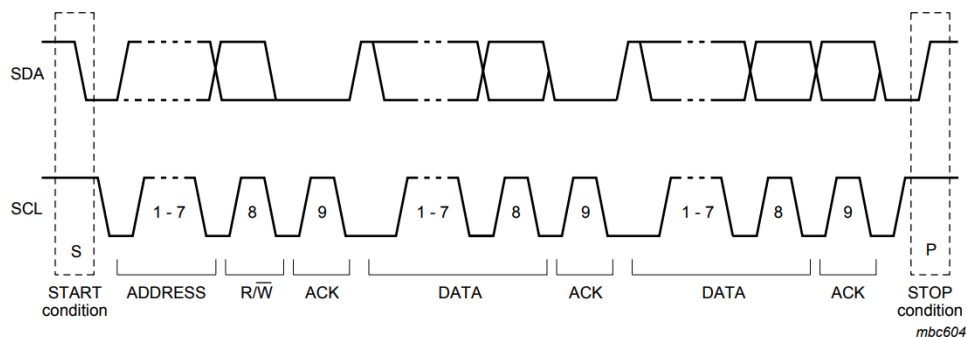

Figure 7.4: An I²C message diagram (taken from the I²C specification [33])

7.3.1 Examples of Devices Using I²C

- **APDS-9960** – ambient light, proximity and gesture sensor
- **L3GD20, BMP280, BME680** – listed as **SPI** devices, those also support **I²C**
- **DS1307** – **RTC**; **I²C** is not mentioned in the entire datasheet, presumably to avoid paying license fees, but it is fully compatible
- **IS31FL3730** – a **light emitting diode (LED)** matrix driver
- The **Serial Camera Control Bus (SCCB)** used to configure camera modules is derived from **I²C**

7.4 1-Wire

The 1-Wire bus, developed by Dallas Semiconductor (acquired by Maxim Integrated), uses a single, bi-directional data line (Figure 7.5), which can also power the slave devices in a *parasitic mode*, reducing the number of required wires to just two (compare with 3 in **I²C** and 5 in **SPI**, all including **GND**). The parasitic operation is possible thanks to the data line resting at a high logic level most of the time, charging an internal capacitor.

1-Wire uses an open-drain connection for the data line, similar to **I²C**, though the protocol demands it to be connected directly to V_{dd} in some places when the parasitic mode is used; this is accomplished using an external transistor, or by reconfiguring the GPIO pin as output and setting it to 1, provided the microcontroller is able to supply a sufficient current.

The communication consists of short pulses sent by the master and (for bit reading) the line continuing to be held low by the slave for a defined amount of time. The pulse timing determines whether it is a read or write operation and which value is encoded. It can be implemented either in software as delay loops, or by abusing a **UART** peripheral, as explained in [35]. Detailed timing diagrams can be found in the DS18x20 [36]. 1-Wire transactions include a checksum byte to ensure an error-free communication.

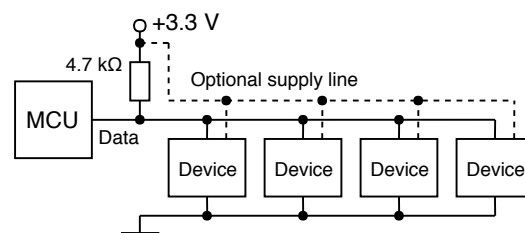

Figure 7.5: 1-Wire connection topology with four slave devices

Devices are addressed by their unique 64-bit ID numbers called ROM codes or ROMs; they can be found by the bus master, with a cooperation from slaves, using a ROM Search algorithm. The search algorithm is explained in [37], including a possible implementation example. If only one device is connected, a wild card command Skip ROM can be used to address the device without a known ROM code.

7.4.1 Examples of Devices Using 1-Wire

- **DS1820**, **DS18S20**, **DS18B20** – digital thermometers
- **iButton** – contact-read access tokens, temperature loggers, etc.

Since 1-Wire is a proprietary protocol, there is a much smaller choice of available devices and they also tend to be more expensive. The DS18x20 thermometers are, however, popular enough to warrant the bus’s inclusion in GEX.

7.5 NeoPixel

NeoPixel is a marketing name of the **WS2812** and compatible intelligent **LED** drivers that are commonly used in “addressable **LED** strips” ([Figure 7.6](#)). These chips include the control logic, PWM drivers and the **LED** diodes all in one 5×5 mm SMD package.

The NeoPixel protocol is unidirectional, using only one data pin. The **LED** drivers are chained together. Ones and zeros are encoded by pulses of a defined length on the data pin; after the color data was loaded into the **LED** string, a longer “reset” pulse (low level) is issued by the bus master and the set colors are displayed. The timing constraints are listed in [Table 7.1](#).

The NeoPixel timing is sensitive to pulse length accuracy; a deviation from the specified timing may cause the data to be misinterpreted by the drivers. Some ways to implement the timing use hardware timers or the [Inter-IC Sound \(I²S\)](#) peripheral. An easier method that does not require any additional hardware resources beyond the **GPIO** pin is to implement the timing using delay loops in the firmware; care must be taken to disable interrupts in the sensitive parts of the timing; it may be advantageous to implement it in assembly for a tighter control.

Table 7.1: NeoPixel pulse timing

Bit value	Constraint	Duration
0	High level	0.4 μ s ± 150ns
0	Low level	0.85 μ s ± 150ns
1	High level	0.45 μ s ± 150ns
1	Low level	0.8 μ s ± 150ns
–	Reset pulse (low)	> 50 μ s

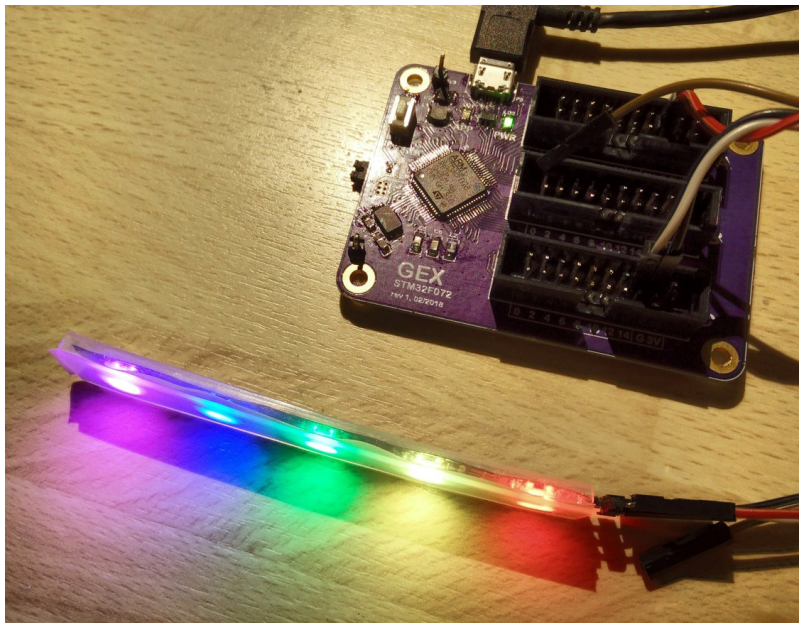

Figure 7.6: GEX prototype driving a strip of 5 NeoPixels

Chapter 8

Non-communication Hardware Functions

In addition to communication buses, described in [Chapter 7](#), GEX implements several measurement and output functions that take advantage of the microcontroller's peripheral blocks, such as timers/counters and [DAC](#). The more complicated ones are described here; simpler functions, such as the raw [GPIO](#) access, will be described later together with their control [API](#).

8.1 Frequency Measurement

Applications like motor speed measurement or the use of sensors with [PWM](#) output demand a tool capable of measuring frequency (and the duty cycle) of a signal. This can be done using laboratory instruments such as the Agilent 53131A. A low-cost solution can be realized using a timer/counter microcontroller peripheral.

Two basic methods to measure frequency exist [[38](#)], each with its advantages and drawbacks:

- The *direct method* ([Figure 8.1](#)) is based on the definition of frequency as a number of cycles n in a fixed-length time window τ (usually 1 s); the frequency is then calculated as $f = n/\tau$.

One timer generates the time window and its output gates the input of another, configured as a pulse counter. At the end of the measurement window an interrupt is generated and we can read the pulse count from the counter's register.

The direct method has a resolution of 1 Hz with a sampling window of 1 s (only a whole number of pulses can be counted). The resolution can be increased by using a longer time window, provided the measured signal is stable enough to make averaging possible without distorting the result. Further increase of precision is possible through analog or digital interpolation [[39](#)], a method used in some professional equipment.

- The *indirect or reciprocal method* ([Figure 8.2](#)) measures one period T as the time interval between two pulses and this is then converted to frequency as $f = 1/T$.

This method needs only one timer/counter. Cycles of the system clock are counted for the duration of one period on the input pin (between two rising edges). If we additionally detect the falling edge in between, the counter's value gives us the duty cycle when related to the overall period length.

The reciprocal method's resolution depends on the counter's clock speed; if driven at 48 MHz, the tick period is 20.83 ns, which defines the granularity of our time

measurement. It is common to measure several pulses and average the obtained values to further increase the precision.

We can easily achieve a sub-hertz resolution with this method, but its performance degrades at high frequencies where the time measurement precision becomes insufficient. The input frequency range can be extended using a hardware prescaler¹, which is also applicable to the direct method, should the measurement of frequencies outside the counter's supported range be required. A duty cycle measurement available in this method can be used to read the output of sensors that use a pulse-width modulation.

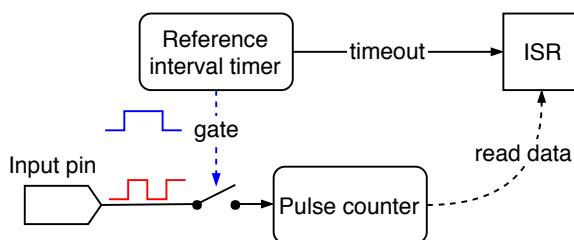

Figure 8.1: Direct frequency measurement method

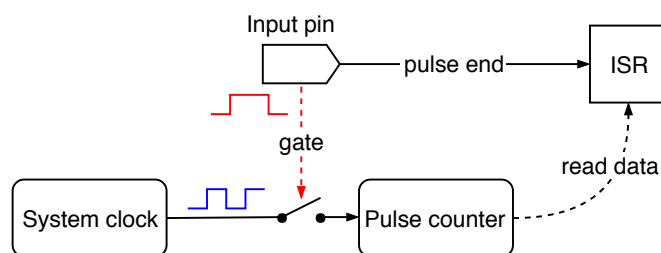

Figure 8.2: Reciprocal frequency measurement method

Which method to use depends on the frequency we want to measure; the worst-case measurement errors of both methods, assuming an ideal 48 MHz system clock, are plotted in [Figure 8.3](#). It can be seen that the reciprocal method leads in performance up to 7 kHz where the direct method overtakes it. If a higher error is acceptable, the reciprocal method could be used also for higher frequencies to avoid a reconfiguration and to take advantage of its higher speed.

A good approach to a universal measurement, for cases where we do not know the expected frequency beforehand, could be to obtain an estimate using the direct method first, and if the frequency is below the worst-case error crossing point (here 7 kHz, according to [Figure 8.3](#)), to take a more precise measurement using the reciprocal method.

The system clock's frequency, which we use to measure pulse lengths and to gate the pulse counter, will be affected by tolerances of the used components, the layout of the PCB, temperature effects etc., causing measurement errors. A higher accuracy could be achieved using a [temperature-compensated oscillator \(TCO\)](#), or, in the direct method, with the synchronization pulse provided by a [GPS](#) receiver to time the measurement interval.

¹*Prescaler* is a divider implemented as part of the timer/counter peripheral block that can be optionally enabled and configured to a desired division factor.

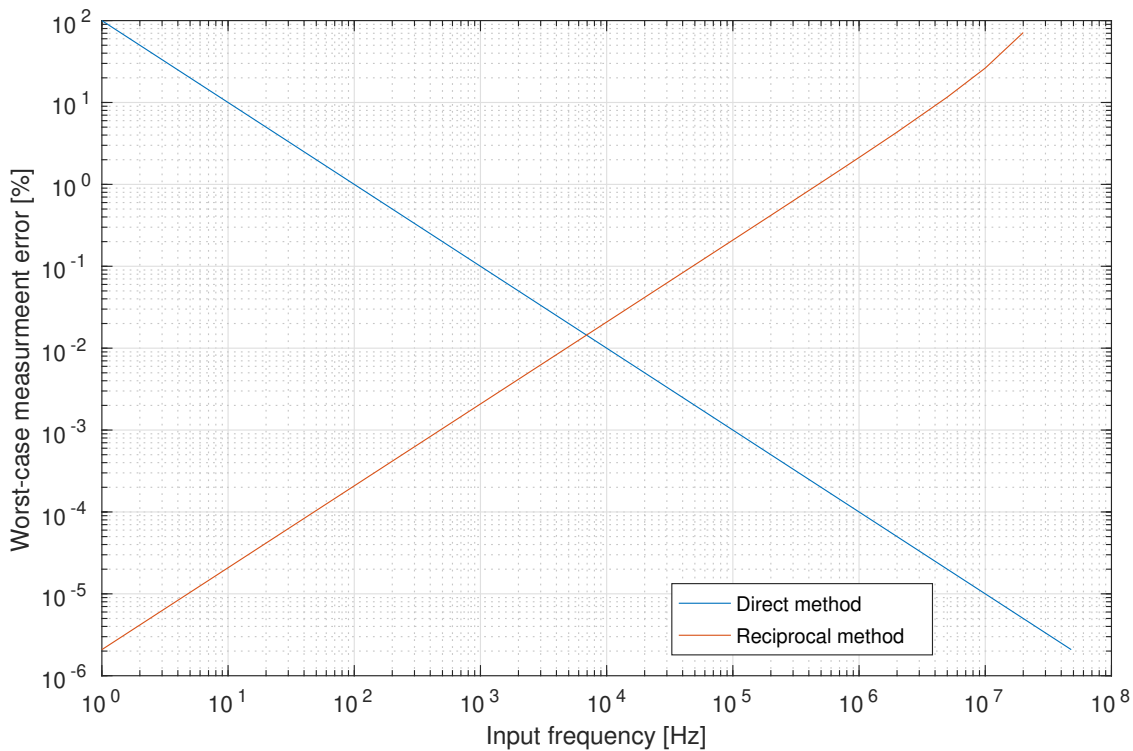

Figure 8.3: Worst-case error using the two frequency measurement methods with an ideal 48 MHz timer clock. The crossing lies at 7 kHz with an error of 0.015 %, or 1.05 Hz.

8.2 Analog Signal Acquisition

A very common need in experiments involving the measurement of physical properties is the acquisition of analog signals, respective voltages. These can be roughly divided into **DC** and **AC** or time-changing signals. Analog signals are converted to digital values using **ADCs**. Several principles of analog signal measurement exist with different cost, speed, resolution, and many other factors which determine their suitability for a particular application.

DC signals can be measured by taking several samples and calculating their average value; in the presence of mains interference (50 Hz or 60 Hz), it is advisable to spread those samples over the 20 ms (resp. 16.7 ms) time of one period, so that the interfering waveform cancels out. Time-changing signals can be captured by taking isochronous samples at a frequency conforming to the Nyquist theorem, that is, at least twice that of the measured signal. In practice, a frequency several times higher is preferred for a more accurate capture.

The **ADC** type commonly available in microcontrollers, including our STM32F072, uses a *successive approximation* method. It is called the *SAR type ADC*, after its main component, the **successive approximation register (SAR)**. A diagram of this **ADC** is shown in Figure 8.4.

The **SAR** type converter uses a **DAC**, controlled by the value in the **SAR**, which approximates the input voltage, bit by bit, following the algorithm described in [40] and outlined below:

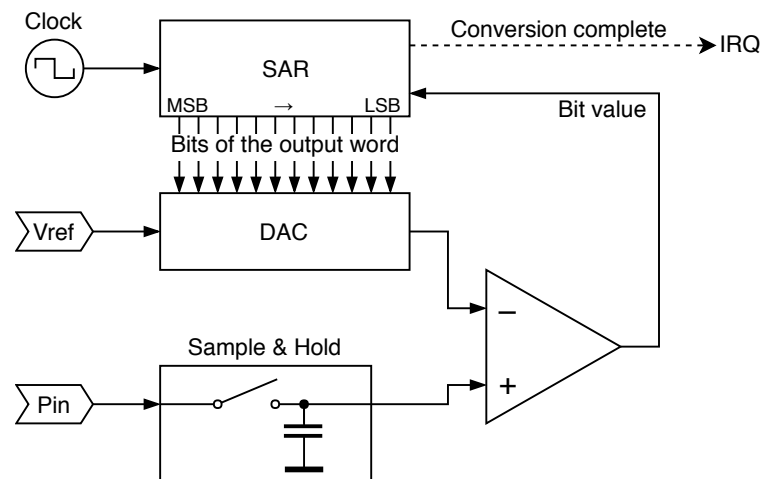

Figure 8.4: A diagram of the SAR type ADC

1. The **SAR** is cleared to all zeros.
2. The **DAC** generates an approximation voltage.
3. Its output is compared with the sampled input, and the comparator's output is stored as the active bit in the approximation register.
4. The approximation continues with step 2 and the following (less significant) bit.
5. After finding all bits of the data word, an **interrupt request (IRQ)** is generated and the application program can read the result from the **SAR**.

A change of the input value would make this principle unreliable, which is why the input is buffered by a sample & hold circuit. The holding capacitor is charged to the input voltage and maintains this level during the conversion. The duration for which the capacitor is connected to the input is called a *sampling time*.

8.3 Waveform Generation

A waveform generator is a useful tool in many experiments and measurements. A sine stimulus is the basis of a lock-in amplifier; it can be used to measure impedance; with a frequency sweep, we can obtain the frequency response of an analog filter, etc. We can, of course, generate other waveforms, such as a triangle, ramp, or rectangle wave.

The **DAC** peripheral can produce a **DC** level on the output pin based on a control word. When we periodically change its digital input, it produces an analog waveform.

8.3.1 Waveform Generation with DMA and a Timer

A straightforward, intuitive implementation of the waveform generator is illustrated in **Figure 8.5**. This approach has its advantages: it is simple and works autonomously, with

no interrupt handling or interventions from the program. It could be implemented without the use of **Direct Memory Access (DMA)** as well, using a loop periodically updating the **DAC** values; of course, such approach is less flexible and we would run into problems with interrupt handling affecting the timing accuracy.

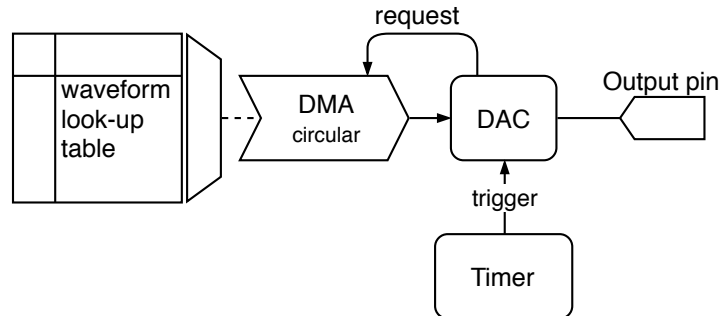

Figure 8.5: A simple implementation of the waveform generator, using DMA and a look-up table

The highest achievable output frequency largely depends on the size of our look-up table. For instance, assuming a timer frequency of 48 MHz and a 8192-word table, holding one period of the waveform, the maximum frequency would be short of 6 kHz, whereas if we shorten the table to just 1024 words, we can get almost 47 kHz on the analog output. The downside of a shorter table is a lower resolution, which will appear as **DC** plateaus or steps when observed with an oscilloscope, producing harmonic components similar to those of a square wave.

A major disadvantage of this simple generation method is given by the limitations of the used timer, which defines the output frequency. Its output trigger fires when the internal counter reaches a predefined value, after which the counting register is reset. The counting speed is derived from the system clock frequency f_c using a prescaler P and the set maximum value N . Only output frequencies that can be exactly expressed as $f = f_c / (P \cdot N \cdot \text{TableSize})$ can be accurately produced. Still, this simple and efficient method may be used where fine tuning is not required to take advantage of its fully asynchronous operation.

8.3.2 Direct Digital Synthesis

There are situations where the simple waveform generation method is not sufficient, particularly when fine tuning, or on-line frequency and phase changes are required. Those are the strengths of **Direct Digital Synthesis (DDS)**, an advanced digital waveform generation method well explained in [41].

A diagram of a possible **DDS** implementation in the STM32 firmware is shown in **Figure 8.6**. It is based on a **numerically controlled oscillator (NCO)**. The **NCO** consists of a *phase accumulator* register and a *tuning word* which is periodically added to it at a constant rate in a timer interrupt handler. The value of the tuning word determines the output waveform frequency. The look-up table must have a power-of-two length so that it can be addressed by the n most significant bits of the phase accumulator. An additional control word could be added to this address to implement a phase offset for applications like a phase-shift modulation.

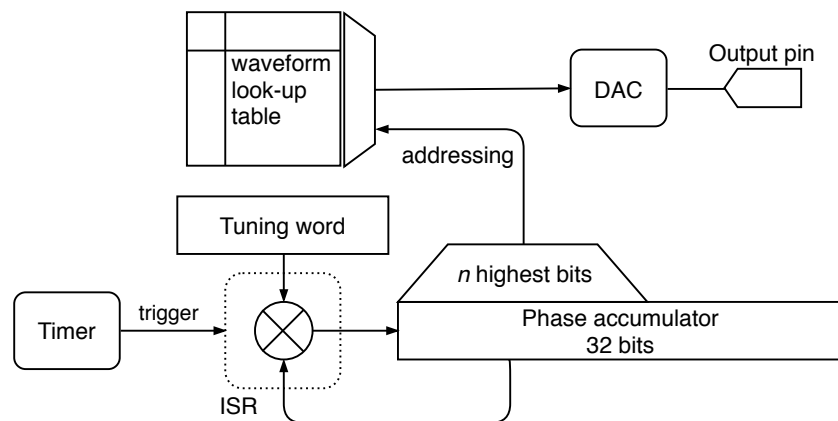

Figure 8.6: A block diagram of a DDS-based waveform generator

The output frequency is calculated as $f_{\text{out}} = \frac{M \cdot f_c}{2^n}$, where M is the tuning word, n is the bit length of the phase accumulator, and f_c is the frequency of the phase-updating interrupt. The number of bits used to address the look-up table does not affect the output frequency; the table can be as large as the storage space allows. A tuning word value exceeding the lower part of the phase accumulator (including bits which directly enter the look-up address) will cause some values from the table to be skipped. A smaller tuning word, conversely, makes some values appear at the output more than once. This can be observed as steps or flat areas on the output. When the tuning word does not evenly divide 2^n , that is, the modulo is non-zero, we can also observe jitter.

■ DDS Implemented in Hardware

DDS may be implemented in hardware, including the look-up table, often together with the DAC itself, which is then called a *Complete DDS*. That is the case of, e.g., the AD9833 from Analog Devices. As the software implementation depends on a periodic interrupt, it is often advantageous to use a component like this when we need higher output frequencies where the use of an interrupt is not possible. GEX can control an external waveform generator like the AD9833 using an SPI port.

■ 8.4 Touch Sensing

The STM32F072 microcontroller includes a **Touch Sensing Controller (TSC)** peripheral block. This device is meant to be used in touch-based user interfaces, e.g., for kitchen appliances or toys. We include it in GEX to serve as a demonstration of capacitive touch sensing, and it could possibly be used for simple capacitive sensors as well, such as a water level measurement.

The TSC requires a specific topology with a sampling capacitor connected close to the microcontroller pin, which may not be possible on a universal GEX module; for this reason, the touch sensing feature is best demonstrated on the STM32F072 Discovery development kit, which includes a 4-segment touch slider shown in **Figure 8.7**.

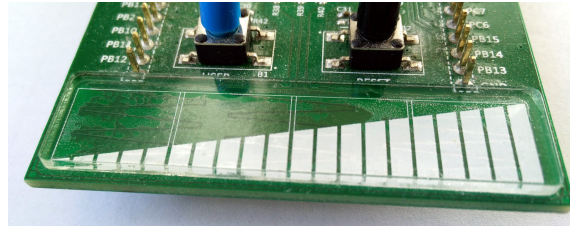

Figure 8.7: The touch slider on a STM32F072 Discovery board

The principle of capacitive touch sensing using the **TSC** is well explained in the microcontroller's reference manual [42], the **TSC** product training materials [43, 44] and application notes from ST Microelectronics [45, 46, 47, 48]. A key part of the **TSC** is a set of analog switches which can be combined to form several different signal paths between external pins, V_{DD} , **GND**, and an analog comparator. Two input pins are needed for every touch sensing channel: the sensing pad connects to one, the other is connected through a sampling capacitor (47 nF on the Discovery board) to **GND**.

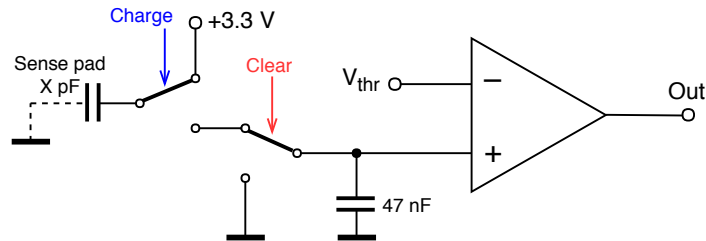

Figure 8.8: A simplified schematic of the touch sensing circuit

Capacitive sensing is a sequential process described in the following steps:

1. The sampling capacitor is discharged by connecting its free end to **GND**.
2. The sensing pad is connected to V_{DD} (+3.3 V) and, acting as a capacitor, charged to this voltage. It stores a small amount of charge, depending on its capacitance—this is the variable property we are trying to measure.
3. The free terminals of the two capacitors (the sensing pad and the sampling capacitor) are connected together and their voltages reach an equilibrium as a portion of the stored charge leaves the sensing pad and flows into the bigger capacitor.
4. The steps (2) and (3) are repeated until the sampling capacitor's voltage exceeds a fixed threshold (set to a half of the supply voltage). The number of cycles needed to charge the sampling capacitor corresponds to the capacitance of the sensing pad.

A real voltage waveform measured on the sensing pad using an oscilloscope is shown in **Figure 8.9**.

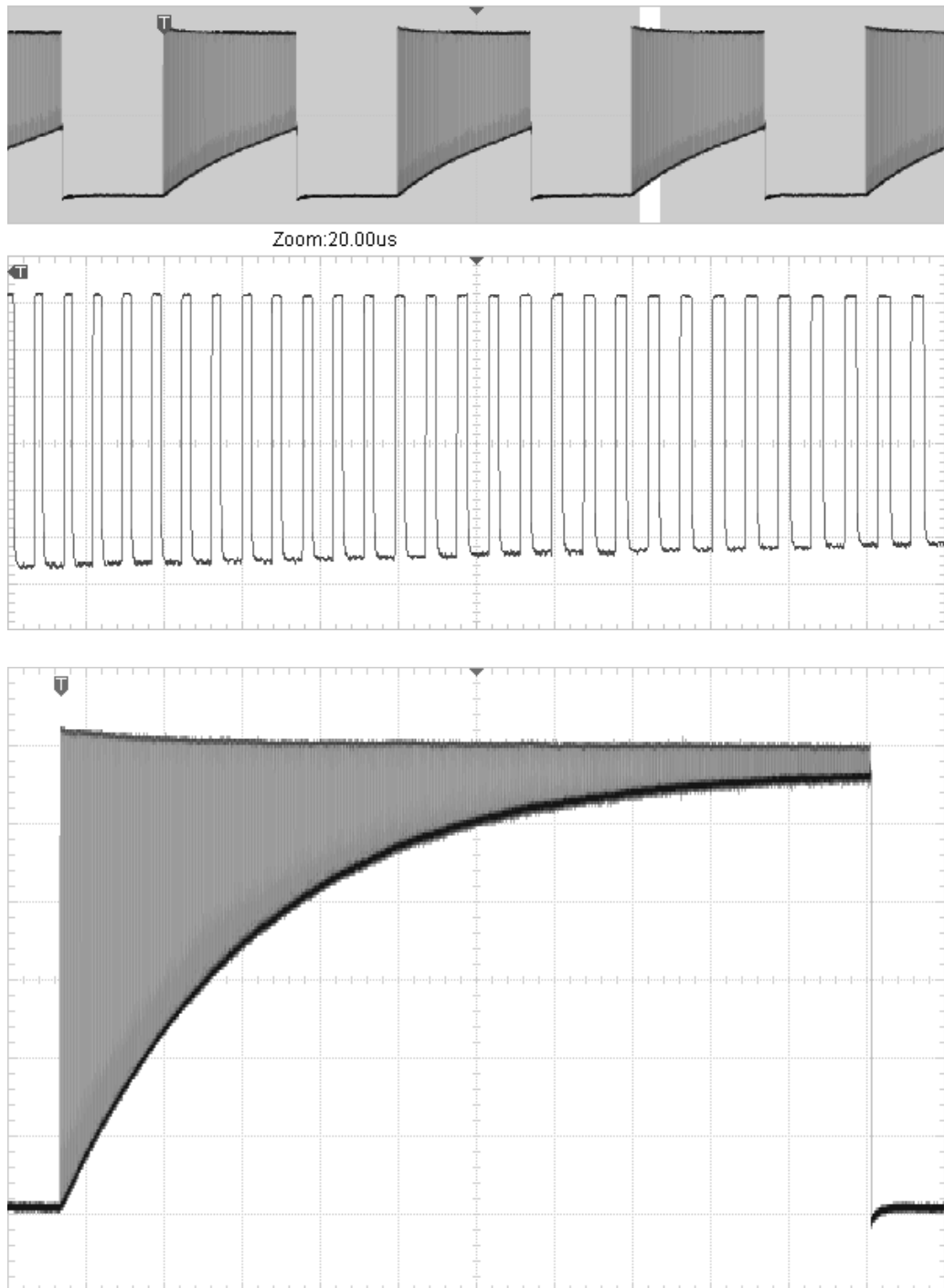

Figure 8.9: A voltage waveform measured on the touch sensing pad. The bottom side of the envelope equals the sampling capacitor’s voltage—this is the phase where both capacitors are connected. The detailed view (middle) shows the individual charging cycles. The bottom screenshot captures the entire waveform, left to continue until a timeout, after the analog comparator was disabled.



Part III

Implementation

Chapter 9

Conceptual Overview

GEX is designed to be modular and easy to extend. The user-facing functionality is composed of independent software modules, called *functional blocks* or *units*, which can be configured by the user to fit their application needs. Units implement low-level logic to work with hardware peripherals of the microcontroller, and expose this functionality to the client application, running on the PC, through a communication interface. A diagram showing the entire stack, from the user application down to hardware peripherals, is shown in [Figure 9.1](#).

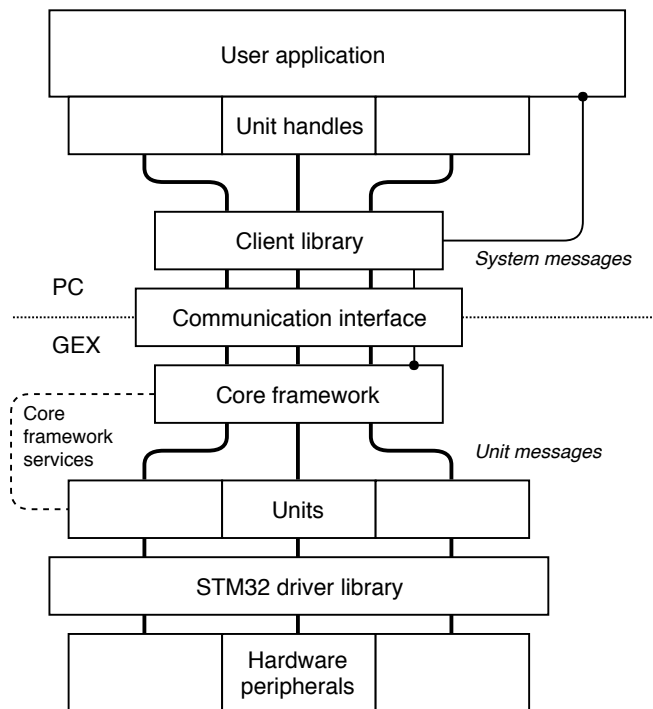

Figure 9.1: The “GEX stack”, from a user application down to hardware

When we work with GEX, it is through units. The platform without units would be just an empty shell, the bare core framework; this underlying system will be described in [Chapter 10](#). We will explore the individual units in [Chapter 13](#), after going through the hardware realizations in [Chapter 15](#) and covering the communication protocol in [Chapter 12](#).

9.1 Physical User Interface

The firmware can be flashed to a STM32 development board, or a custom **PCB**. The particulars of those form factors will be discussed in [Chapter 15](#).

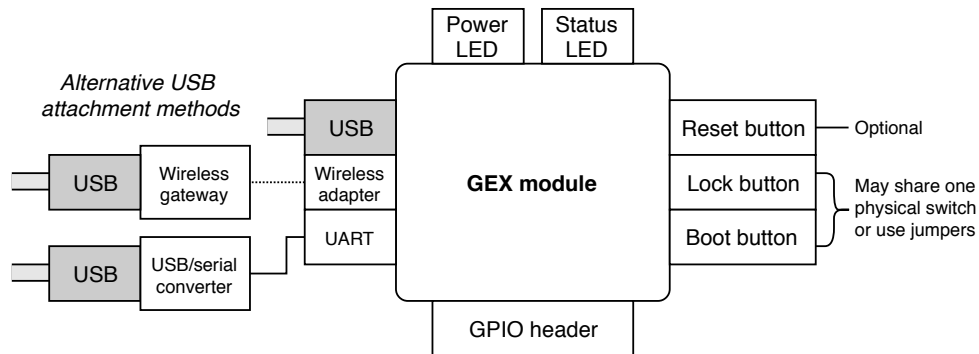

Figure 9.2: Physical user interface of a GEX module

All GEX hardware platforms have some common characteristics ([Figure 9.2](#)):

- **Power LED** – a simple indication that the board is powered on
- **Status LED** – periodic flashing every 3s indicates correct operation, continuous light a software error¹; other light patterns may be shown as feedback to user actions or received commands
- **Reset button** – resets the **MCU**; this is particularly useful during firmware development as an alternative to re-connecting the **USB** cable
- **Lock button** – enables or disables access to configuration files through the virtual mass storage device
- **Boot button** – when held during restart (that is, while the reset button is released), the **Device Firmware Update (DFU)** mode [49] is activated and a new firmware image can be flashed over the **USB** connection using `dfu-util` [50] or other firmware update application
- **GPIO header** – a pin header exposing the **MCU**'s **GPIO** pins to be connected to external circuitry
- **Communication interface** – a connection to the host **PC**; multiple options may be available to choose from, a direct **USB** connection being the primary and always available option

9.2 GEX-PC Connection

[Figure 9.2](#) shows three ways to connect the module to a **PC**. Each communication interface has its advantages and drawbacks, and is suitable for different use-cases.

¹The microcontroller will then automatically restart within a few seconds due to a watchdog timeout.

- **Direct USB connection**

This is the primary and most straightforward connection method. We use the **CDC/ACM** and **MSC USB** classes to have the module appear as a virtual COM port and a mass storage device, as described in [Section 4.3](#). This method is the fastest of the three and works out-of-the-box on Linux and MacOS. On MS Windows it may require the right software driver to be installed and assigned manually².

- **Hardware UART**

The hardware UART used as a communication interface is mapped to pins PA2 and PA3 to be compatible with the built-in **USB/UART** converter on STM32 Nucleo development boards. This interface is functionally identical to the **CDC/ACM** connection, but the physical **UART** is necessarily slower and does not implement flow control.

- **Wireless connection**

A wireless connection is implemented using a radio module on the GEX board. To use it we need a counterpart, the *wireless gateway*, which connects to the **PC** via **USB** and acts as a **CDC/ACM** device.

The **USB** connection is always enabled first on start-up. GEX waits its for enumeration by the host **PC**. When not enumerated in a few seconds, it concludes that the interface is not active and tries other enabled options. The wireless module, connected through **SPI**, can be detected by reading one of its registers that should have a known value. A **UART** interface cannot be tested so reliably, thus it is always considered active³.

9.3 Controlling GEX

GEX is a platform providing access to low-level hardware to high-level applications. However, this “high level” is relative. As was shown in [Figure 9.1](#), the “GEX stack” ends with a *client library*, a software library used by the *user application*.

The communication protocol (one level lower in the diagram), which will be explained in [Chapter 12](#), may be implemented as part of the client library in any programming language and on any platform; in theory, it is even possible to control GEX from another microcontroller. The client library implements, besides the protocol itself, other higher-level logic, and gives the user access to individual units using an abstraction called *unit handles*.

Any logic above the client library is in the hands of the user, which means that, to use GEX, they have to program a user application. Proof-of-concept client libraries in languages C and Python are provided for this purpose, and will be explained in [Chapter 16](#).

²The STM32 virtual COM port driver [51] has been tested to work with GEX on MS Windows version 7 and 8, though it must be manually assigned to the device in the Device Manager. MS Windows 10 and later should support **CDC/ACM** as a virtual COM port natively.

³A detection of the UART connection would be possible by measuring the Rx pin voltage, which should idle at a high level (here 3.3 V). This was not implemented in the initial firmware version.

9.4 Device Configuration

The core framework and each of the units have a number of adjustable options determining their behavior. Those settings are internally stored in a binary form, but to make their adjustment comfortable for the user, they are mapped to text configuration files in the INI format.

9.4.1 INI File Format

INI files are, in our implementation, simple text files containing three basic syntax elements: comments, sections, and key-value entries. Sections group the key-value pairs into logical blocks, e.g., the configuration of individual units.

- **Comments** start with the hash symbol (#) and end at the end of line
- **Sections** are textual labels enclosed in square brackets ([UNITS])
- **Key-value entries** are composed of a label, the equals sign, and its value; values may be text strings, decimal or hexadecimal numbers, lists of numbers separated by commas, or any other format appropriate for the particular key

An example of the INI syntax is shown below.

```
# comment
[section]
a = 123
b = 0xFF
port = A
pins = 1,2,3
```

9.4.2 Configuration Files Structure

The configuration is split into two files: `UNITS.INI` and `SYSTEM.INI`. The system configuration file has a simple structure and does not need much explanation beyond the comments already included in it; an example of its content is captured in [Listing 1](#). The other file, as its name suggests, serves to configure GEX units.

The units file, illustrated in [Listing 2](#), is more complex, and *interactive*. The top part, a [UNITS] section, lists all available unit types. A unit is created by writing its name (an arbitrary label composed of letters, numbers, and underscore) next to the desired type. Each unit is then configured in a separate section lower in the file; however, how does one know what keys are needed for which unit? This problem is solved by *interactivity* of the file.

After adding a unit name next to its type, we save the file. The disk temporarily disappears from the device list as the file's content updates. When we reopen the file, a

```

## SYSTEM.INI

[SYSTEM]
# Data link accessible as virtual comport (Y, N)
expose-vcom=Y
# Show comments in INI files (Y, N)
ini-comments=Y
# Enable debug UART-Tx on PA9 (Y, N)
debug-uart=Y

# Output core clock on PA8 (Y, N)
mco-enable=N
# Output clock prediv (1,2,...,128)
mco-prediv=128

# --- Allowed fallback communication ports ---

# UART Tx:PA2, Rx:PA3
com-uart=N
com-uart-baud=115200

# nRF24L01+ radio
com-nrf=N
# Radio channel (0-125)
nrf-channel=76
# Network prefix (hex, 4 bytes)
nrf-network=12:00:09:4C
# Node address (1-255)
nrf-address=1

```

Listing 1: The SYSTEM.INI configuration file

section for the new unit will be appended for us to configure as necessary. To delete a unit, it is sufficient to remove its name from the list at the top and let the file regenerate the same way; the unit's section will disappear.

It is not uncommon that the entered (or default) configuration is invalid and the unit cannot be enabled. The error is reported by inserting a comment into the INI file, at the top of the section of the failing unit. This error message disappears when the problem is corrected.

Once we are satisfied with the configuration, it may be stored to the module's permanent memory. This is done by pushing the Lock button again, which also deactivates the virtual storage device.

It may be interesting to know that the configuration files can also be read and modified through the communication interface. A simple configuration editor ([Figure 9.3](#)) was

```
## UNITS.INI

[UNITS]
# Create units by adding their names next to a type (e.g. DO=A,B),
# remove the same way. Reload to update the unit sections below.

# Digital output
DO=led
# Digital input with triggers
DI=btn1,btn2
# Neopixel RGB LED strip
NPX=
# I2C master
I2C=i2c
#...

[I2C:i2c01]
# Peripheral number (I2Cx)
#...
```

Listing 2: Part of the UNITS.INI configuration file

developed to demonstrate this feature. Besides applications like this, we can use the programmatic configuration access to change GEX settings automatically by the client application. The changes may be persisted by a command, but that is not required, which lets us use them temporarily without modifying the stored configuration.

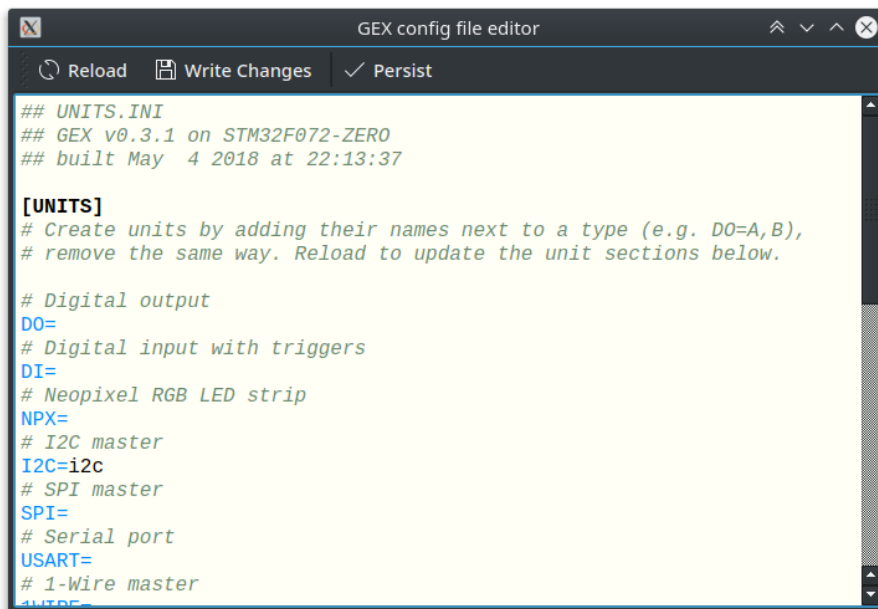

```
## UNITS.INI
## GEX v0.3.1 on STM32F072-ZERO
## built May  4 2018 at 22:13:37

[UNITS]
# Create units by adding their names next to a type (e.g. D0=A,B),
# remove the same way. Reload to update the unit sections below.

# Digital output
D0=
# Digital input with triggers
DI=
# Neopixel RGB LED strip
NPX=
# I2C master
I2C=i2c
# SPI master
SPI=
# Serial port
USART=
# 1-Wire master
1WIRE=
```

Figure 9.3: Configuration file editor GUI built using the GEX client library and PyQt4

Chapter 10

Internal Application Structure

The firmware is built around a *core framework* which provides services to units, such as the settings storage, resource allocation, message delivery, and periodic updates. In this chapter, we will focus on the structure of this framework and the services provided by it.

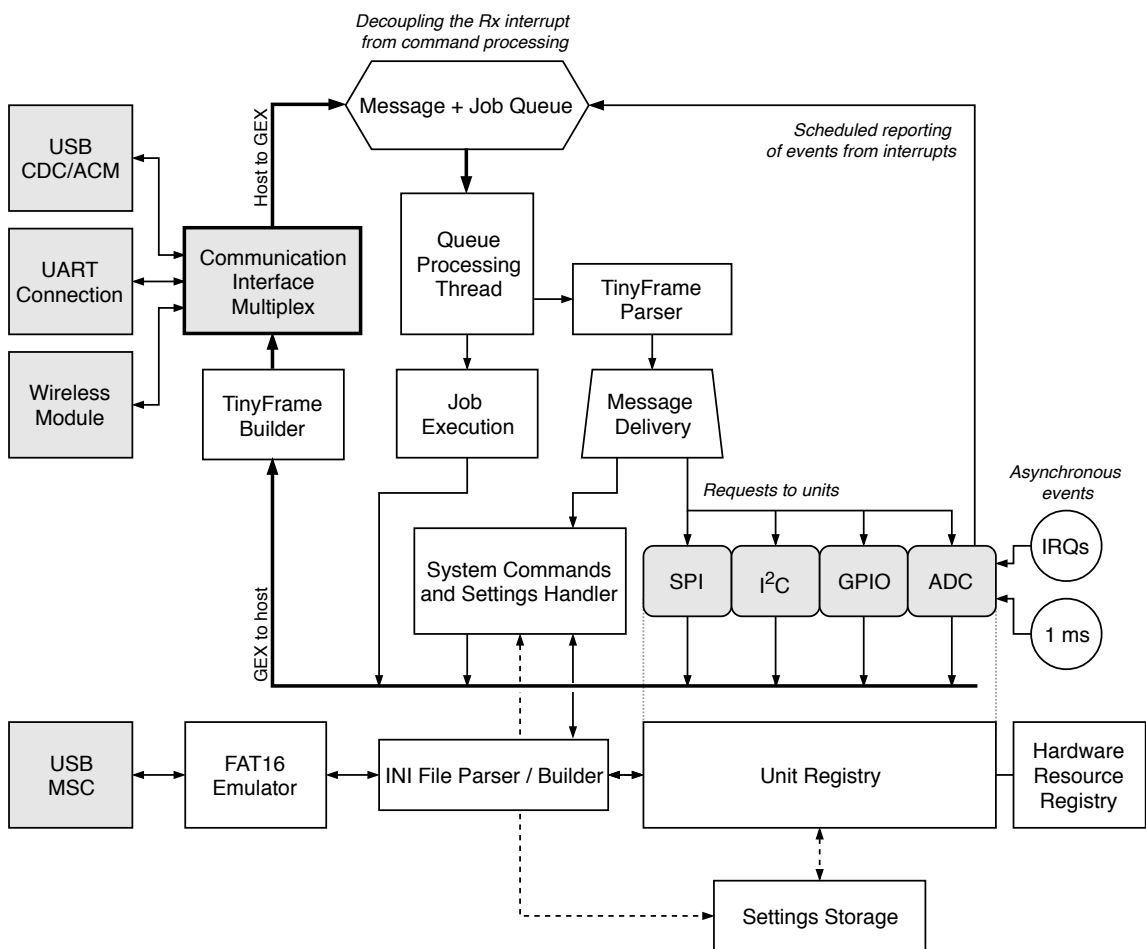

Figure 10.1: Block diagram showing the internal logic in the GEX firmware

10.1 Internal Structure Block Diagram

The data flows and other internal logic of the firmware are depicted in [Figure 10.1](#), with more explanation following in this chapter. The interchangeable role of the three communication interfaces can be clearly seen in the diagram, as well as the central role of the message queue, which decouples interrupts from the processing thread.

The framework provides the following services to units:

- Hardware resource allocation ([Section 10.3](#))
- Settings storage and loading ([Section 10.4](#))
- Unit life cycle management ([Section 10.2](#))
- Message sending and delivery ([Section 10.5](#))
- Interrupt routing ([Section 10.6](#))

10.2 Unit Life Cycle and Internal Structure

GEX's user-facing functions, units, are implemented in *unit drivers*. Those are independent modules in the firmware that the user can enable and configure, in one or more instances. In practice, we are limited by hardware constraints: i.e., there may be only one [ADC](#) peripheral, or two [SPI](#) ports. The assignment of those hardware resources to units is handled by the *resource registry* ([Section 10.3](#)).

Each unit is identified by a name and a *callsign*, which is a number that serves as an address for message delivery. A unit is internally stored as a data object with the following structure:

- Name
- Callsign (one byte)
- Configuration parameters loaded from the unit settings
- State variables updated at run-time by user commands or internal functions
- A reference to the unit driver

The unit driver handles commands sent from the host [PC](#), initializes and de-initializes the unit based on its settings, and implements other aspects of its function, such as periodic updates and interrupt handling.

When the units configuration file is modified, all units are de-initialized and removed. The binary settings are then updated based on the new values, verifying that the requested resources are available, and the units that can be enabled are subsequently initialized and made available to the user.

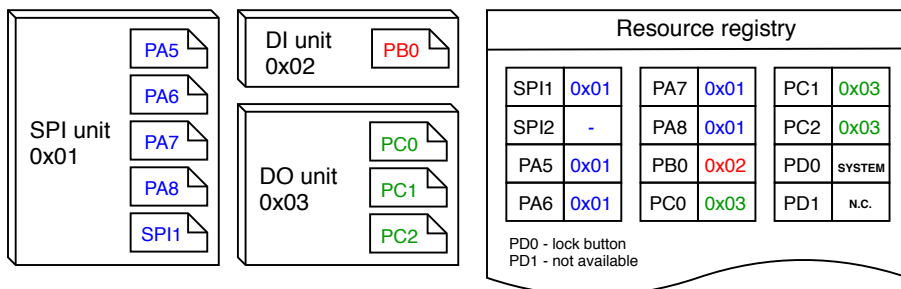

Figure 10.2: An example allocation in the resource registry

10.3 Resource Allocation

The microcontroller provides a number of hardware resources that require exclusive access: GPIO pins, peripheral blocks (SPI, I²C, UART...), and DMA channels. If two units tried to control the same pin, the results would be unpredictable; similarly, the output of a multiply-accessed serial port could become a useless mix of the different data streams.

To prevent multiple access, the firmware includes a *resource registry* (Figure 10.2). Each individual resource is represented by a field in a resource table together with its owner's call sign. Initially all resources are free, except for those not available on the particular platform (e.g., a GPIO pin PD1 may be disabled if not present on the microcontroller's package).

The resources used by the core framework are taken by a virtual unit SYSTEM on start-up to prevent conflicts with the user's units. This is the case of the status LED, the Lock button, USB pins, the communication UART, the pins and an SPI peripheral connecting the wireless module, pins used for the crystal oscillator, and the timer/counter which provides the system timebase.

10.4 Settings Storage

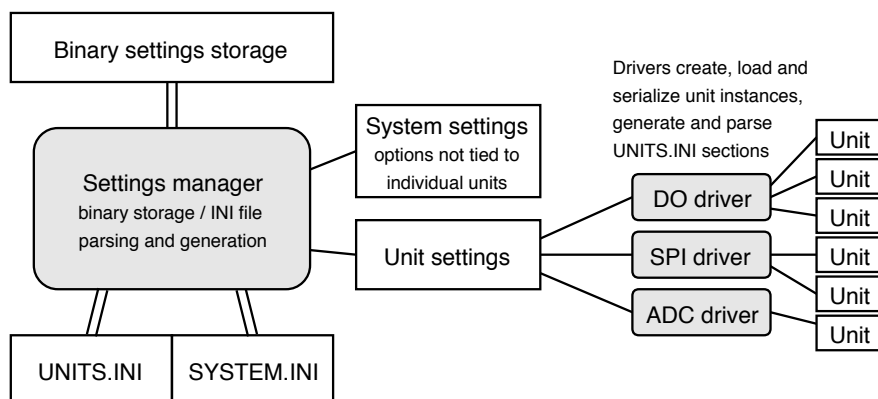

Figure 10.3: Structure of the settings subsystem

The system and unit settings are stored, in a binary form, in designated pages of the microcontroller's flash memory. The serialization and parsing of unit settings is implemented by the respective unit drivers. **Figure 10.3** shows the organization of the settings subsystem; note that the "Settings manager" block has been omitted in **Figure 10.1** for clarity, to better represent the data flows.

The settings persist in the flash memory even after a firmware update, which might add or remove some data fields, or otherwise rearrange the binary structure. Assuming the general layout remains unchanged, this mainly concerns the data areas holding unit (and system) settings. Backward compatibility is achieved by prefixing each storage area with its version number. When the settings are loaded by an updated firmware, it always first checks the version field and decides which format to use to parse the saved data.

10.5 Message Passing

One of the key functions of the core framework is to deliver messages from the host **PC** to the right units. The *TinyFrame* protocol is used, described in detail in **Chapter 12**; it is represented by the "TinyFrame Parser" and "TinyFrame Builder" blocks in **Figure 10.1**¹.

Two groups of messages exist: *system messages* and *unit messages*. System messages can, for instance, access the INI files, or request a list of available units. Unit messages are addressed to a particular unit, and their payload format is defined by the unit's driver. An incoming message is inspected and delivered to the appropriate recipient, or responded to with an error message.

In addition to message delivery, the core framework also provides event reporting. Events are messages generated by units and sent to the host to notify it about asynchronous events.

This high-level functionality resides above the framing protocol, which will be described in **Chapter 12**. The message format is shown in **Section 12.7**.

10.6 Interrupt Routing

Interrupts are an important part of almost any embedded application. They provide a way to rapidly react to asynchronous external or internal events, temporarily leaving the main program, jumping to an interrupt handler routine, and then returning back after the event is handled. Interrupts are also the way FreeRTOS implements multitasking without a multi-core processor.

In Arm Cortex-M0 the interrupt handlers table, defining which routine is called for which interrupt, is stored in the program memory and cannot be changed at run-time. This is a complication for the modular structure of GEX where different unit drivers may use the same peripheral, and we would want to dynamically assign the interrupt handlers based on the active configuration.

¹The framing library is not split into those two blocks in the source code, but the parts are functionally independent

Let us have a look at a sample interrupt handler, in this case serving four different **DMA** channels, as is common in STM32 microcontrollers:

```
void DMA1_Channel4_5_6_7_IRQHandler(void)
{
    if (LL_DMA_IsActiveFlag_GI4(DMA1)) { /* handle DMA1 channel 4 */ }
    if (LL_DMA_IsActiveFlag_GI5(DMA1)) { /* handle DMA1 channel 5 */ }
    if (LL_DMA_IsActiveFlag_GI6(DMA1)) { /* handle DMA1 channel 6 */ }
    if (LL_DMA_IsActiveFlag_GI7(DMA1)) { /* handle DMA1 channel 7 */ }
}
```

It is evident that multiple units might need to use the same handler, even at the same time, since each **DMA** channel is configured, and works, independently. GEX implements a redirection scheme to accomplish such interrupt sharing: all interrupt handlers are defined in one place, accompanied by a table of function pointers. When a unit driver wants to register an interrupt handler, it stores a pointer to it in this redirection table. Then, once an interrupt is invoked, the common handler checks the corresponding entry in the table and calls the referenced routine, if any. Conversely, when a unit driver de-initializes a unit, it removes all interrupt handlers it used, freeing the redirection table slots for other use.

10.7 FreeRTOS Synchronization Objects Usage

The firmware is built around FreeRTOS ([Chapter 5](#)) and a number of its synchronization objects and patterns are used to make its operation more robust.

10.7.1 Message and Job Queue

The message and job queue, seen in [Figure 10.1](#), is used to decouple asynchronous interrupts from message transmission. All three communication interfaces use interrupts for the asynchronous handling of incoming messages. The same interrupt handler receives an event after a transmission was completed. The queue ensures that messages can be received during the transmission of a large response that demands the use of multiple messages.

10.7.2 Lock Objects

The “transmission complete” interrupt signals the readiness to transmit more data to the message-sending task using a binary semaphore. This semaphore is taken by the task before sending a block of data, and released by the **ISR**, ensuring that the task waits for the transmission to complete before attempting to send more data.

Two mutexes are used in the firmware: one that guards access to the TinyFrame Builder until the previous message was fully transmitted, and one to guard a shared memory buffer (reused in several places to save memory and avoid its re-allocation). The hardware resource registry (explained in [Section 10.3](#)) does not need mutexes for individual resources, as concurrent access to those fields can never happen thanks to the way the system is organized; resources are always taken or released sequentially by the same task.

Chapter 11

Working with the GEX Source Code

Understanding the GEX source code layout is important before attempting to implement any changes or to port it to a different microcontroller type. The directory layout is shown in [Figure 11.1](#).

The GEX core framework resides in the User folder, and units are defined in User/units. Each unit driver must be registered in the file `platform.c`. The header file `plat_compat.h` defines platform-specific constants and macros, defining parameters such as pin assignments or the clock speed. The User folder is actually a Git submodule called “gex-core” and is kept as a separate project; platform-specific customizations are managed using compile flags passed from the Makefile.

11.1 Porting to a New Platform

When porting GEX to a new platform, the basis of the project can be generated by the STM32CubeMX code generator [52], using the Makefile output preset. We have to enable FreeRTOS, select a USB class (the choice does not matter, e.g., **CDC/ACM** can be used), and configure the system clock.

The configuration dialog gives a choice between the LL (Low Level) and HAL driver libraries; the HAL library uses a lot of program memory and often contains software bugs, while the LL library is leaner but harder to use. The LL library was used in the STM32F072 port for its smaller size.

Some files generated by STM32CubeMX were moved into the User folder (e.g., the FreeRTOS configuration and initialization, or the system time base generation), as they are mostly platform-independent. The modified **USB** Device library was copied here as well, as it had to be modified to support the definition of a composite class with custom descriptors.

The rest of the porting process, after generating the base project, can be summarized in the following bullet points. These are written as a checklist for the developer working on a

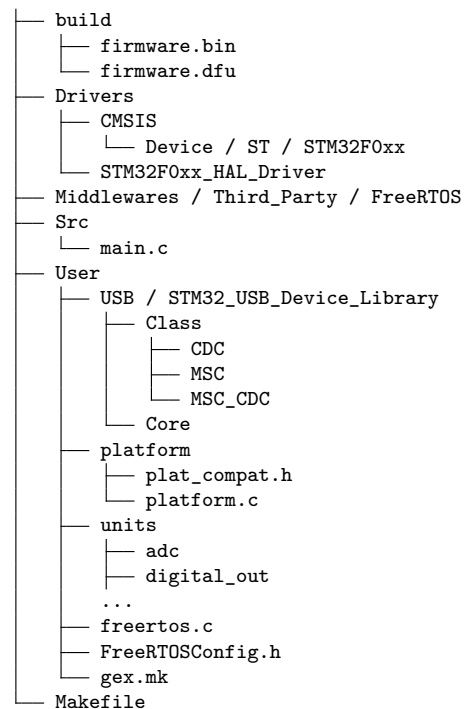

Figure 11.1: General structure of the source code repository

- Update other platform-dependent code (such as the debug **UART** configuration). The compiler should warn about those occurrences when trying to build the project.
- Try to build the project by running “make” in the terminal.

After the firmware successfully compiles, we can flash it to the **MCU** using ST-Link by running “make flash”, or through the **DFU** interface with “make dfu”.

The first thing to verify after flashing the firmware is that the debug **UART**’s configuration is correct and we can see the log output, which should be available on pin PA9 at 115200 baud. Thanks to a generous usage of assertions, most errors should produce helpful log messages in the log. We can then proceed to experiment with the device, testing the features described in **Chapter 9** while observing the debug log for any anomalies.

Chapter 12

Communication Protocol

GEX can be controlled through a hardware **UART**, the **USB**, or over a wireless link. To minimize the firmware complexity, all the three connection methods use the same binary messaging protocol and are functionally interchangeable.

GEX uses the *TinyFrame* [53] framing library, developed, likewise, by the author, but kept as a separate project for easier re-use in different applications. The library implements frame building and parsing, including checksum calculation, and provides high-level **API**.

Both peers, GEX and the client library running on the host **PC**, are at an equal level: either side can independently send a message at any time. The communication is organized in transactions; a transaction consists of one or more messages going in either direction. A message can be stand-alone, or chained to another, typically a request, using the frame ID field; this is the major advantage over text-based protocols, like AT commands, where all messages are independent and their relation to each other is not always clear.

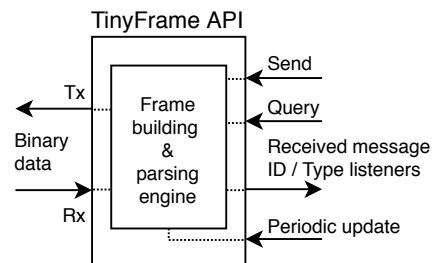

Figure 12.1: TinyFrame API

12.1 Binary Payload Structure Notation

Binary payloads are described in several places of this text. We use a shortened notation derived from the C language to represent field data types:

- **bool** – 8-bit field allowing values 0 (false) and 1 (true)
- **u8**, **u16**, **u32** – unsigned 8-, 16-, or 32-bit integer
- **i8**, **i16**, **i32** – signed (two’s complement) 8-, 16-, or 32-bit integer
- **char** – an 8-bit ASCII character
- **float** – single-precision (32-bit) IEEE 754 [54] floating point number
- **double** – double-precision (64-bit) IEEE 754 [54] floating point number
- **u8[]** – array of variable length
- **u8[n]** – array of length n
- **cstring** – zero-terminated character string (like **char[]**, ending with a 0x00 byte)

12.2 Frame Structure

Message frames have the following structure (all little-endian):

<i>“TinyFrame” frame structure, as used in GEX</i>
<ul style="list-style-type: none"> • 0x01 start-of-frame marker • u16 frame ID • u16 payload length • u8 frame type • u8 header checksum • u8[] payload • u8 payload checksum (omitted for empty payloads)

Frame ID, which could be better described as *Transaction ID*, uniquely identifies each transaction. The most significant bit is set to a different value in each peer to avoid ID conflicts, and the rest of the ID field is incremented with each initiated transaction.

12.3 Message Listeners

After sending a message that should receive a response, the peer registers an *ID listener* with the ID of the sent message. A response reuses the original frame ID and when it is received, this listener is called to process it. ID listeners can also be used to receive multi-part messages re-using the original ID.

Frame type describes the payload and does not have any prescribed format in TinyFrame; its values are defined by the application. A *type listener* may be registered to handle all incoming messages with a given frame type. It works in a similar way to an ID listener, but has a lower priority.

Each message can be handled by only one listener, unless the listener explicitly requests it to be passed on. Messages not handled by any listener are given to a default listener, which can, e.g., write an error to a debug log.

12.4 Designated Frame Types

Table 12.1 lists the frame types defined by GEX. It is divided into four logical sections: General, Bulk Read/Write, Unit Access, and Settings. The payloads belonging to those frame types will be outlined in the following sections.

Table 12.1: Frame types used by GEX

Frame type	Function	Note
0x00	Success	<i>Payload depends on context</i>
0x01	Ping	<i>GEX responds with Success and its version string</i>
0x02	Error	<i>Payload contains the error message</i>
0x03	Bulk Read Offer	<i>An offer of data to read using 0x04</i>
0x04	Bulk Read Poll	<i>Requesting to read a block of data</i>
0x05	Bulk Write Offer	<i>An offer to receive a bulk write transaction</i>
0x06	Bulk Data	<i>Used for both reading and writing</i>
0x07	Bulk End	<i>Marks the last “Bulk Data” frame</i>
0x08	Bulk Abort	
0x10	Unit Request	<i>Request to a unit</i>
0x11	Unit Report	<i>Spontaneous event generated by a unit</i>
0x20	List Units	<i>Read a list of all instantiated units</i>
0x21	INI Read	<i>Request a bulk read transaction of an INI file</i>
0x22	INI Write	<i>Request a bulk write transaction of an INI file</i>
0x23	Persist Config	<i>Write updated configuration to flash</i>

12.5 Bulk Read and Write Transactions

The bulk read and write transactions are generic, multi-message exchanges which are used to transfer the INI configuration files. They could additionally be used by some future unit requiring to transfer a large amount of data (e.g., to read image data from a camera).

The reason for splitting a long file into multiple messages, rather than sending it all in one, lies in the hardware limitations of the platform, specifically its small amount of **RAM** (the STM32F072 has only 16 kB). A message cannot be processed until its payload checksum is received and verified; however, the configuration file can have several kilobytes, owing to the numerous explanatory comments, which would require a prohibitively large data buffer. The chunked transaction could, additionally, be extended to support message re-transmission on timeout without sending the entire file again.

A read or write transaction can be aborted by a frame 0x08 (Bulk Abort) at any time, though aborting a write transaction may leave the configuration in a corrupted state. As hinted in the introduction of this chapter, a transaction is defined by sharing a common frame ID. Thus, all frames in a bulk transaction must have the same ID, otherwise the ID listeners would not be called for the subsequent messages.

Figure 12.2 shows a diagram of the bulk read and write data flow.

■ 12.5.1 Bulk Read

To read an INI file, we first send a frame 0x21 (INI Read), specifying the target file in the payload:

<i>Frame 0x21 (INI Read) payload structure</i>
<ul style="list-style-type: none"> • u8 which file to write <ul style="list-style-type: none"> – 0 ... UNITS.INI – 1 ... SYSTEM.INI

What follows is a standard bulk read transaction with the requested file. GEX offers the file for reading with a frame 0x03 (Bulk Read Offer):

<i>Frame 0x03 (Bulk Read Offer) payload structure</i>
<ul style="list-style-type: none"> • u32 full size of the file in bytes • u32 largest chunk that can be read at once

Now we can proceed to read the file using 0x04 (Bulk Read Poll), which is always responded to with 0x06 (Bulk Data), or 0x07 (Bulk End) if this was the last frame. Data frames have only the useful data as their payload. The 0x04 (Bulk Read Poll) payload specifies how many bytes we want to read:

<i>Frame 0x04 (Bulk Read Poll) payload structure</i>
<ul style="list-style-type: none"> • u32 how many bytes to read (at most)

<i>Frame 0x06 (Bulk Data) or 0x07 (Bulk End) payload in a “read” transaction</i>
<ul style="list-style-type: none"> • char [] a chunk of the read file

■ 12.5.2 Bulk Write

To overwrite an INI file, we first send a frame 0x22 (INI Write) with the file size as its payload. The name of the file is irrelevant, as it is detected automatically by inspecting the content.

<i>Frame 0x22 (INI Write) payload structure</i>
<ul style="list-style-type: none"> • u32 size of the written file, in bytes

The write request is confirmed by a frame 0x05 (Bulk Write Offer) sent back:

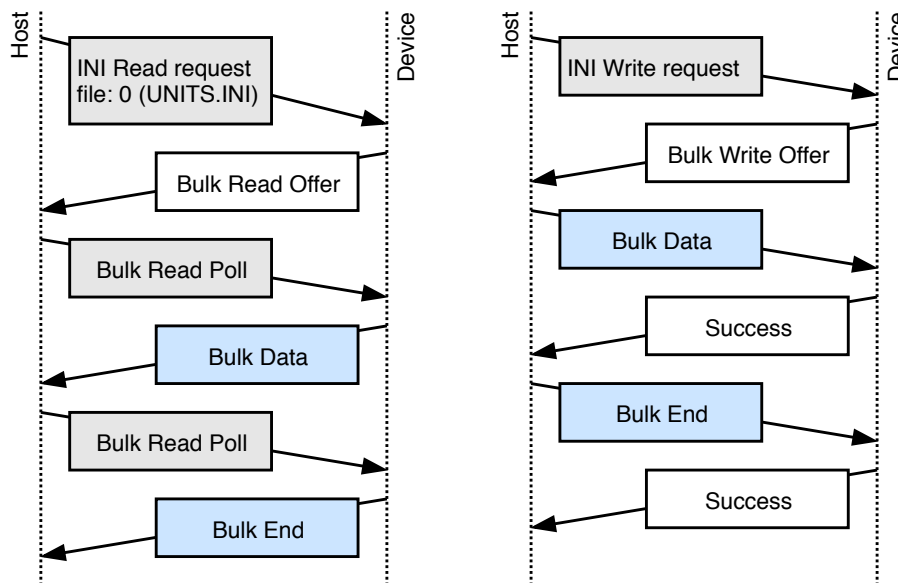

Figure 12.2: The bulk read and write transactions

Frame 0x05 (Bulk Write Offer) payload structure

- `u32` total bytes to write (here copied from the request frame)
- `u32` how many bytes may be written per message

We can now send the file as a series of frames of type 0x06 (Bulk Data), or 0x07 (Bulk End) in the last frame, with chunks of the data as their payloads. Each frame is confirmed by 0x00 (Success).

Frame 0x06 (Bulk Data) or 0x07 (Bulk End) payload in a “write” transaction

- `char[]` a chunk of the written file

12.5.3 Persisting the Changed Configuration to Flash

The written INI file is immediately parsed and the settings are applied. However, these changes are not persistent: they exist only in **RAM** and will be lost when the module restarts. To save the current state to Flash, issue a frame 0x23 (Persist Config). This has the same effect as closing the virtual mass storage by pushing the Lock button.

12.6 Reading the List of Units

The frame 0x20 (List Units) requests a list of all available units in the GEX module. The list includes all units' callsigns, names and types. The response payload has the following format:

Frame 0x20 (List Units) response structure

- **u8** the number of available units
- For each unit:
 - **u8** unit callsign
 - **cstring** unit name
 - **cstring** unit type

12.7 Unit Requests and Reports

Frame types 0x10 (Unit Request) and 0x11 (Unit Report) are dedicated to messages sent to and by unit instances. Each has a fixed header (*inside the payload*) followed by unit-specific data.

12.7.1 Unit Requests

Unit requests deliver a message from the host to a unit instance. Unit drivers implements different commands, each with its own payload structure. The frame 0x10 (Unit Request) has the following structure:

Frame 0x10 (Unit Request) payload structure

- **u8** unit callsign
- **u8** command number, handled by the unit driver
- **u8[]** command payload, handled by the unit driver; its size and content depend on the unit driver and the particular command number, as defined in [Chapter 13](#)

The most significant bit of the command byte (0x80) has a special meaning: when set, the message delivering routine responds with 0x00 (Success) after the command completes, unless an error occurred. That is used to get a confirmation that the message was delivered and the module operates correctly (as opposed to, e.g., a lock-up resulting in a watchdog reset). Requests which normally generate a response (e.g., reading a value from the unit) should not be sent with this flag, as that would produce two responses at once.

12.7.2 Unit Reports

Several unit types can produce asynchronous events, such as reporting a pin change, or a triggering condition. The event is timestamped and sent with a frame type 0x11 (Unit Report):

Frame 0x11 (Unit Report) payload structure

- **u8** unit callsign
- **u8** report type, defined by the unit driver
- **u64** event time (microseconds since power-on)
- **u8[]** report payload; similar to requests, the payload structure depends on the unit driver and the particular report type, as defined in **Chapter 13**

Chapter 13

Units Overview, Commands and Events Description

This chapter describes all functional blocks (units) implemented in GEX, version 1.0. The term “unit” will be used here to refer to both unit types (drivers) or their instances where the distinction is not important.

Each unit’s description will be accompanied by a corresponding snippet from the configuration file, and a list of supported commands and events. The commands and events described here form the payload of TinyFrame messages 0x10 (Unit Request) and 0x11 (Unit Report), as described in [Section 12.7](#).

The number in the first column of the command (or event) tables, marked as “Code”, is the command number (or report type) used in the payload to identify how the message data should be treated. When the request or response payload is empty, it is omitted from the table. The same applies to commands with no response, in which case adding 0x80 to the command number triggers a type 0x00 (Success) response after the command is finished.

13.1 General Notes

13.1.1 Unit Naming

Unit types are named in uppercase (SPI, 1WIRE, NPX) in the INI file and in the list of units. Unit instances can be named in any way the user desires; using lowercase makes it easier to distinguish them from unit types. It is advisable to use descriptive names, e.g., not “pin1”, but rather “button”.

13.1.2 Packed Pin Access

Several units facilitate an access to a group of GPIO pins, such as the digital input and output units, or the SPI unit’s slave select pins. The STM32 microcontroller’s ports have 16 pins each, most of which can be configured to one of several alternative functions (e.g., SPI, PWM outputs, ADC input). As a consequence, it is common to be left with a discontinuous group of pins after assigning all the alternative functions needed by an application.

For instance, we could only have the pins 0, 1, 12–15 available on a **GPIO** port. GEX provides a helpful abstraction to bridge the gaps in the port: The selected pins are packed together and represented, in commands and events, as a block of six pins (0x3F) instead of

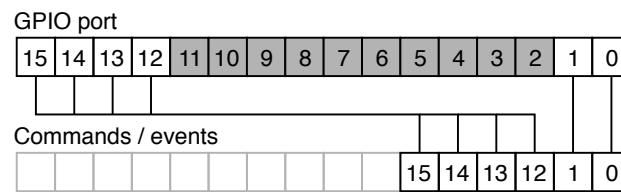

Figure 13.1: Pin packing

their original positions in the register (0xF003). This scheme is shown in [Figure 13.1](#). The translation is done in the unit driver and works transparently, as if the block of pins had no gaps—all the referenced pins are updated simultaneously without glitches. Where pin numbers are used, the order in the packed word should be provided—in our example, that would be 0–5, counting from the least significant bit.

13.2 Digital Output

The digital output unit provides a write access to one or more pins of a **GPIO** port. This unit additionally supports pulse generation on any of its pins; this is implemented in software, with timing derived from the system timebase, in order to support pulses on all pins regardless of hardware **PWM** support. Pins in commands are expressed in the packed format ([Section 13.1.2](#)).

13.2.1 Digital Output Configuration

```
[D0:out01]
# Port name
port=A
# Pins (comma separated, supports ranges)
pins=0
# Initially high pins
initial=
# Open-drain pins
open-drain=
```

13.2.2 Digital Output Commands

Code	Function	Structure
0	WRITE Write to all pins	<i>Request:</i> <ul style="list-style-type: none"> • u16 new value
1	SET Set selected pins to 1	<i>Request:</i> <ul style="list-style-type: none"> • u16 pins to set

Code	Function	Structure
2	CLEAR Set selected pins to 0	<i>Request:</i> <ul style="list-style-type: none"> • u16 pins to clear
3	TOGGLE Toggle selected pins	<i>Request:</i> <ul style="list-style-type: none"> • u16 pins to toggle
4	PULSE Generate a pulse on the selected pins. The microsecond scale may be used only for 0–999 μ s.	<i>Request:</i> <ul style="list-style-type: none"> • u16 pins to pulse • bool active level • u8 scale: 0–ms, 1–μs • u16 duration

13.3 Digital Input

The digital input unit is the input counterpart of the digital output unit. In addition to reading the immediate digital levels of the selected pins, this unit can report asynchronous events on a pin change.

All pins of the unit may be configured either for a rising, falling, or for any change detection; due to a hardware limitation, the same pin number may not be used for event detection on different ports (e.g., A1 and B1) at the same time. In order to receive a pin change event, we must first arm the pin using a command; it can be armed for a single event, or it may be re-armed automatically with a hold-off time. It is further possible to automatically arm selected pins on start-up, removing the need to arm them, e.g., after the module restarts or is re-connected.

13.3.1 Digital Input Configuration

```
[DI:in@2]
# Port name
port=A
# Pins (comma separated, supports ranges)
pins=10-8,3-0
# Pins with pull-up
pull-up=10,9
# Pins with pull-down
pull-down=0

# Trigger pins activated by rising/falling edge
trig-rise=10
trig-fall=
# Trigger pins auto-armed by default
auto-trigger=10
```

```
# Triggers hold-off time (ms)
hold-off=100
```

13.3.2 Digital Input Events

Code	Function	Structure
0	PIN_CHANGE A pin change event. The payload includes a snapshot of all configured pins captured immediately after the change was registered.	<i>Payload:</i> <ul style="list-style-type: none"> • u16 changed pins • u16 port snapshot

13.3.3 Digital Input Commands

Code	Function	Structure
0	READ Read the pins	<i>Response:</i> <ul style="list-style-type: none"> • u16 pin states
1	ARM_SINGLE Arm for a single event	<i>Request:</i> <ul style="list-style-type: none"> • u16 pins to arm
2	ARM_AUTO Arm with automatic re-arming after each event	<i>Request:</i> <ul style="list-style-type: none"> • u16 pins to arm
3	DISARM Dis-arm selected pins	<i>Request:</i> <ul style="list-style-type: none"> • u16 pins to dis-arm

13.4 SIPO (Shift Register) Unit

The shift registers driver unit is designed for the loading of data into **serial in, parallel out (SIPO)** shift registers, such as 74xx4094 or 74xx595. These are commonly used to control segmented **LED** displays, **LED** user interfaces, etc.

A SIPO shift register has the following digital pins:

- *Shift* – **SCK**; shifts the data in the register by one bit
- *Data In* – **MOSI**; serial data to load into the register
- *Data Out* – output for daisy-chaining with other shift registers
- *Store* – latches the current register data and shows it at the outputs
- *Clear* – erases the latched data and clears the display

This unit automatically handles both the *Shift* and *Store* signals, provides access to the *Clear* output, and is capable of loading multiple shift registers in parallel (an arrangement sometimes used instead of daisy-chaining). The polarity (active level) of all signals can be configured.

It is, additionally, possible to set the data lines to arbitrary “idle” level(s) before sending the *Store* pulse; this may be latched and used for some additional feature on the user interface, such as a brightness control.

13.4.1 SIPO Configuration

```
[SIPO:display@9]
# Shift pin & its active edge (1-rising,0-falling)
shift-pin=A1
shift-pol=1
# Store pin & its active edge
store-pin=A0
store-pol=1
# Clear pin & its active level
clear-pin=A2
clear-pol=0
# Data port and pins
data-port=A
data-pins=3
```

13.4.2 SIPO Commands

The WRITE and CLEAR_DIRECT commands are the only ones normally used. The others provide manual control over all the output signals for debugging or testing.

Code	Function	Structure
0	WRITE Load the shift registers and leave the <i>Data</i> outputs in the “trailing data” state before sending a <i>Store</i> pulse.	<i>Request:</i> <ul style="list-style-type: none"> • u16 trailing data (packed pins) • For each output (same size) <ul style="list-style-type: none"> – u8[] data to load
1	DIRECT_DATA Directly write to the <i>Data</i> pin(s)	<i>Request:</i> <ul style="list-style-type: none"> • u16 values to write (packed pins)
2	DIRECT_CLEAR Pulse the <i>Clear</i> pin	
3	DIRECT_SHIFT Pulse the <i>Shift</i> pin	

Code	Function	Structure
4	DIRECT_STORE Pulse the <i>Store</i> pin	

13.5 NeoPixel Unit

The NeoPixel unit implements the protocol needed to control a digital **LED** strip with WS2812, WS2811, or compatible **LED** driver chips. The NeoPixel protocol (explained in [Section 7.5](#)) is implemented in software, therefore it is available on any **GPIO** pin of the module.

The color data can be loaded in five different formats: as packed bytes (3×8 bits color), or as the little- or big-endian encoding of colors in a 32-bit format: 0x00RRGGBB or 0x00BBGRR. The 32-bit format is convenient when the colors are already represented as an array of 32-bit integers, e.g., extracted from a screen capture or an image.

13.5.1 NeoPixel Configuration

```
[NPX:neo03]
# Data pin
pin=A0
# Number of pixels
pixels=32
```

13.5.2 NeoPixel Commands

Code	Function	Structure
0	CLEAR Switch all LEDs off (sets them to black)	
1	LOAD Load a sequence of R,G,B bytes	<i>Request:</i> <ul style="list-style-type: none"> • For each LEDs: <ul style="list-style-type: none"> – u8 red – u8 green – u8 blue
4	LOAD_U32_ZRGB Load 32-bit big-endian 0xRRGGBB (0,R,G,B)	<i>Request:</i> <ul style="list-style-type: none"> • u32[] color data (big-endian)

Code	Function	Structure
5	LOAD_U32_ZBGR Load 32-bit big-endian 0xBBGGRR (0,B,G,R)	<i>Request:</i> • u32[] color data (big-endian)
6	LOAD_U32_RGBZ Load 32-bit little-endian 0xBBGGRR (R,G,B,0)	<i>Request:</i> • u32[] color data (little-endian)
7	LOAD_U32_BGRZ Load 32-bit little-endian 0xRRGGBB (B,G,R,0)	<i>Request:</i> • u32[] color data (little-endian)
10	GET_LEN Get number of LEDs in the strip	<i>Response:</i> • u16 number of LEDs

13.6 SPI Unit

The **SPI** unit provides access to one of the microcontroller's **SPI** peripherals. The unit can be configured to any of the hardware-supported speeds, clock polarity, and clock phase settings. Explanation of those options, including diagrams, can be found in [Section 7.2](#).

The unit handles up to 16 slave select (**NSS**) signals and supports message multi-cast (addressing more than one slaves at once). Protection resistors should be used if a multi-cast transaction is issued with **MISO** connected to prevent a short circuit between slaves transmitting the opposite logical level.

The **QUERY** command of this unit, illustrated by [Figure 13.2](#), is flexible enough to support all types of **SPI** transactions: read-only, write-only, and read-write, with different request and response lengths and paddings. The slave select signal is asserted during the entire transaction.

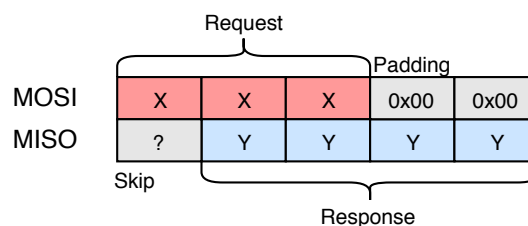

Figure 13.2: SPI transaction using the **QUERY** command

13.6.1 SPI Configuration

```
[SPI:spi@5]
# Peripheral number (SPIx)
device=1
```

```

# Pin mappings (SCK,MISO,MOSI)
# SPI1: (0) A5,A6,A7      (1) B3,B4,B5
# SPI2: (0) B13,B14,B15
remap=0
# Prescaler: 2,4,8,...,256
prescaler=64
# Clock polarity: 0,1 (clock idle level)
cpol=0
# Clock phase: 0,1 (active edge, 0-first, 1-second)
cpa=0
# Transmit only, disable MISO
tx-only=N
# Bit order (LSB or MSB first)
first-bit=MSB
# SS port name
port=A
# SS pins (comma separated, supports ranges)
pins=0

```

13.6.2 SPI Commands

Code	Function	Structure
0	QUERY Exchange bytes with a slave device; see the diagram in Figure 13.2	<i>Request:</i> <ul style="list-style-type: none"> • u8 slave number 0–16 • u16 response padding • u16 response length • u8 [] bytes to write <i>Response:</i> <ul style="list-style-type: none"> • u8 [] received bytes
1	MULTICAST Send a message to multiple slaves at once. The “addressed slaves” word uses the packed pins format (Section 13.1.2).	<i>Request:</i> <ul style="list-style-type: none"> • u16 addressed slaves • u8 [] bytes to write

13.7 I²C Unit

The I²C unit provides access to one of the microcontroller’s I²C peripherals. More on the I²C bus can be found in [Section 7.3](#).

The unit can be configured to use either of the three standard speeds (Standard, Fast and Fast+) and supports both 10-bit and 7-bit addressing. 10-bit addresses can be used in commands by setting their highest bit (0x8000), as a flag to the unit; the 7 or 10 least significant bits will be used as the actual address.

13.7.1 I²C Configuration

```
[I2C:i2c@4]
# Peripheral number (I2Cx)
device=1
# Pin mappings (SCL,SDA)
# I2C1: (0) B6,B7 (1) B8,B9
# I2C2: (0) B10,B11 (1) B13,B14
remap=0

# Speed: 1-Standard, 2-Fast, 3-Fast+
speed=1
# Analog noise filter enable (Y,N)
analog-filter=Y
# Digital noise filter bandwidth (0-15)
digital-filter=0
```

13.7.2 I²C Commands

Code	Function	Structure
0	WRITE Perform a raw write transaction	<i>Request:</i> <ul style="list-style-type: none"> • u16 slave address • u8[] bytes to write
1	READ Perform a raw read transaction.	<i>Request:</i> <ul style="list-style-type: none"> • u16 slave address • u16 number of read bytes <i>Response:</i> <ul style="list-style-type: none"> • u8[] received bytes
2	WRITE_REG Write to a slave register. Sends the register number and the data in the same transaction. Multiple registers can be written at once if the slave supports auto-increment.	<i>Request:</i> <ul style="list-style-type: none"> • u16 slave address • u8 register number • u8[] bytes to write
3	READ_REG Read from a slave register. Writes the register number and issues a read transaction of the given length. Multiple registers can be read at once if the slave supports auto-increment.	<i>Request:</i> <ul style="list-style-type: none"> • u16 slave address • u8 register number • u16 number of read bytes <i>Response:</i> <ul style="list-style-type: none"> • u8[] received bytes

13.8 USART Unit

The **USART** unit provides access to one of the microcontroller's **USART** peripherals. See [Section 7.1](#) for more information about the interface.

Most **USART** parameters available in the hardware peripheral's configuration registers can be adjusted to match the application's needs. The peripheral is capable of driving RS-485 transceivers, using the **Driver Enable (DE)** output for switching between reception and transmission.

The unit implements asynchronous reception and transmission with **DMA** and a circular buffer ([Figure 13.3](#)). Received data is sent to the host in asynchronous events when a half of the buffer is filled, or after a fixed timeout from the last received byte. The write access is, likewise, implemented using a **DMA** buffer.

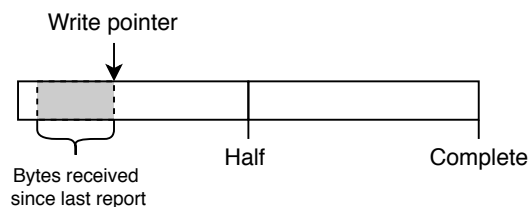

Figure 13.3: Principle of DMA-based UART reception. Interrupt is generated in the half and at the end of the buffer, at which point the write pointer wraps back to the beginning.

13.8.1 USART Configuration

```
[USART:ser@6]
# Peripheral number (UARTx 1-4)
device=1
# Pin mappings (TX,RX,CK,CTS,RTS/DE)
# USART1: (0) A9,A10,A8,A11,A12 (1) B6,B7,A8,A11,A12
# USART2: (0) A2,A3,A4,A0,A1 (1) A14,A15,A4,A0,A1
# USART3: (0) B10,B11,B12,B13,B14
# USART4: (0) A0,A1,C12,B7,A15 (1) C10,C11,C12,B7,A15
remap=0

# Baud rate in bps (eg. 9600)
baud-rate=115200
# Parity type (NONE, ODD, EVEN)
parity=NONE
# Number of stop bits (0.5, 1, 1.5, 2)
stop-bits=1
# Bit order (LSB or MSB first)
first-bit=LSB
# Word width (7,8,9) - including parity bit if used
word-width=8
```

```

# Enabled lines (RX,TX,RXTX)
direction=RXTX
# Hardware flow control (NONE, RTS, CTS, FULL)
hw-flow-control=NONE

# Generate serial clock (Y,N)
clock-output=N
# Clock polarity: 0,1
cpol=0
# Clock phase: 0,1
cpha=0

# Generate RS485 Driver Enable signal (Y,N) - uses RTS pin
de-output=N
# DE active level: 0,1
de-polarity=1
# DE assert time (0-31)
de-assert-time=8
# DE clear time (0-31)
de-clear-time=8

```

13.8.2 USART Events

Code	Function	Structure
0	DATA_RECEIVED Data was received on the serial port.	<i>Payload:</i> <ul style="list-style-type: none"> • <code>u8[]</code> received bytes

13.8.3 USART Commands

Code	Function	Structure
0	WRITE Add data to the transmit buffer. Sending is asynchronous, but the command may wait for free space in the DMA buffer.	<i>Request:</i> <ul style="list-style-type: none"> • <code>u8[]</code> bytes to write
1	WRITE_SYNC Add data to the transmit buffer and wait for the transmission to complete.	<i>Request:</i> <ul style="list-style-type: none"> • <code>u8[]</code> bytes to write

13.9 1-Wire Unit

The 1-Wire unit implements the Dallas Semiconductor's 1-Wire protocol, most commonly used to interface smart thermometers (DS18x20). The protocol is explained in [Section 7.4](#).

This unit implements the ROM Search algorithm that is used to find the ROM codes of all 1-Wire devices connected to the bus. The algorithm can find up to 32 devices in one run; more devices can be found by issuing the `SEARCH_CONTINUE` command.

Devices are addressed using their ROM codes, unique 64-bit (8-byte) identifiers that work as addresses. When only one device is connected, the value 0 may be used instead and the addressing will be skipped. Its ROM code may be recovered using the `READ_ADDR` command or by the search algorithm.

13.9.1 1-Wire Configuration

```
[1WIRE:ow@7]
# Data pin
pin=A0
# Parasitic (bus-powered) mode
parasitic=N
```

13.9.2 1-Wire Commands

Code	Function	Structure
0	CHECK_PRESENCE Test if there are any devices attached to the bus.	<i>Response:</i> <ul style="list-style-type: none"> <code>bool</code> presence detected
1	SEARCH_ADDR Start the search algorithm.	<i>Response:</i> <ul style="list-style-type: none"> <code>bool</code> should continue <code>u64 []</code> ROM codes
2	SEARCH_ALARM Start the search algorithm, finding only devices in an alarm state.	<i>Response:</i> <ul style="list-style-type: none"> <code>bool</code> should continue <code>u64 []</code> ROM codes
3	SEARCH_CONTINUE Continue a previously started search	<i>Response:</i> <ul style="list-style-type: none"> <code>bool</code> should continue <code>u64 []</code> ROM codes
4	READ_ADDR Read a device address (single device only)	<i>Response:</i> <ul style="list-style-type: none"> <code>u64</code> ROM code

Code	Function	Structure
10	WRITE Write bytes to a device.	<i>Request:</i> <ul style="list-style-type: none"> • u64 ROM code • u8[] bytes to write
11	READ Write a request and read response.	<i>Request:</i> <ul style="list-style-type: none"> • u64 ROM code • u16 read length • bool verify checksum • u8[] request bytes <i>Response:</i> <ul style="list-style-type: none"> • u8[] read bytes
20	POLL_FOR_1 Wait for a READY status, used by DS18x20. Not available in parasitic mode. Responds with SUCCESS after all devices are ready.	

13.10 Frequency Capture Unit

The frequency capture unit implements both the frequency measurement methods explained in [Section 8.1](#): direct and reciprocal.

The unit has several operational modes: idle, reciprocal continuous, reciprocal burst, direct continuous, direct burst, free counting, and single pulse. Burst mode is an on-demand measurement with optional averaging. Continuous mode does not support averaging, but the latest measurement can be read at any time without a delay.

13.10.1 Value Conversion Formulas

Several of the features implemented in this unit would require floating point arithmetic to provide the measured value in the desired units (Hz, seconds). That is not available in Arm Cortex-M, only as a software implementation. The calculation is left to the client in order to save Flash space that would be otherwise used by the arithmetic functions. This arrangement also avoids rounding errors and a possible loss of precision.

Reciprocal (Indirect) Measurement

Period (in seconds) is computed as:

$$T = \frac{\text{period_sum}}{f_{\text{core,MHz}} \cdot 10^6 \cdot n_{\text{periods}}} \quad (13.1)$$

The frequency is obtained by simply inverting it:

$$f = T^{-1} \quad (13.2)$$

The average duty cycle is computed as the ratio of the sum of active-level pulses and the sum of all periods:

$$\text{average_duty} = \frac{\text{ontime_sum}}{\text{period_sum}} \quad (13.3)$$

■ Direct Measurement

The frequency can be derived from the pulse count and measurement time using its definition (t_{ms} is measurement time in milliseconds):

$$f = \frac{1000 \cdot \text{count} \cdot \text{prescaller}}{t_{\text{ms}}} \quad (13.4)$$

■ 13.10.2 Frequency Capture Configuration

```
[FCAP:j@10]
# Signal input pin - one of:
# Full support: A0, A5, A15
# Indirect only: A1, B3
pin=A0

# Active level or edge (0-low,falling; 1-high,rising)
active-level=1
# Input filtering (0-15)
input-filter=0
# Pulse counter pre-divider (1,2,4,8)
direct-presc=1
# Pulse counting interval (ms)
direct-time=1000

# Mode on startup: N-none, I-indirect, D-direct, F-free count
initial-mode=N
```

■ 13.10.3 Frequency Capture Commands

Some commands include optional parameter setting. Using 0 in the field keeps the previous value. Those fields are marked with *.

Code	Function	Structure
0	STOP Stop all measurements, go idle	
1	INDIRECT_CONT_START Start a repeated reciprocal measurement	
2	INDIRECT_BUTST_START Start a burst of reciprocal measurements	<i>Request:</i> <ul style="list-style-type: none"> • u16 number of periods <i>Response:</i> <ul style="list-style-type: none"> • u16 core speed (MHz) • u16 number of periods • u64 sum of all periods (ticks) • u16 sum of on-times (ticks)
3	DIRECT_CONT_START Start a repeated direct measurement	<i>Request:</i> <ul style="list-style-type: none"> • u16 *measurement time • u8 *prescaller (1, 2, 4, 8)
4	DIRECT_BURST_START Start a single direct measurement. Longer capture time may help increase accuracy for stable signals.	<i>Request:</i> <ul style="list-style-type: none"> • u16 *measurement time (ms) • u8 *prescaller (1, 2, 4, 8) <i>Response:</i> <ul style="list-style-type: none"> • u8 prescaller • u16 measurement time (ms) • u32 pulse count
5	FREECOUNT_START Clear and start the pulse counter	<i>Request:</i> <ul style="list-style-type: none"> • u8 *prescaller (1, 2, 4, 8)
6	MEASURE_SINGLE_PULSE Measure a single pulse of the active level. Waits for a rising edge.	<i>Response:</i> <ul style="list-style-type: none"> • u16 core speed (MHz) • u32 pulse length (ticks)
7	FREECOUNT_CLEAR Read and clear the pulse counter.	<i>Response:</i> <ul style="list-style-type: none"> • u32 previous counter value
10	INDIRECT_CONT_READ Read the latest value from the continuous reciprocal measurement, if running.	<i>Response:</i> <ul style="list-style-type: none"> • u16 core speed (MHz) • u32 period length (ticks) • u32 on-time (ticks)
11	DIRECT_CONT_READ Read the latest value from the continuous direct measurement, if running.	<i>Response:</i> <ul style="list-style-type: none"> • u8 prescaller • u16 measurement time (ms) • u32 pulse count

Code	Function	Structure
12	FREECOUNT_READ Read the pulse counter value	<i>Response:</i> • u32 pulse count
20	SET_POLARITY Set pulse polarity (active level)	<i>Response:</i> • bool polarity
21	SET_PRESCALLER Set prescaller for the direct mode	<i>Response:</i> • u8 prescaller (1, 2, 4, 8)
22	SET_INPUT_FILTER Set input filtering (a hardware feature designed to ignore glitches)	<i>Response:</i> • u8 filtering factor (0–15, 0=off)
23	SET_DIR_MSEC Set direct measurement time	<i>Response:</i> • u16 measurement time (ms)
30	RESTORE_DEFAULTS Restore all run-time adjustable parameters to their configured default values	

13.11 ADC Unit

The analog/digital converter unit is one of the most complicated and powerful units implemented in the project.

The unit can measure the voltage on an input pin, either as its immediate value, or averaged with exponential forgetting. The smoothing formula is (y —averaged output, t —sample number, k —smoothing factor, u —raw measured value):

$$y[t] = (1 - k) \cdot y[t - 1] + k \cdot u[t] \quad (13.5)$$

Isochronous sampling is available as well: it is possible to capture a fixed-length block of data on demand, or as a response to a triggering condition on any of the enabled input pins. The **ADC** must continuously sample the inputs to make the averaging and level based triggering possible, which is implemented using **DMA**; as a consequence, a pre-trigger buffer is available that can be read together with the block of samples following a trigger (Figure 13.4). The **ADC** unit can also be switched to a continuous streaming mode, a block capture which continues indefinitely, until the host decides to stop the stream.

It is possible to activate any number of the 16 analog inputs of the **ADC** peripheral simultaneously, together with the internal input channels. The maximum continuous sampling frequency, which reaches 70 ksp/s with one channel, lowers with an increasing number of enabled channels, as the amount of data to transfer host increases. Those high speeds are achievable in shorter block captures, taking advantage of the (configurable) data buffer. An ongoing capture may be terminated by the unit after the buffer is exhausted.

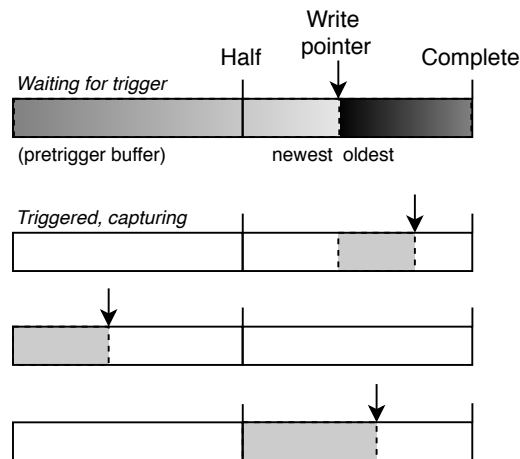

Figure 13.4: Principle of DMA-based ADC sampling. The buffer is continually filled with new samples; when the triggering condition is hit, the historical records from the buffer are sent as a pre-trigger buffer, and a block capture begins. The following samples are sent to the host when either half of the buffer is filled, or the required number of samples have been sent. The sampling never stops, ensuring a pre-trigger buffer is always ready.

13.11.1 ADC Configuration

```
[ADC:adc@8]
# Enabled channels, comma separated
# 0 1 2 3 4 5 6 7 8 9 10 11 12 13 14 15 16 17
# A0 A1 A2 A3 A4 A5 A6 A7 B0 B1 C0 C1 C2 C3 C4 C5 Tsens Vref
channels=16

# Sampling time (0-7)
sample_time=2
# Sampling frequency (Hz)
frequency=1000

# Sample buffer size
# - shared by all enabled channels
# - defines the maximum pre-trigger size (divide by # of channels)
# - captured data is sent in half-buffer chunks
# - buffer overrun aborts the data capture
buffer_size=256

# Enable continuous sampling with averaging
# Caution: This can cause DAC output glitches
averaging=Y
# Exponential averaging coefficient (permil, range 0-1000 ~ 0.000-1.000)
# - used formula:  $y[t]=(1-k)*y[t-1]+k*u[t]$ 
# - not available when a capture is running
avg_factor=500
```

13.11.2 ADC Events

Code	Function	Structure
50	TRIGGERED The first event generated when a triggering condition occurs. The payload includes pre-trigger and the transaction continues with a sequence of CAPTURE events sharing the same frame ID. The serial number is incremented with each stream chunk and can be used to detect lost data frames.	<i>Payload:</i> <ul style="list-style-type: none"> • u32 pre-trigger length • u8 triggering edge (1–falling, 2–rising, 3–forced) • u8 stream serial number • u16 [] pre-trigger data
51	CAPTURE_DATA A chunk of sampled data in a stream, block, or a triggered capture. More data will follow.	<i>Payload:</i> <ul style="list-style-type: none"> • u8 stream serial number • u16 [] sample data
52	CAPTURE_END Indicates the end of a multi-part capture. The payload may be empty if there is no more data to send (e.g., a stream had to be unexpectedly closed).	<i>Payload:</i> <ul style="list-style-type: none"> • u8 stream serial number • u16 [] sample data

13.11.3 ADC Commands

Code	Function	Structure
0	READ_RAW Get the last raw sample from enabled channels.	<i>Response:</i> <ul style="list-style-type: none"> • u16 [] raw values 0–4095
1	READ_SMOOTHED Get the averaged values from enabled channels. Not available for high sample rates and when disabled.	<i>Response:</i> <ul style="list-style-type: none"> • float [] smoothed values 0–4095
2	READ_CAL_CONSTANTS Read factory calibration constants from the MCU's ROM. These are used to calculate real voltage or temperature from the ADC output word. The formulas can be found in Section 13.9 of the STM32F0 reference manual [42].	<i>Response:</i> <ul style="list-style-type: none"> • u16 VREFINT_CAL (word) • u16 VREFINT_CAL_VDD (mV) • u16 TS_CAL1 (word) • u16 TS_CAL2 (word) • u16 TS_CAL1_T (°C) • u16 TS_CAL2_T (°C) • u16 TS_CAL_VDD (mV)

Code	Function	Structure
10	GET_ENABLED_CHANNELS Get numbers of all enabled channels (0-based)	<i>Response:</i> <ul style="list-style-type: none"> • u8[] enabled channel numbers
11	GET_SAMPLE_RATE Get the current sample rate (in Hz)	<i>Response:</i> <ul style="list-style-type: none"> • u32 requested sample rate • float achieved sample rate
20	SETUP_TRIGGER Configure the triggering level and other trigger parameters. This command does <i>not</i> arm the trigger.	<i>Request:</i> <ul style="list-style-type: none"> • u8 source channel number • u16 triggering level • u8 active edge (1–falling, 2–rising, 3–any) • u32 pre-trigger sample count • u32 post-trigger sample count • u16 hold-off time (ms) • bool auto re-arm
21	ARM Arm the trigger for capture.	<i>Request:</i> <ul style="list-style-type: none"> • u8 auto re-arm (0, 1, 255–no change)
22	DISARM Dis-arm the trigger.	
23	ABORT Abort any ongoing capture and dis-arm the trigger.	
24	FORCE_TRIGGER Manually trip the trigger, as if the threshold level was reached.	
25	BLOCK_CAPTURE Capture a fixed-length sequence of samples.	<i>Request:</i> <ul style="list-style-type: none"> • u32 number of samples
26	STREAM_START Start a continuous stream of samples	
27	STREAM_STOP Stop an ongoing stream	
28	SET_SMOOTHING_FACTOR Set the smoothing factor ($\times 10^3$). 1000 corresponds to $k = 1$.	<i>Request:</i> <ul style="list-style-type: none"> • u16 smoothing factor 0–1000
29	SET_SAMPLE_RATE Set the sampling frequency.	<i>Request:</i> <ul style="list-style-type: none"> • u32 frequency in Hz

Code	Function	Structure
30	ENABLE_CHANNELS Select channels to sample. The channels must be configured in the unit settings.	<i>Request:</i> • u32 bit map of channels to enable
31	SET_SAMPLE_TIME Set the sample time of the ADC's sample&hold circuit.	<i>Request:</i> • u8 sample time 0–7

13.12 DAC Unit

The digital/analog unit works with the two-channel DAC hardware peripheral. It can be used in two modes: DC output, and waveform generation.

The waveform mode implements direct digital synthesis (explained in Section 8.3.2) of a sine, rectangle, sawtooth or triangle wave. The generated frequency can be set with a sub-hertz precision up to the lower tens of kHz. The two outputs can use a different waveform shape, can be synchronized, and their phase offset and frequency are dynamically adjustable.

13.12.1 DAC Configuration

```
[DAC:dac@13]
# Enabled channels (1:A4, 2:A5)
ch1_enable=Y
ch2_enable=Y
# Enable output buffer
ch1_buff=Y
ch2_buff=Y
# Superimposed noise type (NONE,WHITE,TRIANGLE) and nbr. of bits (1-12)
ch1_noise=NONE
ch1_noise-level=3
ch2_noise=NONE
ch2_noise-level=3
```

13.12.2 DAC Commands

Channels are specified in all commands as a bit map:

- 0x01 – channel 1
- 0x02 – channel 2
- 0x03 – both channels affected at once

Code	Function	Structure
0	WAVE_DC Set a DC level, disable DDS for the channel	<i>Request:</i> <ul style="list-style-type: none"> • u8 channels • u16 level (0–4095)
1	WAVE_SINE Start a sine waveform	<i>Request:</i> <ul style="list-style-type: none"> • u8 channels
2	WAVE_TRIANGLE Start a symmetrical triangle waveform	<i>Request:</i> <ul style="list-style-type: none"> • u8 channels
3	WAVE_SAWTOOTH_UP Start a rising sawtooth waveform	<i>Request:</i> <ul style="list-style-type: none"> • u8 channels
4	WAVE_SAWTOOTH_DOWN Start a falling sawtooth waveform	<i>Request:</i> <ul style="list-style-type: none"> • u8 channels
5	WAVE_RECTANGLE Start a rectangle waveform	<i>Request:</i> <ul style="list-style-type: none"> • u8 channels • u16 on-time (0–8191) • u16 high level (0–4095) • u16 low level (0–4095)
10	SYNC Synchronize the two channels. The phase accumulator is reset to zero.	
20	SET_FREQUENCY Set the channel frequency	<i>Request:</i> <ul style="list-style-type: none"> • u8 channels • float frequency
21	SET_PHASE Set a channel's phase. It is recommended to only set the phase of one channel, leaving the other at 0°.	<i>Request:</i> <ul style="list-style-type: none"> • u8 channels • u16 phase (0–8191)
22	SET_DITHER Control the dithering function of the DAC block. A high noise amplitude can cause an overflow to the other end of the output range due to a bug in the DAC peripheral. Use value 255 to leave the parameter unchanged.	<i>Request:</i> <ul style="list-style-type: none"> • u8 channels • u8 noise type (0–none, 1–white, 2–triangle) • u8 number of noise bits (1–12)

13.13 PWM Unit

The **PWM** unit uses a timer/counter to generate a **PWM** (pulse train) signal. There are four outputs with a common frequency and independent duty cycles. Each channel can be individually enabled or disabled. This unit is intended for applications such as light dimming, heater regulation, or the control of H-bridges.

13.13.1 PWM Configuration

```
[PWMDIM:pwm012]
# Default pulse frequency (Hz)
frequency=1000
# Pin mapping - 0=disabled
# Channel1 - 1:PA6, 2:PB4, 3:PC6
ch1_pin=1
# Channel2 - 1:PA7, 2:PB5, 3:PC7
ch2_pin=0
# Channel3 - 1:PB0, 2:PC8
ch3_pin=0
# Channel4 - 1:PB1, 2:PC9
ch4_pin=0
```

13.13.2 PWM Commands

Code	Function	Structure
0	SET_FREQUENCY Set the PWM frequency	<i>Request:</i> <ul style="list-style-type: none"> • u32 frequency in Hz
1	SET_DUTY Set the duty cycle of one or more channels	<i>Request:</i> <ul style="list-style-type: none"> • Repeat 1–4 times: <ul style="list-style-type: none"> – u8 channel number 0–3 – u16 duty cycle 0–1000
2	STOP Stop the hardware timer. Outputs enter low level.	
3	START Start the hardware timer.	

13.14 Touch Sense Unit

The touch sensing unit provides an access to the **TSC** peripheral, explained in [Section 8.4](#). The unit configures the **TSC** and reads the output values of each enabled touch pad. Additionally, a threshold-based digital input function is implemented to make the emulation of touch buttons easier. The hysteresis and debounce time can be configured in the configuration file or set using a command. The threshold of individual pads must be set using a command.

13.14.1 Touch Sense Configuration

```
[TOUCH:touch@11]
# Pulse generator clock prescaller (1,2,4,...,128)
pg-clock-prediv=32
# Sense pad charging time (1-16)
charge-time=2
# Charge transfer time (1-16)
drain-time=2
# Measurement timeout (1-7)
sense-timeout=7

# Spread spectrum max deviation (0-128,0=off)
ss-deviation=0
# Spreading clock prescaller (1,2)
ss-clock-prediv=1

# Optimize for interlaced pads (individual sampling with others floating)
interlaced-pads=N

# Button mode debounce (ms) and release hysteresis (lsb)
btn-debounce=20
btn-hysteresis=10

# Each used group must have 1 sampling capacitor and 1-3 channels.
# Channels are numbered 1,2,3,4

# Group1 - 1:A0, 2:A1, 3:A2, 4:A3
g1_cap=
g1_ch=
# Group2 - 1:A4, 2:A5, 3:A6, 4:A7
g2_cap=
g2_ch=
# ...
```

13.14.2 Touch Sense Events

Code	Function	Structure
0	BUTTON_CHANGE The binary state of some of the capacitive pads with button mode enabled changed.	<i>Payload:</i> <ul style="list-style-type: none"> • u32 binary state of all channels • u32 changed / trigger-generating channels

13.14.3 Touch Sense Commands

Code	Function	Structure
0	READ Read the raw touch pad values (lower indicates higher capacitance). Values are ordered by group and channel.	<i>Request:</i> <ul style="list-style-type: none"> • u16 [] raw values
1	SET_BIN_THR Set the button mode thresholds for all channels. Value 0 disables the button mode for a channel.	<i>Request:</i> <ul style="list-style-type: none"> • u16 [] thresholds
2	DISABLE_ALL_REPORTS Set thresholds to 0, disabling the button mode for all pads.	
3	SET_DEBOUNCE_TIME Set the button mode debounce time (used for all pads with button mode enabled).	<i>Request:</i> <ul style="list-style-type: none"> • u16 debounce time (ms)
4	SET_HYSTERESIS Set the button mode hysteresis.	<i>Request:</i> <ul style="list-style-type: none"> • u16 hysteresis

Chapter 14

Wireless Interface

Four methods of a wireless connection have been considered: Bluetooth (perhaps with the Texas Instruments CC2541), WiFi with the Espressif ESP8266, a 868 MHz long range radio link with the Semtech SX1276, and a 2.4 GHz radio link with the nRF24L01+. Bluetooth was dismissed early for its complexity, and the ESP8266 for its high power consumption, although both solutions might be viable for certain applications and with more development time.

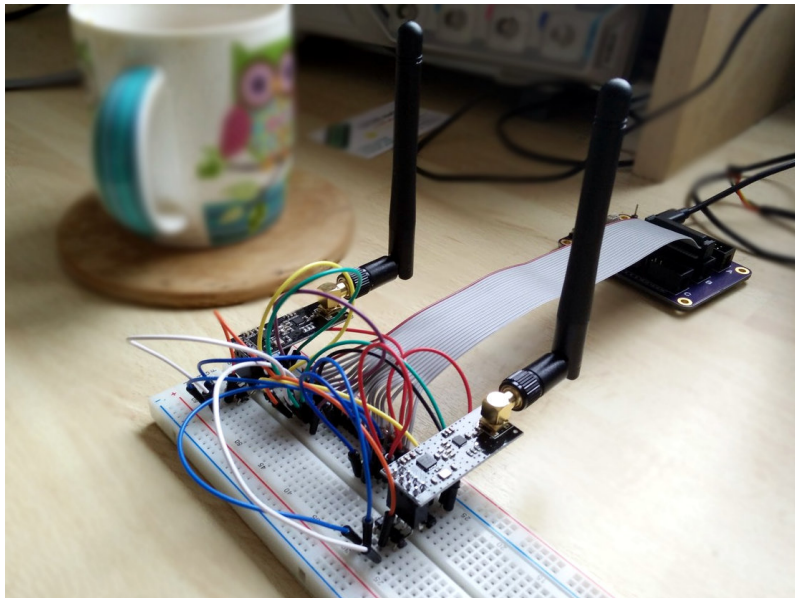

Figure 14.1: Test setup with a GEX prototype controlling two nRF24L01+ modules

14.1 Modulations Overview

A brief overview of the different signal modulation techniques is presented here to aid the reader with understanding of [Table 14.1](#) and the rest of the chapter.

14.1.1 On-Off Keying (OOK)

In **on-off keying (OOK)**, the carrier generator is switched on and off to transmit ones and zeros.

14.1.2 Frequency Shift Keying (FSK)

Frequency-shift keying (FSK) uses a change of the carrier frequency to transmit data. The simplest form of FSK is binary frequency-shift keying (BFSK), which uses a pair of alternating frequencies to transmit ones and zeros.

14.1.3 Gaussian Frequency Shift Keying (GFSK)

Gaussian frequency-shift keying (GFSK) is an improvement over basic FSK which does not switch between the different frequencies instantaneously, but uses a Gaussian filter to make the changes less abrupt, which reduces the side-band interference otherwise generated by the sharp edges. This scheme can be imagined as sending the binary waveform through a Gaussian filter and then modulating a voltage-controlled oscillator (VCO) with its output, rather than changing the VCO's control voltage discretely. GFSK is used in the Bluetooth standard.

14.1.4 Minimum-Shift Keying (MSK)

Minimum-shift keying (MSK) is another FSK-based modulation scheme. In MSK, the frequencies representing different symbols are chosen such that there are no sharp changes in the phase of the output waveform, the modulation is *phase-coherent*. This is another way to reduce side-band interference.

14.1.5 Gaussian Minimum-Shift Keying (GMSK)

Gaussian minimum-shift keying (GMSK) is a variant of MSK which uses a Gaussian filter to shape the digital signal before sending it to the oscillator. The principle is similar to GFSK, and it is a yet another way to reduce side-band interference and increase spectral efficiency.

14.1.6 LoRa Modulation

LoRa uses a direct sequence frequency hopping spread spectrum modulation scheme and can achieve very long range transmission. A higher-level specification defines how the devices using LoRa should behave in a large area network, though the modulation may be used for point-to-point connections as well.

LoRa is a proprietary technology developed by Semtech; it is free to use, but is available only with transceiver ICs produced by the company.

14.2 Comparing SX1276 and nRF24L01+

The SX1276 and nRF24L01+ transceivers have both been tested using the first GEX prototype, proving its usefulness as a hardware development tool, they proved capable of

fulfilling the requirements of the GEX radio link use-case. We compared them in Table 14.1 using data from their datasheets [55, 56]. It is apparent, after inspecting the table, that each has its strengths and weaknesses and the choice depends on the particular application's needs.

Table 14.1: Comparison of the SX1276 and nRF24L01+ wireless transceivers, using data from their datasheets (price in USD from DigiKey in a 10 pcs. quantity, recorded on May 6th 2018)

Parameter	SX1276	nRF24L01+
Connection	SPI (4 pins) + up to 6 IRQ	SPI (4 pins), CE, IRQ
Frequency band	868 MHz or 433 MHz	2.4 GHz
Data rate	up to 300 kbps	250–2000 kbps
Modulation	(G)FSK, (G)MSK, OOK, LoRa	GFSK
Range (est.)	over 10 km	up to 1 km
Consumption Rx	10.8–12 mA	12.6–13.5 mA
Consumption Tx	20–120 mA	7–11.3 mA
Idle power (max)	1 μ A sleep, 2 mA stand-by	0.9 μ A sleep, 320 μ A stand-by
Max packet size	300 bytes	32 bytes
Software reset	NRESET pin	not available
Extra	LoRa FHSS, packet engine	ShockBurst protocol engine
Price	\$7.3	\$1.6

The SX1276 supports additional modulation modes, including the proprietary LoRa scheme that can be received at long distances. The power consumption required to achieve this long-range communication makes it impractical for continuous operation on battery or solar power.

The nRF24L01+ provides higher data rates at short distances. Its power consumption is comparable or lower than that of the SX1276. It lacks a dedicated reset pin, but that can be worked around using an external transistor to momentarily disconnect it from the power supply.

Both devices implement some form of a packet engine with error checking; that of the nRF24L01+, called ShockBurst, is more advanced, as it implements acknowledgment responses and automatic re-transmission, leading to potentially more robust communication without additional overhead in the control software.

14.3 Wireless Link with the nRF24L01+

The nRF24L01+ was selected to be integrated into GEX thanks to its inclusion of the ShockBurst engine, higher possible data rates and significantly lower price. The SX1276,

nonetheless, remains an interesting option, should the need for a long range communication arise.

A pair of these radio modules can form a bidirectional data connection, functionally replacing **USB** or **UART** as a communication interface. However, we need to connect the second module to the **PC** to control GEX through the radio link. A separate **USB** device, a *wireless gateway*, was developed for this purpose; its hardware will be presented in **Section 15.5**.

14.3.1 The Wireless Gateway

The gateway presents itself to the host as a **CDC/ACM** device, much like the GEX modules themselves (here called *nodes*) when connected over **USB**. However, the standard GEX communication protocol cannot be used directly, as the gateway itself needs to be managed through the interface, and it can connect to more than one GEX module at once, necessitating an addressing scheme. This problem could be solved by adding a side channel, additional **USB** endpoints, to interact with the gateway itself; that option was not explored further, but it is clear that it would compromise our ability to use the simple virtual COM port **USB** driver.

The gateway has a 4-byte *network ID*, a number derived from the **MCU**'s unique ID number. The network ID must be entered into the system settings file of all nodes that wish to communicate with the gateway. Additionally, each module is assigned a 1-byte number serving as its address in the network. These addresses are loaded into the gateway by the user application, and are used to configure the nRF24L01+ to listen to messages from the corresponding nodes. The nRF24L01+ uses 5-byte addressing; the full node addresses are composed of the network ID and the one additional address byte.

14.3.2 The Gateway Protocol

The gateway protocol, when used to communicate with a node, encapsulates the raw binary data sent to or from connected nodes; the wrapped TinyFrame protocol remains unchanged.

All messages sent to or from the gateway are a multiple of 64 bytes long, padded with zeros if shorter. A message starts with a control byte determining its type, as summarized in the following table, listing the structure of all supported messages.

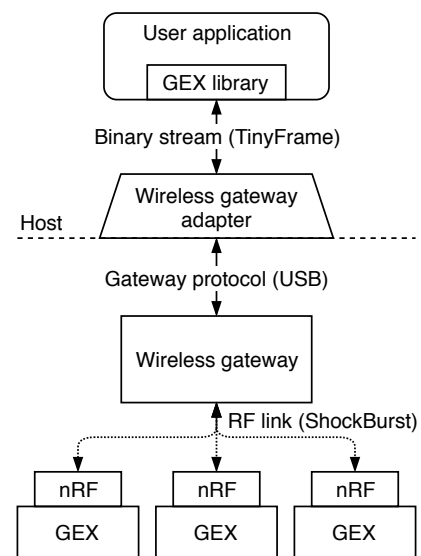

Figure 14.2: Wireless connection block diagram

First byte	Function	Structure
'r' (114)	RESTART Restart the gateway, disconnecting all nodes. This is functionally equivalent to re-plugging it to the USB port.	
'i' (105)	GET_NET_ID Read the unique 4-byte network ID. This command has no side effects and may be used as “ping” to verify the USB connection.	<i>Response:</i> <ul style="list-style-type: none"> • 0x01 • u8[4] network ID
'n' (110)	ADD_NODES Configure the gateway to listen for messages from the given nodes. Nodes may be removed using the RESTART command.	<i>Request:</i> <ul style="list-style-type: none"> • u8 count • u8[] node addresses
'm' (109)	SEND_MSG Send a binary message to one of the connected nodes. The message may span multiple 64-byte frames; the subsequent frames will contain only the payload bytes, or zero padding at the end of the last one.	<i>Request:</i> <ul style="list-style-type: none"> • u8 node address • u16 length • u8 checksum (inverted XOR of all payload bytes) • u8[] payload
0x02	INCOMING_MSG A message was received from one of the configured nodes. This is an event frame sent by the gateway to the host.	<i>Payload:</i> <ul style="list-style-type: none"> • u8 node address • u8 message length • u8[] payload

14.3.3 Gateway Initialization Procedure

A host program connecting to a node or nodes through the gateway should follow the following procedure to initialize and configure the gateway:

1. Send the “GET_NET_ID” command to test if the gateway is connected (and obtain its network ID as a side effect)
2. Restart the gateway using the “RESTART” command to clean any possible previous configuration; this is not needed when the gateway was restarted or freshly connected to the USB port.
3. Add the node address(es) using the “ADD_NODES” command.
4. Ping the connected node(s) through the GEX communication protocol to test the connection. Note that GEX will not use the radio module if USB is connected and enumerated, as it has lower priority.

Chapter 15

Hardware Realization

15.1 GEX on a STM32 Discovery Board

It has been proposed earlier in the text that STM32 Nucleo and Discovery development boards might serve as the hardware platform for this project. Indeed, a Discovery board with the STM32F072 was used to develop a major part of the GEX firmware, and the firmware remains compatible with it. This inexpensive board may be used to try GEX without the custom hardware.

15.1.1 Discovery STM32F072 Configuration and Pin Mapping

The Discovery board is fitted with four LEDs on GPIO pins PC6 through PC9, in a compass arrangement. The “north” LED, PC6, is used as the GEX status indicator. The “User” button, connected to PA0, is mapped as the GEX Lock button, controlling the settings storage.

We advise the reader, as a potential user of the board, to review its schematic diagram (found in the documentation [57]) and ensure the solder-jumpers on the back side are configured correctly:

- Jumpers SB20 and SB23 must be closed to enable the User USB connector.
- Jumper SB17 must be open and SB19 closed to use the 8 MHz clock signal provided by the on-board ST-Link programmer; the internal USB-synchronized 48 MHz oscillator will be used if the clock signal is not provided (SB19 open).
- Jumpers SB27 through SB32 should be closed to connect the GPIO pins normally dedicated to the touch sensing strip to the board’s header.

Capacitors C26, C27, and C28 are sampling capacitors for the TSC. There are, unfortunately, no jumpers available to disconnect them, and they interfere in high-speed signals on the used pins (PA3, PA7, and PB1). The only solution, when those pins are needed for another purpose, is to desolder the capacitors.

An accelerometer IC L3GD20 is fitted on the board, attached to SPI2 on pins PB13 (SCK), PB14 (MISO), and PB15 (MOSI), with NSS on pin PC0, and pins PC1 and PC2 used for interrupt flags. This chip cannot be disconnected or disabled and it is difficult to remove; care must be taken to avoid its interference on the used pins.

15.2 GEX Hub

GEX Hub was the first custom PCB designed for GEX. It uses the same microcontroller as the Discovery board, thus the firmware modifications needed to make it work with this new platform were minimal. The schematic diagram is attached in [Appendix A](#).

The Hub board provides access to all the **GPIO** pins¹ through three flat-cable connectors (IDC), one for each port; they also contain a ground and power supply connection to make the attachment of external boards or a breadboard easier, requiring just one cable. The use of flat cables, however, is not mandatory—the flat cable connectors are based on the standard 2.54 mm-pitch pin headers, allowing the user to use widely available “jumper wires”.

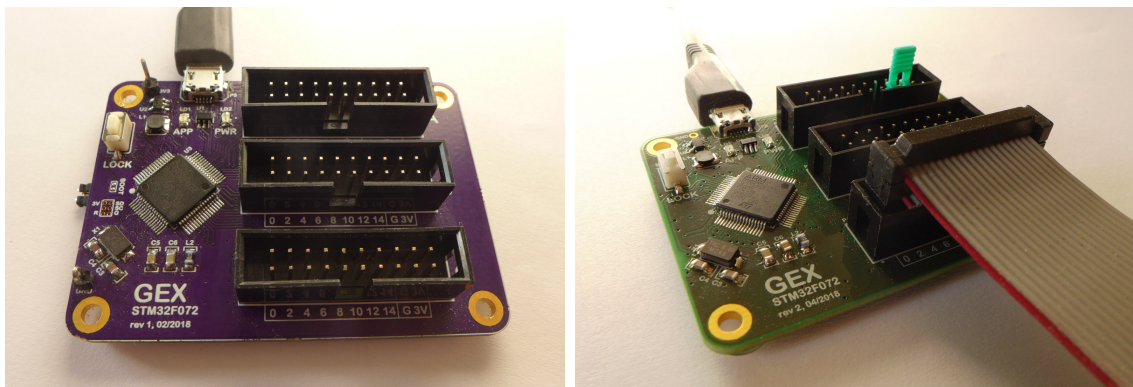

(a) : Revision 1

(b) : Revision 2

Figure 15.1: Two revisions of the GEX Hub module, rev. 2 shown with the boot jumper and one flat cable.

15.2.1 GEX Hub Errata

The first revision of the Hub board ([Figure 15.1a](#)) proved functional and helped us validate the power supply design and test the firmware, but contained one layout error that had to be manually fixed—the boot jumper and the programming header footprints, on the left side of the board, had too fine pitch and could not be populated.

An updated revision 2 of the board ([Figure 15.1b](#)), manufactured together with the GEX Zero PCBs ([Section 15.3](#)), removes the two problematic footprints altogether; a reorganization in the **GPIO** connectors allowed them to be moved together with the other pins.

The Boot jumper was meant to be closed during normal operation, to avoid it getting lost. Since revision 2 moved the boot pin into the top connector, this had to be changed; the jumper logic was inverted by changing its pull-up resistor to a pull-down. The bootloader is now activated by inserting a jumper into the connector, shorting the Boot pin (labeled “B”) to the adjacent 3.3 V pin.

¹With the exception of pins used by USB and the Lock button.

A restart is required, in all cases, for the boot jumper changes to take effect. Revision 2 adds a flat reset button on the back side of the board for this purpose, making the firmware update process more straightforward.

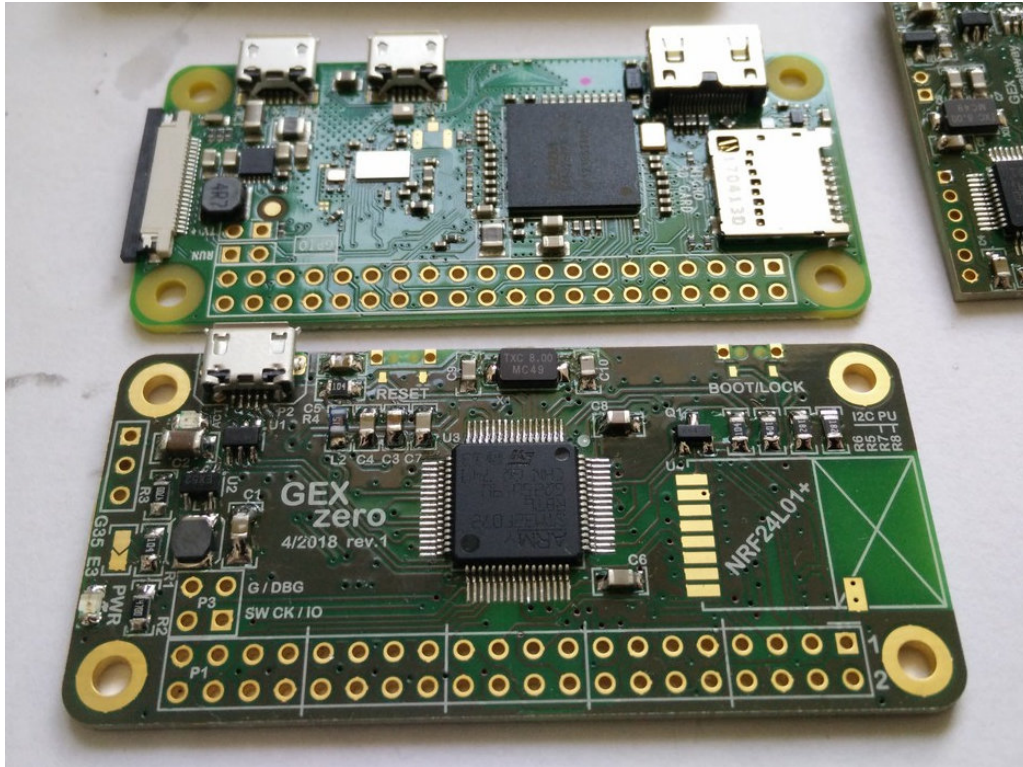

Figure 15.2: Comparison of Raspberry Pi Zero (top) with GEZ Zero (bottom), before soldering the header, buttons, and the wireless module.

15.3 GEX Zero

Our desire to re-use the form factor of the Raspberry Pi (RPi) Zero to exploit the existing accessory market has been mentioned already in [Section 2.5](#). It was brought to fruition with GEX Zero, the second realized GEX prototype ([Figure 15.3](#)). Its design involved several challenges given by constraints imposed by this form factor:

- It had to be a one-sided board, with no components on the bottom; this is needed for acrylic cases which sit flatly against the PCB, with a cut-out for the pin header.
- Buttons and the USB connector had to exactly align with connectors on the RPi Zero to fit the openings in its cases.
- The board size was fixed, and rather small; we used only two layers to save production cost, but this proved a significant challenge when routing connections to the pin header.



Figure 15.3: GEX Zero in the official Raspberry Pi Zero case, and an aftermarket acrylic case. The acrylic case is a better choice, as the button and the side connector are easier accessible, and the pin-out diagram on the back side of the board can be read without removing it.

- To make use of the Raspberry Pi add-on boards, called HATs or pHATs, a particular organization of the pin header was required. We'll discuss this in more detail below.

15.3.1 Pin Assignment

Like our STM32 microcontroller, the Broadcom processor on the RPi multiplexes its **GPIO** pins with alternate functions, and, likewise, each function is available only on a small selection of pins. The usual alternate function assignments of the RPi **GPIO** header can be found in [58] and [59].

The GEX Zero pin header's alternate functions had to match those on the RPi Zero header, so that the existing add-on boards can be used without modifications. By inspecting the alternate function tables in the STM32F072 datasheet [60], we found a layout that fulfills this requirement almost perfectly. The final assignment is shown in Table 15.1, and the full schematic diagram is attached in Appendix B.

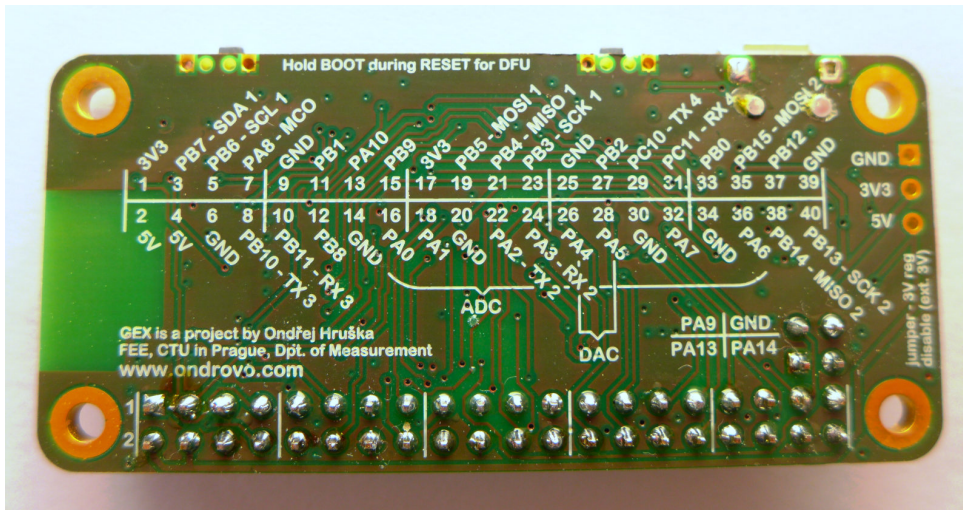

Figure 15.4: Pin assignment diagram on the back side of GEX Zero

GPIO ports A and B are fully exposed in the header, with the exception of pins PA11 and PA12 that are routed to the USB connector. The remaining positions were filled with pins from port C. The omitted “ID I²C” port on pins 27 and 28 is used by the RPi Zero to read configuration from an EEPROM chip on some add-on boards. As this is the only use of the I²C port, its lack is not a big limitation.

15.4 GEX Zero Errata

Unfortunately, neither the GEX Zero PCB was flawless in the first revision. The errors are minor and will not interfere much in the usage of the module. Nonetheless, they should be corrected in the next revision:

- The I²C pull-up resistor R8 is connected to PA8 instead of PB7. This can be fixed by cutting the trace near the GPIO header and rewiring it, or using an external 1.8 k Ω pull-up resistor on PB7, when the I²C connection is required.
- Pins PB14 and PB15 are swapped in the GPIO header, making the SPI port incompatible with add-on boards using this interface. Luckily, there is another SPI port on the header, which is routed correctly, somewhat mitigating this mistake.

15.5 Wireless Gateway

The wireless gateway was designed as a “USB dongle”, using the USB type A connector (Figure 15.5). It is fitted with an STM32F103 microcontroller, selected for its low cost and availability in small packages (in this case LQFP48)². The nRF24L01+ module is

²Ironically, the STM32F103 is more powerful than the MCU used in GEX Zero and GEX Hub. Porting GEX to this platform is planned for future development.

partly sticking outside the board outline, allowing the PCB to be smaller (and thus cheaper to manufacture), while reducing interference between components and copper plating on the board and the antenna. The schematic diagram of the wireless gateway is attached in [Appendix C](#).

Beyond the use with GEX, the gateway is a versatile tool which could be programmed with a different firmware and serve other purposes, e.g., as a wireless connection between two computers, to scan the radio spectrum for interference in order to find a clear channel, or to communicate with other devices that use the nRF24L01+ transceiver. The chosen microcontroller, unfortunately, does not include a USB bootloader, so a SWD programmer is required to change the firmware; SWD is routed to the pin header next to the wireless module.

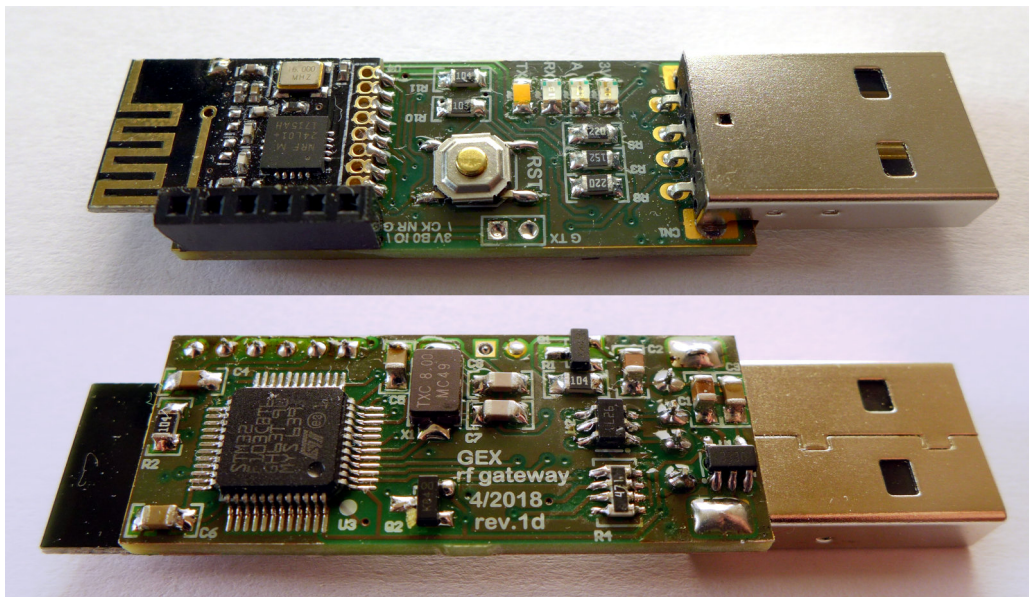

Figure 15.5: The wireless gateway (top and bottom side)

Table 15.1: Comparison of the RPi Zero and GEX Zero GPIO header pin assignments. Names in parentheses represent STM32F072 alternate functions (e.g., MISO1 is MISO of the first SPI peripheral). “*” marks pins without important alternate functions that could be assigned arbitrarily in the GEX Zero header. All power pins are identical in both headers.

Pin	RPi	GEX Zero	Pin	RPi	GEX Zero
1	3.3 V	–	2	5 V	–
3	I ² C SDA	PB7 (SDA1)	4	5 V	–
5	I ² C SCL	PB6 (SCL1)	6	GND	–
7	*	PA8 (MCO)	8	UART TX	PB10 (TX3)
9	GND	–	10	UART RX	PB11 (RX3)
11	UART RTS	PB1 (RTS3)	12	PWM	PB8
13	*	PA10	14	GND	–
15	*	PB9	16	*	PA0 (FCAP)
17	3.3 V	–	18	*	PA1
19	SPI MOSI	PB5 (MOSI1)	20	GND	–
21	SPI MISO	PB4 (MISO1)	22	*	PA2 (TX2)
23	SPI SCK	PB3 (SCK1)	24	*	PA3 (RX2)
25	GND	–	26	*	PA4 (DAC ₁)
27	ID I ² C SDA	PB2	28	ID I ² C SCL	PA5 (DAC ₂)
29	*	PC10 (TX4)	30	GND	–
31	*	PC11 (RX4)	32	PWM	PA7
33	PWM	PB0	34	GND	–
35	SPI MISO	PB14 (MISO2)	36	*	PA6 (CTS3)
37	*	PB12	38	SPI MOSI	PB15 (MOSI2)
39	GND	–	40	SPI SCK	PB13 (SCK2)

Chapter 16

Client Software

With the communication protocol clearly defined in [Chapters 12 and 13](#), and [Chapter 14](#) for the wireless gateway, the implementation of client libraries is relatively straightforward. Two have been developed as a proof-of-concept, in languages C and Python.

16.1 General Library Structure

The structure of a GEX client library is in all cases similar:

- **USB or serial port access**

This is the only platform-dependent part of the library. Unix-based systems provide a standardized POSIX API to configure the serial port. A raw access to **USB** endpoints is possible using the libUSB C library. Access to the serial port or **USB** from C on MS Windows has not been investigated, but should be possible using proprietary APIs.

Accessing the serial port or **USB** endpoints from Python is more straightforward thanks to the cross platform libraries *PySerial* and *PyUSB*.

- **TinyFrame implementation**

The *TinyFrame* protocol library can be used directly in desktop C applications, and it has been re-implemented in Python and other languages.

- **Higher-level GEX logic**

The host side of the communication protocol described in [Chapter 12](#) should be implemented as a part of the library. This includes the reading and writing of configuration files, unit list read-out, command payload building, and asynchronous event parsing.

Additional utilities may be defined on top of this basic protocol support for the command API of different GEX units, as described in [Chapter 13](#). Those unit-specific “drivers” are available in the provided Python library.

16.2 Python Library

The Python GEX library implements both a serial port access and raw access to **USB** endpoints. Its development has been prioritized over the C library because of its potential

to integrate with MATLAB, and because it promises to be the most convenient method to interact with GEX thanks to the ease-of-use that comes with the Python syntax. This library provides a high level **API** above the individual unit types, removing the burden of building and parsing of the binary command payloads from the user.

The library is composed of a *transport* class, the core class `gex.Client`, and unit classes (e.g., `gex.I2C` or `gex.SPI`).

Three transport implementations have been developed:

- `gex.TrxSerialSync` – virtual serial port access with polling for a response
- `gex.TrxSerialThread` – virtual serial port access with a polling thread and semaphore-based notifications
- `gex.TrxRawUSB` – similar to `gex.TrxSerialThread`, but using raw USB endpoint access

To use the wireless gateway, wrap either low-level transport in `gex.DongleAdapter`. The adapter configures the gateway and converts the regular protocol to the right format.

```
# Gateway connection example
transport = gex.DongleAdapter(gex.TrxRawUSB(remote=True), slave=42)
client = gex.Client(transport)
# ...
client.close()
```

16.2.1 Example Python Script

An example Python program displaying a test pattern on a **LED** matrix using the **I²C**-connected driver chip IS31FL3730 is presented in **Listing 3** as an illustration of the library usage. A photo of the produced **LED** pattern can be seen in **Figure 16.1**.

First, a client instance is created, receiving the transport as an argument. We use a `with` block in the example to ensure the transport is safely closed before the program ends, even if that happens due to an exception; this is similar to the `try-finally` pattern, but the de-initialization is done automatically. The client (and subsequently the transport) can be closed manually by calling its `.close()` method. Inside the `with` block, the script proceeds to create unit handles and use them to perform the desired task, in our case a communication with the **LED** matrix driver over the **I²C** bus.

16.3 MATLAB integration

The Python library can be accessed from MATLAB scripts thanks to MATLAB's two-way Python integration [61]. Controlling GEX from MATLAB may be useful when additional processing is required, e.g., with data from the **ADC**; however, in many cases, an open

```
#!/bin/env python3
# The I2C unit, called 'i2c', is configured to use PB6 and PB7
import gex
with gex.Client(gex.TrxRawUSB()) as client:
    bus = gex.I2C(client, 'i2c')
    addr = 0x61
    bus.write_reg(addr, 0x00, 0b00011000) # dual matrix
    bus.write_reg(addr, 0x0D, 0b00001110) # 34 mA
    bus.write_reg(addr, 0x19, 64) # set brightness
    # matrix 1
    bus.write_reg(addr, 0x01, [
        0xAA, 0x55, 0xAA, 0x55,
        0xAA, 0x55, 0xAA, 0x55
    ])
    # matrix 2
    bus.write_reg(addr, 0x0E, [
        0xFF, 0x00, 0xFF, 0x00,
        0xFF, 0x00, 0xFF, 0x00
    ])
    # update display
    bus.write_reg(addr, 0x0C, 0x01)
```

Listing 3: An example Python program using the GEX client library

source alternative native to Python exists that could be used for the same purpose, such as the NumPy and SciPy libraries [62].

The example in Listing 4 (and Figure 16.2) demonstrates the use of MATLAB to calculate the frequency spectrum of an analog signal captured with GEX. The syntax needed to use the serial port transport (instead of a raw access to USB endpoints) is shown in a comment.

16.4 C Library

The C library is more simplistic than the Python one; it supports only the serial port transport (UART or CDC/ACM) and does not implement asynchronous polling or the unit support drivers. The implemented features—the transport, a basic protocol handler, and payload building and parsing utilities—are sufficient for most applications, though less convenient than the Python library.

This low-level library is intended for applications where the performance of the Python implementation is insufficient, or where an integration with existing C code is required. The full API can be found in the library header files. A C version of the example Python script shown above, controlling an LED matrix driver, is presented in Listing 5. The payloads in this example are represented as binary strings for simplicity. Two better methods of

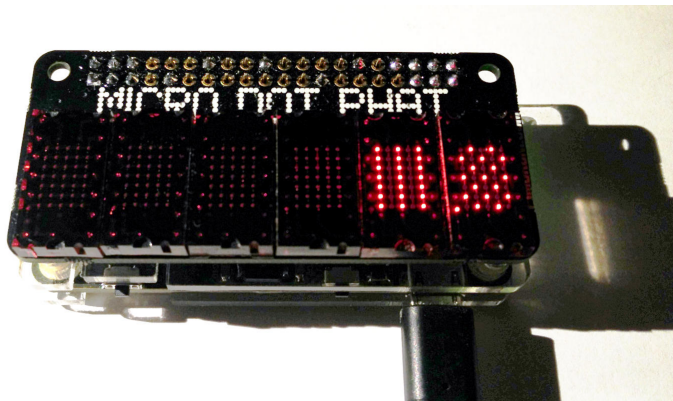

Figure 16.1: GEX Zero with the Micro Dot pHAT add-on board, showing a test pattern defined in a Python script

payload construction are available: using C structs, or taking advantage of the Payload Builder utility (bundled with TinyFrame).

■ 16.4.1 Structure-based Payload Construction

The structure-based method utilizes C structs to access individual fields in the payload. Simple payloads can be represented by a struct without problems, but payloads of a dynamic length pose a challenge; we can either define a new struct for each required length, or, when the variable-length array is located at the end of the payload, a struct with the largest needed payload size is defined and the real length is then specified when sending the message. The latter approach is illustrated in [Listing 6](#).

■ 16.4.2 Using the Payload Builder Utility

The Payload Builder utility offers a flexible solution to the construction of arbitrary binary payloads. It is used in the GEX firmware to construct messages and events, along with the binary settings storage content.

An example of Payload Builder's usage is shown in [Listing 7](#). We give it a byte buffer and it then fills it with the payload values, taking care of buffer overflow, and advancing the write pointer by the right number of bytes. The third parameter of `pb_init()` is optional, a pointer to a function called when the buffer overflows; this callback can flush the buffer and rewind it, or report an error.

Payload Builder is accompanied by Payload Parser, a tool doing the exact opposite. While it is not needed in our example, we will find this utility useful when processing command responses or events payloads. The full [API](#) of those utilities can be found in their header files.

```

% The ADC unit, called 'adc', is configured to use PA1 as Channel 0

%trx = py.gex.TrxSerialThread(pyargs('port', '/dev/ttyUSB1', ...
%                               'baud', 115200));
trx = py.gex.TrxRawUSB();
client = py.gex.Client(trx);
adc = py.gex.ADC(client, 'adc');

L = 1000; Fs = 1000;
adc.set_sample_rate(uint32(Fs)); % casting to unsigned integer
data = adc.capture(uint32(L));
data = double(py.array.array('f',data)); % numpy array to matlab format

Y = fft(data);
P2 = abs(Y/L);
P1 = P2(1:L/2+1);
P1(2:end-1) = 2*P1(2:end-1);
f = Fs*(0:(L/2))/L;

plot(f,P1)
client.close()

```

Listing 4: Calling the Python GEX library from a MATLAB script

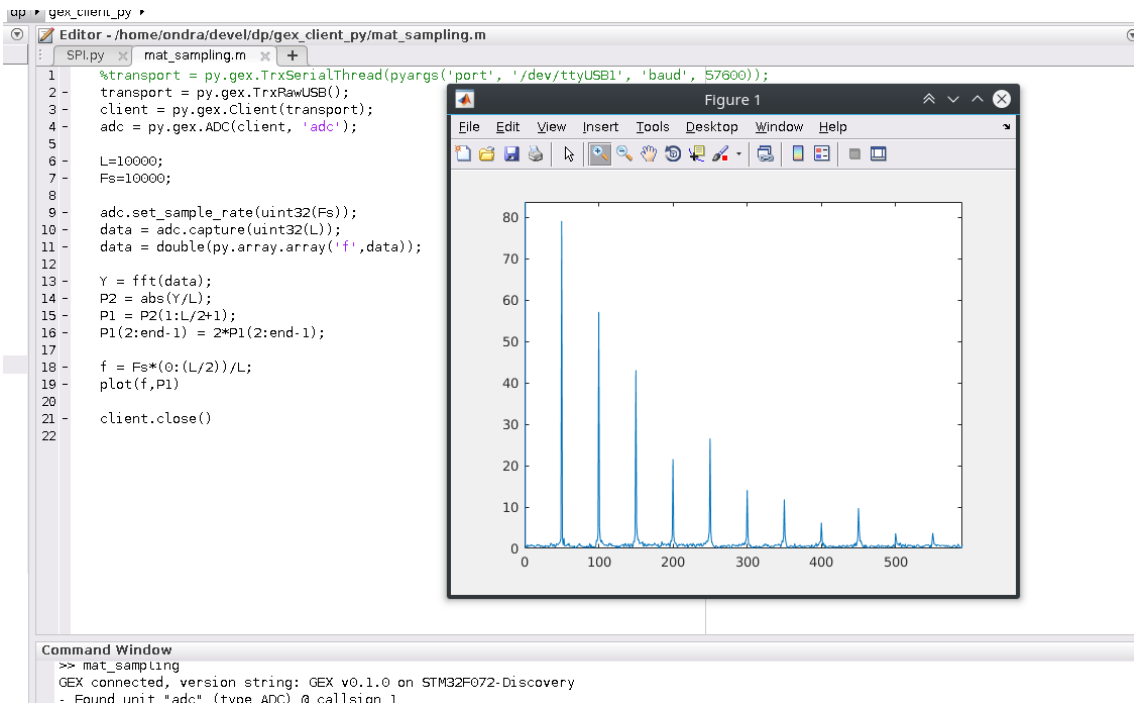

Figure 16.2: A demonstration of the MATLAB/Python integration

```

#include <signal.h>
#include <assert.h>
#include "gex.h"

void main(void)
{
    // Initialize GEX and the I2C unit handle
    GexClient *gex = GEX_Init("/dev/ttyACM0", 200);
    assert(NULL != gex);
    GexUnit *bus = GEX_GetUnit(gex, "i2c", "I2C");
    assert(NULL != bus);
    // Configure the matrix driver
    GEX_Send(bus, 2, (uint8_t*) "\x61\x00\x00\x18", 4);
    GEX_Send(bus, 2, (uint8_t*) "\x61\x00\x0d\x0e", 4);
    GEX_Send(bus, 2, (uint8_t*) "\x61\x00\x19\x40", 4);
    // Load data
    GEX_Send(bus, 2, (uint8_t*) "\x61\x00\x01"
              "\xAA\x55\xAA\x55\xAA\x55\xAA\x55", 11);
    GEX_Send(bus, 2, (uint8_t*) "\x61\x00\x0e"
              "\xFF\x00\xFF\x00\xFF\x00\xFF\x00", 11);
    // Update display
    GEX_Send(bus, 2, (uint8_t*) "\x61\x00\x0c\x01", 4);

    GEX_DeInit(gex);
}

```

Listing 5: An example C program (GNU C99) controlling GEX using the low-level GEX library; this code has the same effect as the Python script shown in [Listing 3](#), with payloads built following the command tables from [Chapter 13](#).

```

struct i2c_write {
    uint16_t address;
    uint8_t reg;
    uint8_t value[8]; // largest needed payload size
} __attribute__((packed));

// 1-byte value
GEX_Send(bus, 2, (void *) &(struct i2c_write) {
    .address = 0x61,
    .reg = 0x00,
    .value = {0x18},
}, 3 + 1); // use only 1 byte of the value array

// 8-byte value
GEX_Send(bus, 2, (void *) &(struct i2c_write) {
    .address = 0x61,
    .reg = 0x01,
    .value = {0xAA, 0x55, 0xAA, 0x55, 0xAA, 0x55, 0xAA, 0x55},
}, 3 + 8);

```

Listing 6: The variable-length struct approach to payload building

```

uint8_t buff[20];
PayloadBuilder pb;

pb = pb_init(&buff, 20, NULL);
pb_u16(&pb, 0x61);
pb_u8(&pb, 0x00);
pb_u8(&pb, 0x18);
GEX_Send(bus, 2, buff, pb_length(&pb));

pb_rewind(&pb); // reset the builder for a new frame

uint8_t screen[8] = {0xAA, 0x55, 0xAA, 0x55, 0xAA, 0x55, 0xAA, 0x55};
pb_u16(&pb, 0x61);
pb_u8(&pb, 0x01);
pb_buf(&pb, &screen, 8);
GEX_Send(bus, 2, buff, pb_length(&pb));

```

Listing 7: Building and sending payloads using the PayloadBuilder utility



Part IV

Results

Chapter 17

Example Applications

This chapter presents several applications of GEX. Those examples are the result of testing during the firmware development, and do not cover the full range of features, but should give the reader some idea about the possibilities.

17.1 Frequency Response Measurement

The frequency response of a filter may be measured with a combination of the **ADC** and **DAC** units. The **DAC** is configured to generate a sine wave as a stimulus for the filter, while the **ADC** captures the output waveform. By varying the generated frequency and measuring the amplitude, we obtain a frequency response of the filter. If we measured both the input and output, we could calculate the phase shift and produce a real Bode diagram.

Figure 17.1 depicts a simple test setup with a passive RC filter; its characteristics in the low-pass and high-pass configuration, as obtained with GEX, are shown in **Figure 17.2**.

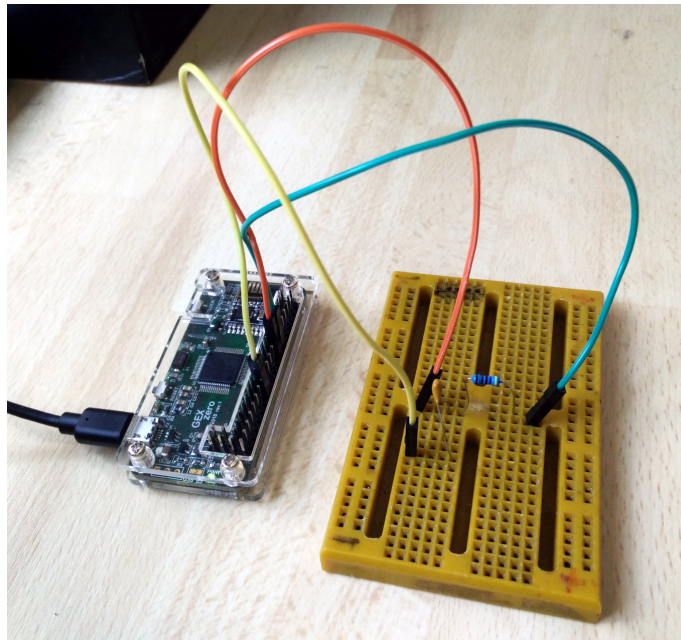

Figure 17.1: GEX Zero measuring a passive high-pass RC filter

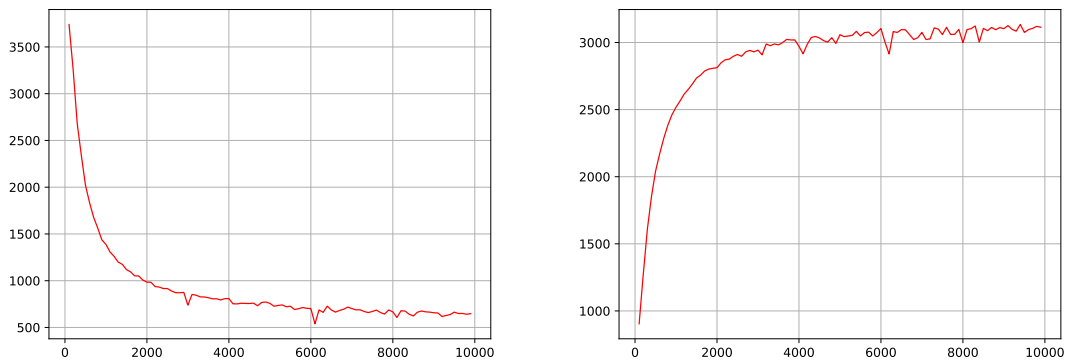
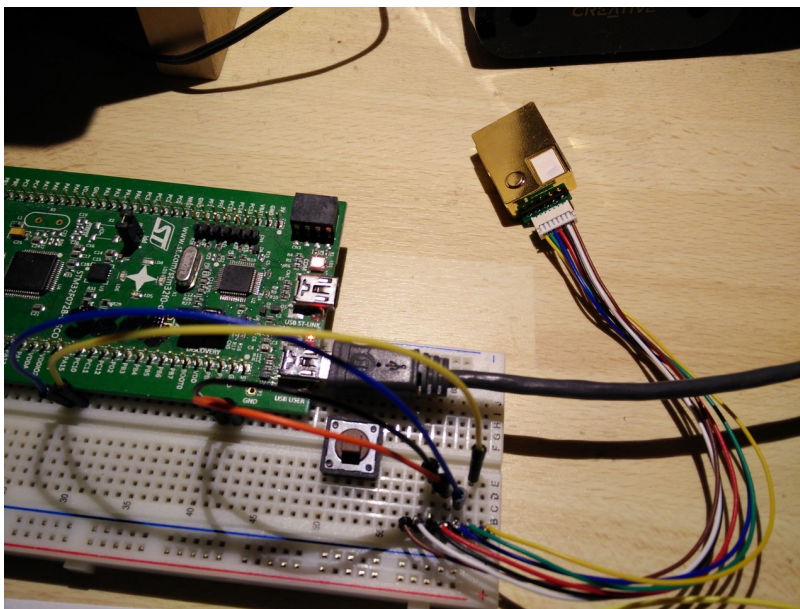

Figure 17.2: Frequency response of two complementary passive RC filters, captured by GEX controlled with a Python script. X: frequency (Hz), Y: peak-to-peak voltage as a raw ADC word

17.2 Measuring CO₂ Concentration

The **NDIR** CO₂ sensor MH-Z19B provides both a **UART** interface, and a pulse-width modulated signal with a duty cycle proportional to the CO₂ concentration. We used it to verify the duty cycle measurement functionality of the frequency capture unit, and also tested the **USART** unit with the digital interface. The measured concentration was displayed using the **SIPO** unit on a 74HC595-drive red-green **LED** bargraph (Figure 17.3).



(a) : CO₂ concentration measurement

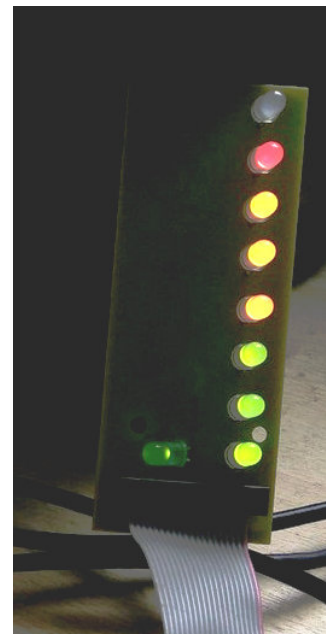

(b) : LED display

Figure 17.3: GEX firmware on the Discovery board reading CO₂ concentration from the MH-Z19B **NDIR** sensor and displaying the concentration on an **LED** bargraph

17.3 Controlling the “Micro Dot pHAT”

The “Micro Dot pHAT” add-on board was used to test GEX Zero’s compatibility with pHATs. A photo of the pHAT on GEX Zero, together with example scripts, was presented in [Section 16.2.1](#). While this board does not provide any useful functionality beyond displaying **LED** patterns, it is a proof that third-party add-ons for the RPi Zero may be compatible with GEX, which introduces many interesting possibilities.

17.4 Capturing Transient Effects

The **ADC** unit supports level-based triggering. This was tested first by capturing the charging waveform of a capacitor ([Figure 17.4](#)). As the triggering voltage had to be placed above the noise floor, the triggering condition occurred when a part of the waveform already passed. This was solved by using the pre-trigger feature to include past records at the beginning of the capture.

A more interesting application of level triggering was discovered by accident during a thunderstorm, when the electromagnetic interference from a (remote) lightning strike caused a voltage spike to appear on an oscilloscope probe. Investigating the phenomenon, we devised a simple “lightning trap” circuit ([Figure 17.5](#)). The resistor forms a discharge path for the capacitor, which acts as a high-pass filter of sorts. The voltage on the **ADC** input remains at about half of the operating range, and lightning strikes produce bursts of voltage spikes which we can trigger on and record.

This method of lightning detection should be regarded as a mere curiosity without much scientific value, and the circuit could certainly be improved to be safer and more sensitive. Nonetheless, the simple setup proved functional and several lightning strikes were automatically captured ([Figure 17.6](#)).

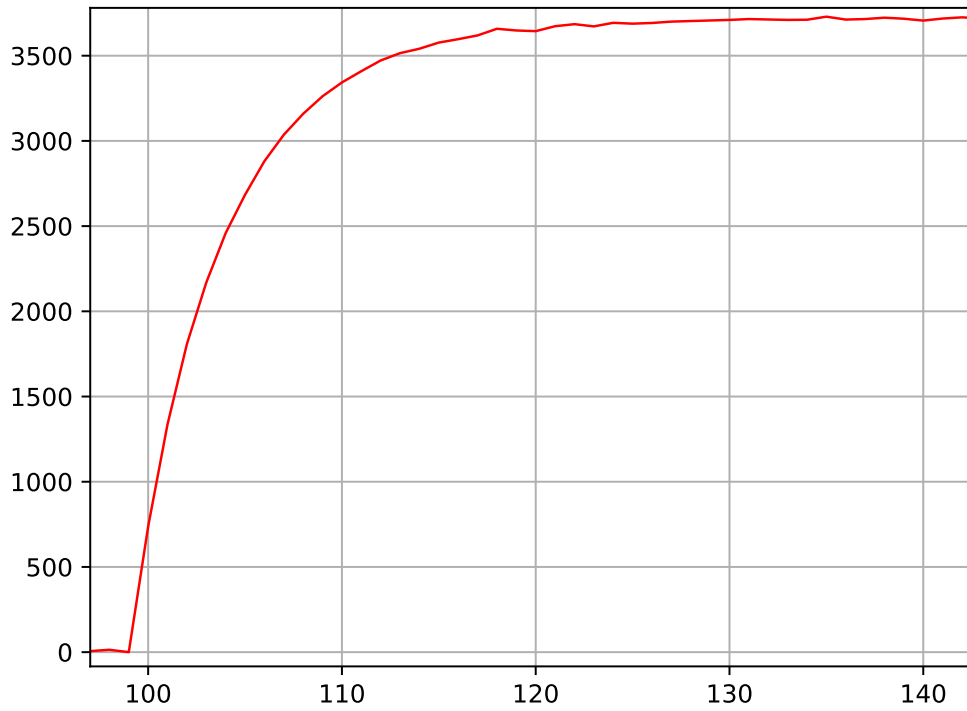

Figure 17.4: Capacitor charging waveform captured by the ADC unit, 50 kS/s. X: sample number, Y: ADC word. X grid: 200 μ s.

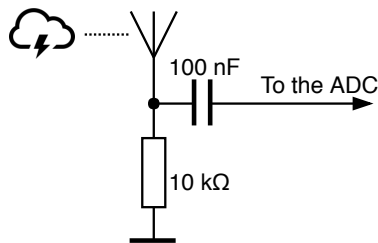

Figure 17.5: The “lightning trap” circuit

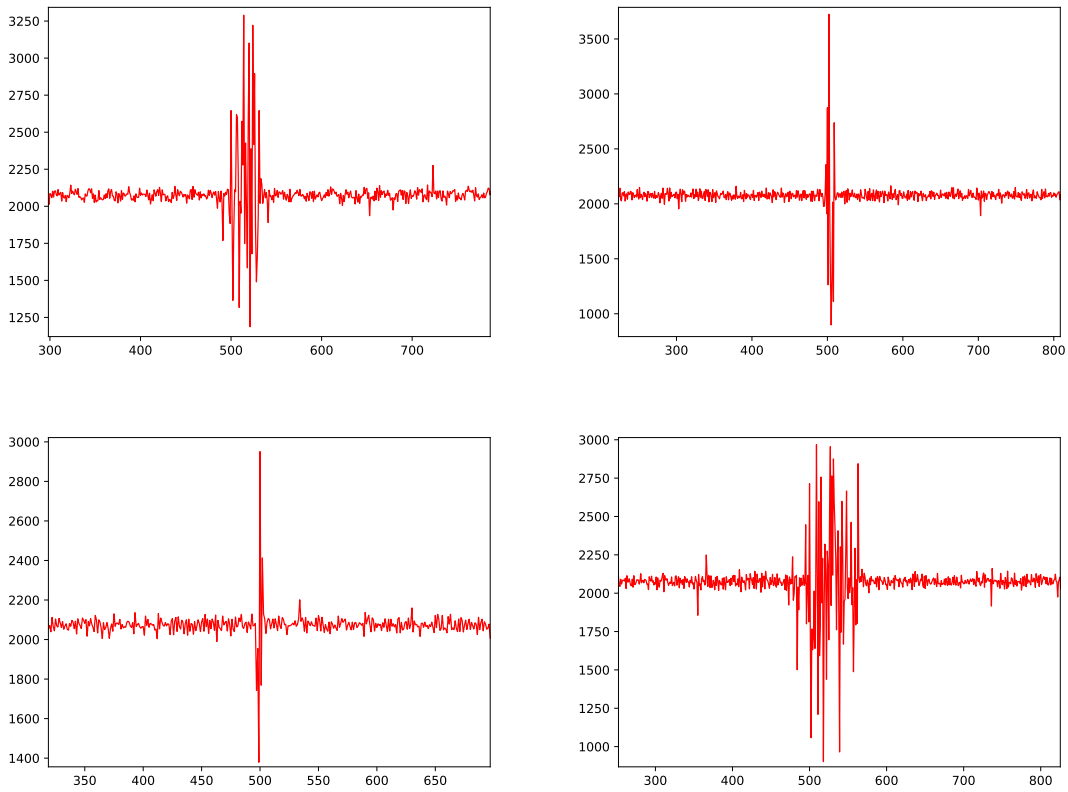

Figure 17.6: Lightning strike-generated bursts of energy captured by the ADC unit. Note the X-axis value 500 where the bursts start: that was the configured pre-trigger length

Chapter 18

Discussion

The objective of this work was to develop an extensible platform allowing the user to interact with hardware modules and circuitry from high-level applications running on their **PC**, in other words, to “bring the Raspberry Pi **GPIO** header to the **PC**”. It was important to design the platform in such a way that a user without much experience with embedded electronics and low level circuitry could still use it with a reasonable level of comfort and confidence.

18.1 Solution Summary

We based the *GEX* platform around STM32 microcontrollers from ST Microelectronics and developed the initial version for the STM32F072. This **MCU** was chosen for its native **USB Full Speed** support, its interesting set of peripheral blocks, and because it is a relatively recent model in the STM32F series, expecting it to be mature and without major flaws. A wireless connection was planned together with **USB** and hardware **UART**, for which we chose the nRF24L01+ transceiver from Nordic Semiconductor.

In total, three custom hardware modules have been developed and realized for the project: GEX Hub, GEX Zero, and the wireless gateway. GEX Hub verified the designed schematic and general functionality of the module. GEX Zero is more advanced and compact than GEX Hub, also offering wireless connectivity for field experiments; we re-used the form factor of the Raspberry Pi Zero for this board, which makes it compatible with many existing enclosures and add-on boards. In addition to custom hardware, the GEX firmware may be flashed to STM32 development boards (“STM32F072B-DISCO”).

The initial version of the project supports the following hardware buses and functions:

- **Digital input** with asynchronous pin change detection
- **Digital output** with pulse generation support
- **Digital communication interfaces:**
 - **SPI** with up to 16 slaves and multicast support
 - **I²C** master
 - **USART** with optional RS-485 driver support
 - **1-Wire** master, implementing the **ROM Search** algorithm

- **Frequency, pulse width, and duty cycle measurement**
- **Pulse counting**
- **PWM signal generation**
- **Multi-channel shift register loading**
- **NeoPixel RGB LED strip control**
- **Capacitive touch sensing**
- **Analog signal acquisition**
 - Immediate or averaged voltage measurement
 - Isochronous sampling: fixed sample count, or a continuous stream
 - Threshold-based triggering with a pre-trigger buffer
- **Analog signal generation**
 - Sine, triangle, sawtooth, or rectangle waveform generation using **DDS**
 - **DC** level output

We developed a transaction-based binary protocol that is used by all three communication interfaces. Software libraries implementing this protocol have been developed in programming languages C and Python. It has been tested and verified that the Python library may be integrated into MATLAB scripts, should the user need MATLAB, e.g., for data processing or visualization.

To make the devices easy to reconfigure, the configuration options—such as, which features to enable and what pins to use for them—are presented by entries in INI configuration files. The user can edit these files in a virtual **USB** mass storage device with an emulated FAT16 file system. Because the emulation relies on a certain pattern of behavior from the host, it may not work reliably in all cases. This is mitigated by making the files accessible also through the communication interface.

■ 18.2 Results and Possible Applications

The designed device, and the accompanying software stack, make a practical tool for the research and development in the field of embedded electronics, and may be used as a learning aid to demonstrate the timings and format of the various supported hardware buses. The inclusion of analog signal acquisition and generation features makes it possible to measure the analog characteristics of electronic components, or acquire data from physical phenomena.

The use in automation offers itself thanks to the programmatic control from high level programming languages on the **PC**; this has an advantage over programming the embedded firmware itself in that the user can focus on the behavior of the device they are developing, rather than having to deal with low level implementation details, such as memory management, or interrupt priority configuration. An inherent downside of this

universal platform lies in greater latencies and lower performance than could be achieved with a custom embedded system.

As the GEX platform is open source, with all source code and hardware materials made available on GitHub [63], our solution may be freely expanded and adapted to support other hardware platforms, to add new features, or to further optimize its performance.

18.3 Comparison with Existing Solutions

The integration of the PC with low-level hardware is an appealing idea that has been explored in several alternative solutions, which we listed in Chapter 3. It is our belief that the GEX project offers enough unique features and qualities to find its place among the competition.

Compared to the Raspberry Pi, GEX is less powerful and cannot be used as a stand-alone device without the host PC. However, it is more straightforward to use, the required configuration is minimal, and it offers features not available in the Raspberry Pi, such as the ADC and DAC.

The Bus Pirate excels as a bus analyzer and general purpose device and implements features we did not explore in this project, while having much fewer GPIO pins, a lower resolution of the ADC, and completely misses a DAC. The two projects serve a slightly different purposes and appear to be complementary.

It is clear that GEX does not pose a real threat to professional tools in terms of performance, but even at the prototype cost it is significantly more affordable. By integrating many diverse features, GEX can replace several instruments at once, allowing the creation of more advanced measurement systems in a compact form.

18.4 Limitations

Our solution was designed with the expectation that the users are familiar with programming, and the requirement to develop a control script or application would not pose a problem. However, that is not universally true, and some users who might benefit from the platform will not be able to use it without a more user-friendly interface.

The STM32F072 microcontroller proved sufficient for the verification of the design, and in many cases provides a sufficient performance. Future expansion of the project is, unfortunately, limited by its flash and RAM capacity, which are already used at about 85%, based on the size of the binary image and the amount of allocated memory. Further, the STM32F072 has a Cortex-M0 core without any hardware support for floating point arithmetics, making any calculations with those numbers slow and requiring additional library functions, further increasing the firmware image size. The modules' power consumption has not been measured or optimized, but the inclusion of a wireless interface predisposes them to be used in battery-powered applications; the microcontroller choice and the power supply design may need to be revised for efficient battery operation.

Another limitation concerns the support software; our client libraries have not been tested on MS Windows, with Linux being the main development platform. The C library uses POSIX [API](#) and UNIX-specific [API](#) to manage the serial port, which is not portable. The Python library should work on MS Windows, provided libUSB is installed correctly. Further, on MS Windows prior to version 10, the virtual COM port connection requires the “STM32 Virtual COM port driver” to be manually installed and assigned in the Device Manager.

■ 18.5 Future Development

Future development of the project might focus on expanding the number of supported hardware platforms in order to overcome the limitations of the used microcontroller model. In particular the STM32L series of low-power devices should be investigated, as it may be a better choice when a battery-based operation is needed. The hardware implementation should further be revised to maximize power efficiency.

The client libraries need to be tested on other operating systems, and the C library may be expanded to provide a higher level of comfort to the user. The client library could further be reimplemented in more programming languages, such as Java or C#, and graphical applications could be developed to make GEX more approachable to users less familiar with programming.

GEX Zero, with the Raspberry Pi Zero form factor, introduced the possibility of using Raspberry Pi add-on boards. It would be interesting to test the compatibility with more such existing boards, and further to explore the possibility of designing custom ones. An add-on board could, for instance, add access to the [DALI](#) bus, RS-485, [CAN](#), or Ethernet.



Chapter 19

Conclusion

We have developed an open-source software and hardware platform providing high-level user applications running on a **PC** with access to **GPIO** pins, common hardware buses, and signal acquisition and generation functions.

The platform consists of a FreeRTOS-based firmware for the STM32F072 microcontroller, custom hardware module designs (including realized prototypes), and support software libraries for programming languages C and Python, the latter also compatible with MATLAB. The firmware may be used with the custom hardware, or with existing STM32 development boards.

The devices are connected to the **PC** by one of three interfaces: **USB** as a virtual COM port or with raw endpoint access, a hardware **UART**, or a radio link with the nRF24L01+ transceiver. Configuration is performed by editing INI files exposed in an emulated FAT16 file system through the **USB** connection, or programmatically.

The developed platform can be used as an learning aid, as an inexpensive development tool replacing professional laboratory equipment, or for automation purposes, taking advantage of its hardware interfacing capabilities to connect to multiple sensors and actuators.

Future development should focus on expanding support to other **MCU** models, adding new features, improving the software libraries, and providing a more user-friendly control interface.

Bibliography

- [1] Seeed Technology Co.,Ltd. *Bus Pirate v4*. URL: <https://www.seeedstudio.com/Bus-Pirate-v4-p-740.html> (visited on 05/12/2018).
- [2] Ian Lesnet. *Bus Pirate*. URL: http://dangerousprototypes.com/docs/Bus_Pirate (visited on 05/20/2018).
- [3] National Instruments. *I²C/SPI Interface Device*. URL: <https://www.ni.com/en-gb/shop/select/i2c-spi-interface-device> (visited on 05/12/2018).
- [4] National Instruments. *USB-6008*. URL: <http://www.ni.com/en-gb/support/model.usb-6008.html> (visited on 05/12/2018).
- [5] Total Phase, Inc. *USB-6008 product page*. URL: <https://www.totalphase.com/products/aardvark-i2cspi/> (visited on 05/12/2018).
- [6] USB Implementers Forum, Inc. *Universal Serial Bus Specification*. Tech. rep. 2000. URL: http://www.usb.org/developers/docs/usb20_docs/ (visited on 05/12/2018).
- [7] Craig Peacock. *USB in a NutShell*. URL: <https://www.beyondlogic.org/usbnutshell> (visited on 05/12/2018).
- [8] MQP Electronics Ltd. *USB Made Simple*. 2008. URL: <http://www.usbmadesimple.co.uk/> (visited on 05/12/2018).
- [9] Microsoft Corporation. *Windows 2000 Professional Resource Kit / USB Functions*. 2008. URL: [https://docs.microsoft.com/en-us/previous-versions/windows/it-pro/windows-2000-server/cc939102\(v%3dtechnet.10\)](https://docs.microsoft.com/en-us/previous-versions/windows/it-pro/windows-2000-server/cc939102(v%3dtechnet.10)) (visited on 05/12/2018).
- [10] USB Implementers Forum, Inc. *USB Class Codes*. Tech. rep. 2016. URL: http://www.usb.org/developers/defined_class (visited on 05/12/2018).
- [11] *pid.codes, a registry of USB PID codes for open source hardware projects*. URL: <http://pid.codes/> (visited on 05/12/2018).
- [12] EEVblog Electronics Community Forum. *Driving the 1K5 USB pull-up resistor on D+*. URL: <https://www.eevblog.com/forum/projects/driving-the-1k5-usb-pull-up-resistor-on-d/> (visited on 05/12/2018).
- [13] USB Implementers Forum, Inc. *USB Mass Storage Class, Specification Overview*. Tech. rep. 2010. URL: http://www.usb.org/developers/docs/devclass_docs/Mass_Storage_Specification_Overview_v1.4_2-19-2010.pdf (visited on 05/12/2018).

- [14] USB Implementers Forum, Inc. *USB Mass Storage Class, Bulk-Only Transport*. Tech. rep. 1999. URL: http://www.usb.org/developers/docs/devclass_docs/usbmassbulk_10.pdf (visited on 05/12/2018).
- [15] *Discussion in a USB storage driver development mailing list (site defunct, available via Archive.org)*. 2004. URL: <https://lists.one-eyed-alien.net/pipermail/usb-storage/2004-September/000795.html> (visited on 05/12/2018).
- [16] Jan Axelson. *Mass Storage FAQ*. 2013. URL: http://janaxelson.com/mass_storage_faq.htm (visited on 05/12/2018).
- [17] USB Implementers Forum, Inc. *Class definitions for Communication Devices 1.2*. Tech. rep. 2010. URL: http://www.usb.org/developers/docs/devclass_docs/CDC1.2_WMC1.1_012011.zip (visited on 05/12/2018).
- [18] USB Implementers Forum, Inc. *USB Interface Association Descriptor, Device Class Code and Use Model*. Tech. rep. 2003. URL: http://www.usb.org/developers/docs/whitepapers/iadclasscode_r10.pdf (visited on 05/12/2018).
- [19] Real Time Engineers Ltd. *FreeRTOS Ports*. URL: <https://www.freertos.org/a00090.html> (visited on 05/12/2018).
- [20] *The FreeRTOS™ Reference Manual*. Real Time Engineers Ltd., 2018. URL: https://www.freertos.org/Documentation/FreeRTOS_Reference_Manual_V10.0.0.pdf (visited on 05/12/2018).
- [21] Richard Barry. *Mastering the FreeRTOS™ Real Time Kernel. A Hands-On Tutorial Guide*. Real Time Engineers Ltd., 2016. URL: https://www.freertos.org/Documentation/161204_Mastering_the_FreeRTOS_Real_Time_Kernel-A_Hands-On_Tutorial_Guide.pdf (visited on 05/12/2018).
- [22] Real Time Engineers Ltd. *How FreeRTOS Works: FreeRTOS Implementation*. URL: <https://www.freertos.org/implementation/main.html> (visited on 05/12/2018).
- [23] Wikipedia contributors. *Comparison of File Systems: OS Support*. URL: https://en.wikipedia.org/wiki/Comparison_of_file_systems#OS_support (visited on 05/12/2018).
- [24] Microsoft Corporation. *How FAT Works*. 2009. URL: [https://docs.microsoft.com/en-us/previous-versions/windows/it-pro/windows-server-2003/cc776720\(v=ws.10\)](https://docs.microsoft.com/en-us/previous-versions/windows/it-pro/windows-server-2003/cc776720(v=ws.10)) (visited on 05/12/2018).
- [25] Jack Dobiash. *FAT16 Structure Information*. 1999. URL: <http://home.teleport.com/~brainy/fat16.htm> (visited on 05/12/2018).
- [26] LKT Software. *FAT16 File System*. 1999. URL: http://www.maverick-os.dk/FileSystemFormats/FAT16_FileSystem.html (visited on 05/12/2018).
- [27] Bob Eager. *A tutorial on the FAT file system*. 2017. URL: <http://www.tavi.co.uk/phobos/fat.html> (visited on 05/12/2018).
- [28] Microsoft Corporation. *FAT: General Overview of On-Disk Format*. Tech. rep. 2000. URL: <https://staff.washington.edu/dittrich/misc/fatgen103.pdf> (visited on 05/12/2018).
- [29] vinDaci. *Long Filename Specification*. 1998. URL: <http://home.teleport.com/~brainy/lfn.htm> (visited on 05/12/2018).

- [30] ARM Limited. *Arm Mbed DAPLink*. 2018. URL: <https://github.com/ARMmbed/DAPLink> (visited on 05/12/2018).
- [31] NKC Electronics. *Retrofitting AutoReset feature into an old Arduino serial board*. URL: <https://playground.arduino.cc/Learning/AutoResetRetrofit> (visited on 05/13/2018).
- [32] SD Group. *SD Specifications, Part 1: Physical Layer Simplified Specification*. Tech. rep. 2010. URL: https://www.cs.utexas.edu/~simon/395t_os/resources/Part_1_Physical_Layer_Simplified_Specification_Ver_3.01_Final_100518.pdf (visited on 05/13/2018).
- [33] NXP Semiconductors. *I2C-bus specification and user manual*. 2014. URL: <https://www.nxp.com/docs/en/user-guide/UM10204.pdf> (visited on 05/12/2018).
- [34] Jared Becker Jonathan Valdez. *Understanding the I2C Bus*. Tech. rep. 2015. URL: <http://www.ti.com/lit/an/slva704/slva704.pdf> (visited on 05/12/2018).
- [35] Dallas Semiconductor. *AN214: Using a UART to Implement a 1-Wire Bus Master*. Tech. rep. URL: <https://www.maximintegrated.com/en/app-notes/index.mvp/id/214> (visited on 05/13/2018).
- [36] Dallas Semiconductor. *DS18S20 High Precision 1-Wire Digital Thermometer*. Tech. rep. URL: <https://datasheets.maximintegrated.com/en/ds/DS18S20.pdf> (visited on 05/13/2018).
- [37] Dallas Semiconductor. *AN162: Interfacing the DS18X20/DS1822 1-Wire Temperature Sensor in a Micro-controller Environment*. Tech. rep. URL: <https://www.maximintegrated.com/en/app-notes/index.mvp/id/162> (visited on 05/13/2018).
- [38] SiTime Corporation. *AN10033: Frequency Measurement Guidelines for Oscillators*. Tech. rep. URL: <https://www.sitime.com/api/gated/AN10033-Frequency-Measurement-Guidelines-for-Oscillators.pdf> (visited on 05/13/2018).
- [39] Paul Boven. “Increasing the resolution of reciprocal frequency counters”. In: *Proceedings of the 50. VHF meeting in Weinheim*. URL: <https://www.febo.com/pipermail/time-nuts/attachments/20071201/e7833af5/attachment.pdf> (visited on 05/13/2018).
- [40] Maxim Integrated. *AN1080: Understanding SAR ADCs: Their Architecture and Comparison with Other ADCs*. Tech. rep. 2001. URL: <https://pdfserv.maximintegrated.com/en/an/AN1080.pdf> (visited on 05/13/2018).
- [41] Eva Murphy and Colm Slattery. “All about direct digital synthesis”. In: *Ask The Application Engineer* 33 (2004). URL: <http://www.analog.com/media/en/analog-dialogue/volume-38/number-3/articles/all-about-direct-digital-synthesis.pdf>.
- [42] ST Microelectronics. *RM0091: STM32F0x1/STM32F0x2/STM32F0x8 reference manual*. 2017. URL: http://www.st.com/resource/en/reference_manual/dm00031936.pdf (visited on 05/12/2018).
- [43] ST Microelectronics. *STM32L4 training: Touch Sensing Controller*. Tech. rep. 2017. URL: http://www.st.com/resource/en/product_training/stm3214_peripheral_touchsense.pdf (visited on 05/12/2018).

- [44] ST Microelectronics. *Touch Sensing Controller (TSC) presentation*. Tech. rep. 2015. URL: <https://wenku.baidu.com/view/8472044a6137ee06eef9180c.html?re=view> (visited on 05/12/2018).
- [45] ST Microelectronics. *AN4299: Guidelines to improve conducted noise robustness on STM32F0 Series, STM32F3 Series, STM32L0 Series and STM32L4 Series touch sensing applications*. Tech. rep. 2018. URL: http://www.st.com/resource/en/application_note/dm00085385.pdf (visited on 05/12/2018).
- [46] ST Microelectronics. *AN4310: Sampling capacitor selection guide for MCU based touch sensing applications*. Tech. rep. 2015. URL: http://www.st.com/resource/en/application_note/dm00087593.pdf (visited on 05/12/2018).
- [47] ST Microelectronics. *AN4312: Guidelines for designing touch sensing applications with surface sensors*. Tech. rep. 2017. URL: http://www.st.com/resource/en/application_note/dm00087990.pdf (visited on 05/12/2018).
- [48] ST Microelectronics. *AN4316: Tuning a STMTouch-based application*. Tech. rep. 2015. URL: http://www.st.com/resource/en/application_note/dm00088471.pdf (visited on 05/12/2018).
- [49] USB Implementers Forum, Inc. *USB Device Class Specification for Device Firmware Upgrade*. Tech. rep. 2004. URL: http://www.usb.org/developers/docs/devclass_docs/DFU_1.1.pdf (visited on 05/17/2018).
- [50] Harald Welte and Stefan Schmidt and Tormod Volden. *dfu-util*. 2016. URL: <http://dfu-util.sourceforge.net/> (visited on 05/17/2018).
- [51] ST Microelectronics. *STSW-STM32102: STM32 Virtual COM Port Driver*. URL: <http://www.st.com/en/development-tools/stsw-stm32102.html> (visited on 05/17/2018).
- [52] ST Microelectronics. *STM32Cube initialization code generator*. URL: <http://www.st.com/en/development-tools/stm32cubemx.html> (visited on 05/18/2018).
- [53] Ondřej Hruška. *TinyFrame, a library for building and parsing data frames for serial interfaces*. URL: <https://github.com/MightyPork/TinyFrame> (visited on 05/13/2018).
- [54] “IEEE Standard for Floating-Point Arithmetic”. In: *IEEE Std 754-2008* (2008), pp. 1–70. DOI: [10.1109/IEEESTD.2008.4610935](https://doi.org/10.1109/IEEESTD.2008.4610935).
- [55] Semtech Corporation. *SX1276/77/78/79 datasheet*. 2016. URL: https://www.semtech.com/uploads/documents/DS_SX1276-7-8-9_W_APP_V5.pdf (visited on 05/12/2018).
- [56] Nordic Semiconductor. *nRF24L01+ Single Chip 2.4GHz Transceiver Product Specification v1.0*. 2008. URL: http://www.nordicsemi.com/eng/content/download/2726/34069/file/nRF24L01P_Product_Specification_1_0.pdf (visited on 05/12/2018).
- [57] ST Microelectronics. *Discovery kit with STM32F072RB MCU*. URL: <http://www.st.com/en/evaluation-tools/32f072bdiscovery.html> (visited on 05/16/2018).
- [58] Raspberry Pi Foundation. *GPIO - Raspberry Pi Documentation*. URL: <https://www.raspberrypi.org/documentation/usage/gpio/README.md> (visited on 05/19/2018).

- [59] Phil Howard. *Raspberry Pi GPIO Pinout interactive diagram*. URL: <https://pinout.xyz/> (visited on 05/19/2018).
- [60] ST Microelectronics. *STM32F072x8/STM32F072xB datasheet*. 2017. URL: <http://www.st.com/resource/en/datasheet/stm32f072c8.pdf> (visited on 05/12/2018).
- [61] The MathWorks, Inc. *Using MATLAB with Python*. URL: <https://www.mathworks.com/solutions/matlab-and-python.html> (visited on 05/13/2018).
- [62] SciPy developers. *SciPy.org*. URL: <https://www.scipy.org/> (visited on 05/13/2018).
- [63] Ondřej Hruška. *GEX USB GPIO platform source code repository*. 2018. URL: <https://github.com/gexpander> (visited on 05/21/2018).



Appendices

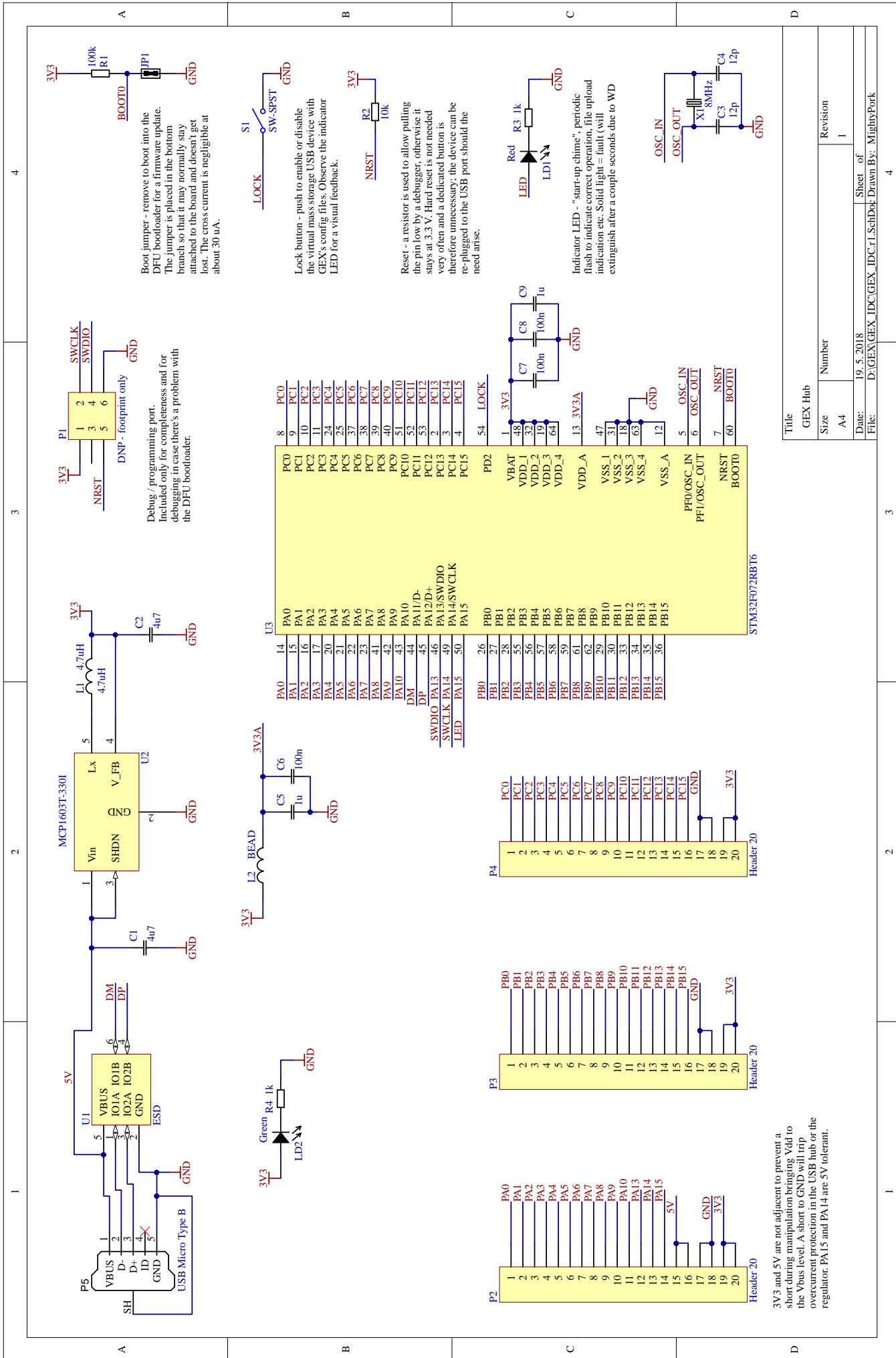

Boot jumper - remove to boot into the DFU bootloader for a firmware update. The jumper is placed in the bottom branch so that it may normally stay attached to the board and doesn't get lost. The cross current is negligible at about 30 uA.

Debug / programming port. Included only for completeness and for debugging in case there's a problem with the DFU bootloader.

Lock button - push to enable or disable the virtual mass storage USB device with GEX's config files. Observe the indicator LED for a visual feedback.

Reset - a resistor is used to allow pulling the pin low by a debugger, otherwise it stays at 3.3 V. Hard reset is not needed very often and a dedicated button is therefore unnecessary; the device can be re-plugged to the USB port should the need arise.

Indicator LED - "start-up chime", periodic flash to indicate correct operation, file upload indication etc. Solid light = fault (will extinguish after a couple seconds due to WD

3V3 and 5V are not adjacent to prevent a short during manipulation bringing Vdd to the Vbus level. A short to GND will trip overcurrent protection in the USB hub or the regulator. PA15 and PA14 are 5V tolerant.

Title		Revision	
GEX Hub		1	
Size	Number		
A4			
Date:	19. 5. 2018	Sheet of	
File:	D:\GEX\GEX_IDC.r1.SchDoc	Drawn By:	MightyPork

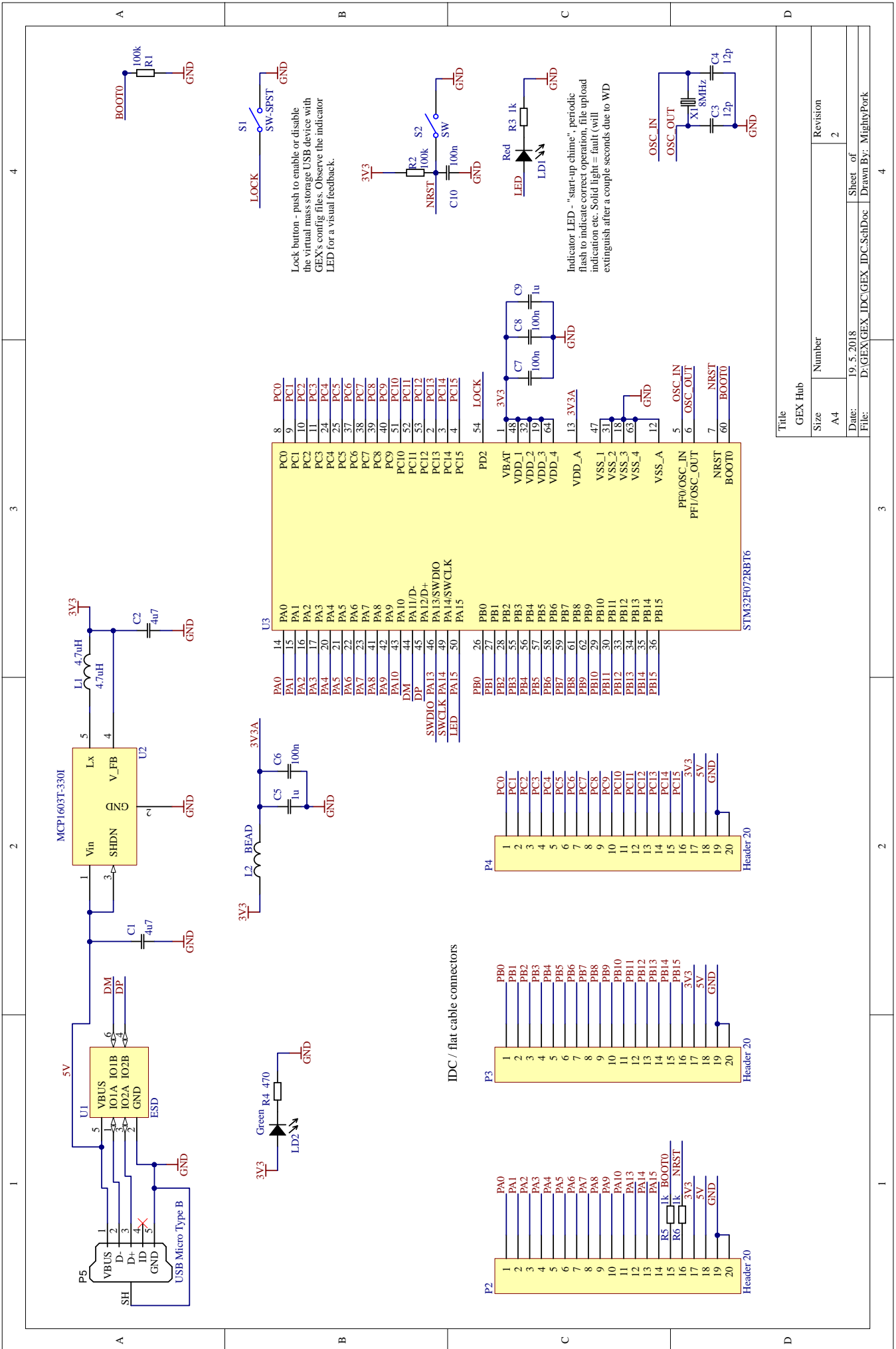

Title		Revision	
GEX Hub		2	
Size	Number		
A4			
Date:	19. 5. 2018	Sheet of	
File:	D:\GEX\GEX_IDC\SchDoc	Drawn By:	MightyPork

