



© 2016 AFCl



Amphenol  
FCI



31



4

PART NUMBER  
10118194-0X0XLF

Item	Title	Q'TY
1	Shell	1
2	Terminal	5
3	Insert/Molding	1

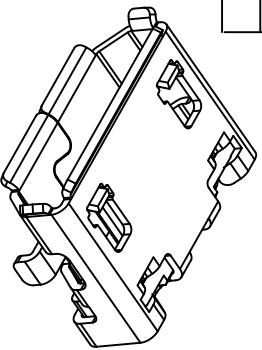
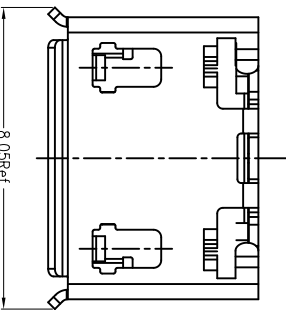

PRODUCT NUMBER DESCRIPTION  
10118194- X X X X L F

1-CONTACT AREA: 0.76um AU  
2-CONTACT AREA: GOLD FLASH

0-WITH FLANGE SEE SHEET 1  
0-WITHOUT FLANGE SEE SHEET 2

0-PLASTIC REEL

0-CARDBOARD REEL

0-COLD SEALING  
0-HOT SEALING

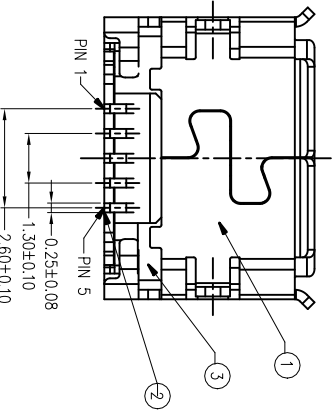
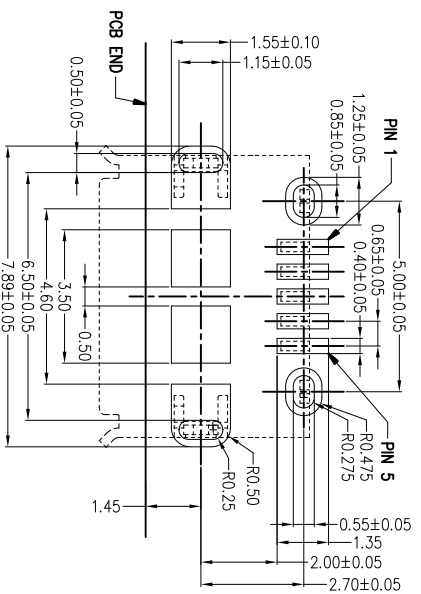
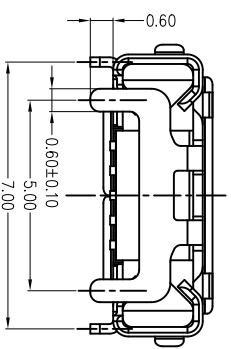
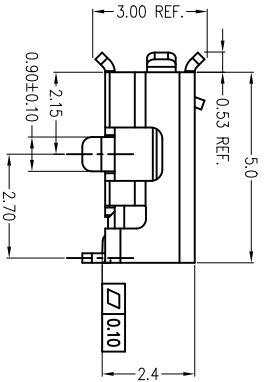
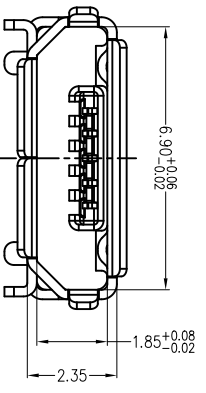

tr	ecn	no	dr	date	surface	tolerance	projection	product family
A	/	LS	10/21/11		ASME Y14.5	ASME Y14.5	MM	HPL_511
B	EX-N-25001	LQ	3/11/16		tolerances unless otherwise specified			MICRO USB B TYPE RECEPTACLE
C	EX-N-25008	LZ	9/29/16	X.F.Z.		XXX±0.10	scale 1:1	
D	EX-N-27008	LZ	05/16/17	dr	JASON_HSU	05/21/11		
				eng	JASON_HSU	05/21/11		
				chr	JASON_HSU	05/21/11		
				ppd	GARY_HSEH	05/21/11		
sheet	revision	D						
index	sheet	1						

form: A4mmXlc-2016-02-24

1

2

3

4

B

A

B

A

5

